

# GRAIN

USER AND SERVICE MANUAL





## PREFACE

SELMI S.r.l. would like to thank you for purchasing our "GRAIN".

This manual is to be considered an integral part of the machine and its purpose is to allow use of the machine throughout its life, from delivery until demolition. Therefore, we suggest that you read it carefully. Everyone working with the machine must read this manual. It is also necessary to keep the manual in a place accessible to operators at all times.

In the event of loss or damage of this manual, please ask SELMI S.r.l. to send you a replacement copy.

The technical information contained in this manual belongs to SELMI S.r.l. and must be considered proprietary.

The total or partial reproduction of the graphic design, text and illustrations is forbidden

With a view to constant technical improvement, the company reserves the right to make any necessary amendments to the content of the manual, to the machine or to parts thereof. Consequently, some of the illustrations may differ slightly from your machine.

This document is an integral part of the "GRAIN", as described in section 1.7.4 of annex I of directive 2006/42/EC.

The Italian edition of this manual contains the original instructions. The foreign language editions are to be considered as translations of the original instructions.

© Copyright SELMI S.r.l.  
Edition January 2017



### EC DECLARATION OF CONFORMITY

The manufacturing company SELMI S.r.l., with main office in S. Vittoria D'Alba (CN) Italy – Via Statale, 151, in its capacity as manufacturer, declares, under its own responsibility, that the machine named:

**"GRAIN"**

Serial number:

is compliant with all the provisions contained in the following directives: 2006/42/EC (machine directive), 2014/30/UE (electromagnetic compatibility) 2014/35/UE (low voltage directive) and EC regulation 1935/2004 (contact with foodstuffs).

The norms adhered to that are used as a reference for the design, realization and testing of the machine are listed in the technical files archived at Selmi Srl.

The manufacturer also wishes to inform you that the technical file may, in the cases envisaged by the directive, be put together by the manufacturing company.

Year of construction:

Date:



The liable person

<b>1. General information</b>	<b>1</b>	<b>3. Moving and transportation section</b>	<b>15</b>
1.1. Structure of the manual	1	3.1. General norms	15
1.2. Messages Used	1	3.2. Packaging	15
1.3. Aim and contents	1	3.3. Transportation	16
1.4. Preservation of the manual	1	3.4. Removal of the packaging	16
1.5. External components	2	<b>4. Installation section</b>	<b>17</b>
1.6. Internal components	3	4.1. Positioning	17
1.7. Details of the manufacturer	8	4.2. Electrical connections	17
1.8. Identification plate of the machine	6	<b>5. Operation section</b>	<b>20</b>
1.9. Identification plate of the CE marking	6	5.3. Using the machine	20
1.10. Inteded use	6	<b>6. Maintenance section</b>	<b>22</b>
1.11. Operating environment	6	6.1. General information	22
1.12. Noise level	6	6.2. General safety practice	22
1.13. Technical characteristics	9	<b>7. Technical diagrams section</b>	<b>24</b>
1.14. Dimensions	9	7.1. Electrical circuit diagram	24
1.15. Storage	10	<b>7. Technical diagrams section</b>	<b>32</b>
1.16. Disposal	8		
1.17. Warranty	8		
1.18. person qualified to operate	9		
<b>2. Safety section</b>	<b>10</b>		
2.1. Safety information	10		
2.2. Safety limitations	10		
2.3. Safety symbols and plaques	11		
2.4. Safety and protection devices	11		
2.5. Client's safety measures	12		
2.6. Personal protection equipment	12		
2.7. Residual risks	13		
2.8. Applied Directives	14		
2.9. Harmonized technical norms	14		

## 1. General information

### 1.1. Structure of the manual

To simplify the reading and understanding of the information contained in this manual and to make searches quicker, it has been divided into sections, each dedicated to a specific subject.

### 1.2. Messages used

#### Attention

This type of message is used to draw the reader's attention to more delicate or particular procedures which, if not carried out correctly, may pose a risk to the safety of the operator and cause damage to parts of the machine.

#### Warning

This type of message is used to draw the reader's attention to procedures which, if not carried out correctly or at pre-set intervals, may cause damage to the machine or its parts, as well as to the product being processed.

#### Environment

Messages relating to the environment draw the operator's attention to the rules to be followed to prevent the risk of environmental damages deriving, directly or indirectly, from use of the machine.

#### Note

These messages highlight instructions, advice and notes that can be particularly helpful during the various uses of the machine.

### 1.3. Aim and contents

This manual has been drawn up in consideration of the requirements of directive 2006/42/EC and paying particular attention to describing all the procedures necessary to obtain the best working conditions for the machine and its operators, without neglecting product quality:

The aim of this manual is, therefore, to provide the user with all the information necessary for the correct use and maintenance of the machine. Consequently it is absolutely necessary:

- to meticulously follow the instructions given in the manual during every phase of the machine's life, from transportation to demolition;
- for every machine operator to thoroughly read the contents of this manual;
- for the company's safety officer to make sure that all machine operators have clearly understood how the machine works

#### Attention

In case of doubts on the correct interpretation of the instructions please contact the manufacturer to obtain the necessary clarifications. All those carrying out any kind of operation on the machine must have thoroughly read and understood the contents of this instruction manual.

#### Warning

If this manual is damaged or lost, please ask the manufacturer or the authorised distributor in the country where the machine is being used for another copy.

### 1.4. Preservation of the manual

The instruction manual is an integral part of the machine and must be used to train and inform professional figures operating on the machine. Consequently, it is necessary to follow certain simple instructions regarding its preservation, as follows:

- store the manual in areas protected from humidity and heat, so as not to jeopardise the quality or legibility of any part of the publication;
- keep the manual in an easily accessible place known to the machine operators;
- avoid handling the manual with dirty or greasy hands;
- if you think it is necessary to highlight important steps of the manual, use non-permanent systems, to preserve its legibility;
- do not remove, rip or rewrite any parts of the manual for any reason.

## External components

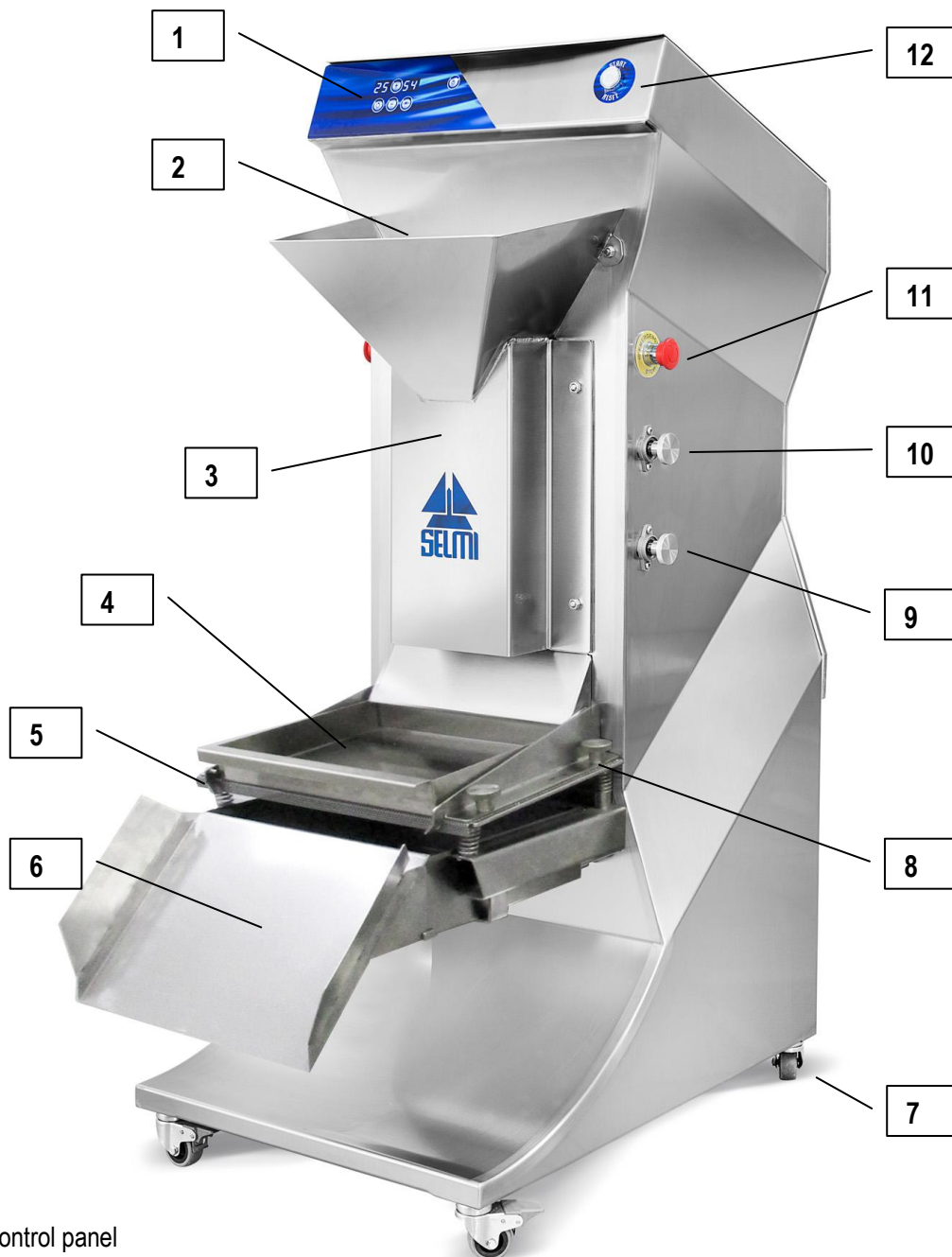

1. Control panel
2. Loading hopper
3. Mill chamber
4. Small tank for to receive the product without selecting it
5. Vibrating grill for the product selection
6. Slope for the product descent into a container
7. Swivelling wheels
8. Knobs holding the grill
9. 2nd Mill aperture setting
10. 1st Mill aperture setting
11. Emergency button
12. Start/Reset button

## Componenti interni

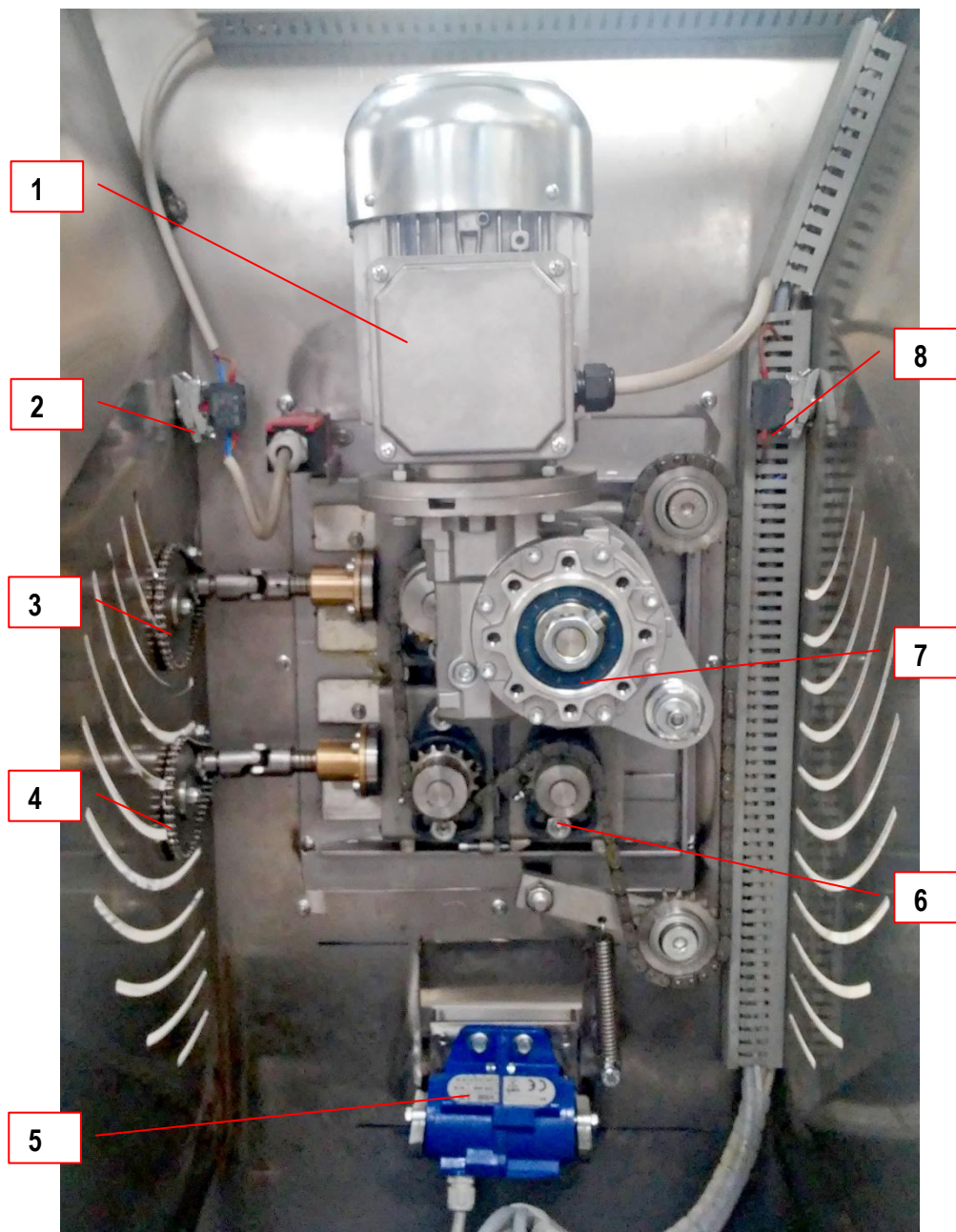

1. Motor
2. Emergency button
3. 2nd Mill aperture setting
4. 1st Mill aperture setting
5. Vibrating motor
6. Gears for the 2 mills movement distribution
7. Reducer



## Electrical panel

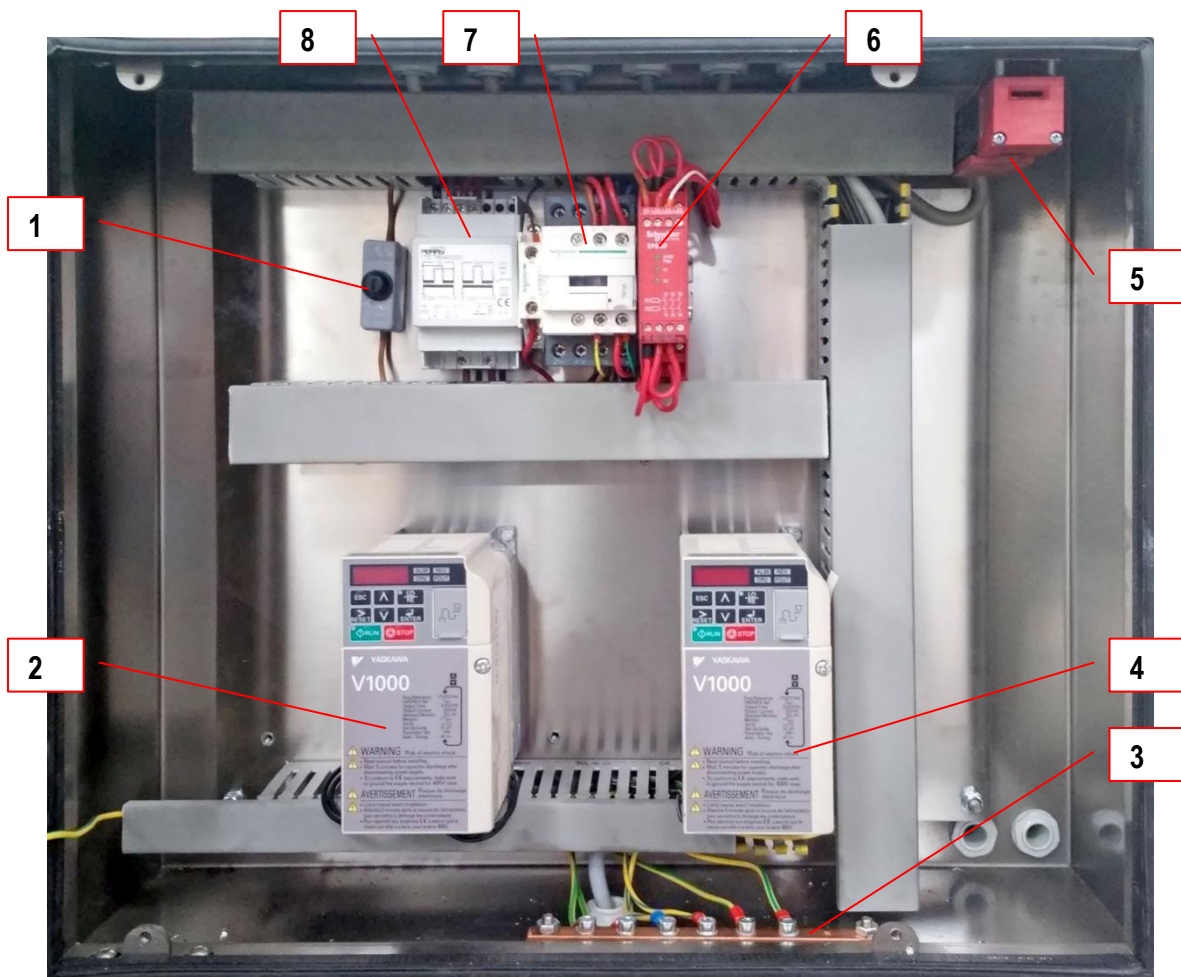

1. Line Protection fuse
2. Mill motor Inverter
3. Ground connection
4. Vibration motor Inverter
5. Micro security electrical panel door
6. Safety module
7. Main contactor
8. Transformer



## Scheda display



1

2

3

4

1. Vibrating motor Inverter
2. Mill motor Inverter
3. Inverter supply
4. 220V board supply

### 1.7. Details of the manufacturer

The machine described in this instruction manual was built by:

SELMI S.r.l.

Via Statale, 151 – 12069 – S. Vittoria D'Alba (CN) Italia  
Tel. 0172.479273 - 0172.479275 - Fax 0172.477814  
www.selmi-group.it - info@selmi-group.it

### 1.8. Identification plate of the machine (CE marketing)

There is a plate, similar to the one shown here, on the machine, indicating details of the manufacturer, the CE conformity mark and the machine's serial number. Always state this number when communicating with the manufacturer.



Example of identification plate on the machine structure

**TYPE**  
**SERIAL NUMBER**  
**YEAR**  
**WEIGHT**

### 1.9. Identification plate of the CE marking electric panel (low voltage)

Example of identification plate on electrical panel. For the correct data, see the section on the machine's technical specifications.

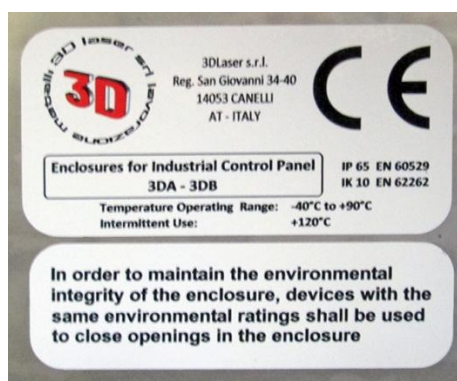

### 1.10. Intended use

Third component of the Selmi Bean to Bar range, this machine has the specific task of grinding the cocoa nibs in particles of size between 200 and 250 microns. The product, once inserted into the hopper, is crushed by stainless steel pins to obtain a "pre-refined" paste. Versatility and ease of use allow this machine to be used also for the refining of dried fruit, constituting an excellent alternative to the vertical cutter.

#### Warning

**A use other than that specified is considered improper. The machine is intended for professional use only.**

#### Attention

**Do not place any small objects near the control panel or the tank: they could fall and enter the tank, which would contaminate the product.**

### 1.11. Operating environment

To guarantee proper functioning the machine must be protected from atmospheric agents. Its ambient operational temperature should be between 15C° and 35C° with relative humidity not exceeding 70%.

The working environment must be clean, sufficiently illuminated and away from an explosive environment.

The environmental characteristics of the installation site are specified in section 4.

#### Attention

**The machine's fixed guards have a variety of openings to allow the internal units to cool. When the machine is running, make sure that these openings are not covered by cloths or objects that obstruct proper air flow.**

### 1.12. Noise level

The phonometric tests carried out on this specific machine model show an acoustic pressure lower than **70 dB(A)**.

**Technical characteristics**

Steel:	inox AISI 304 L
Weight:	200 Kg
<b>Electrical characteristics</b>	
Power at maximum load:	4,5 kW 16A
Supply voltage:	230V
Phases:	1
Frequency:	50Hz or 60Hz
Protection:	IP65
Production	70 Kg/hour

\* This data may change according to the installation conditions required under the contract. For the correct data please refer to the label located inside the electrical panel.

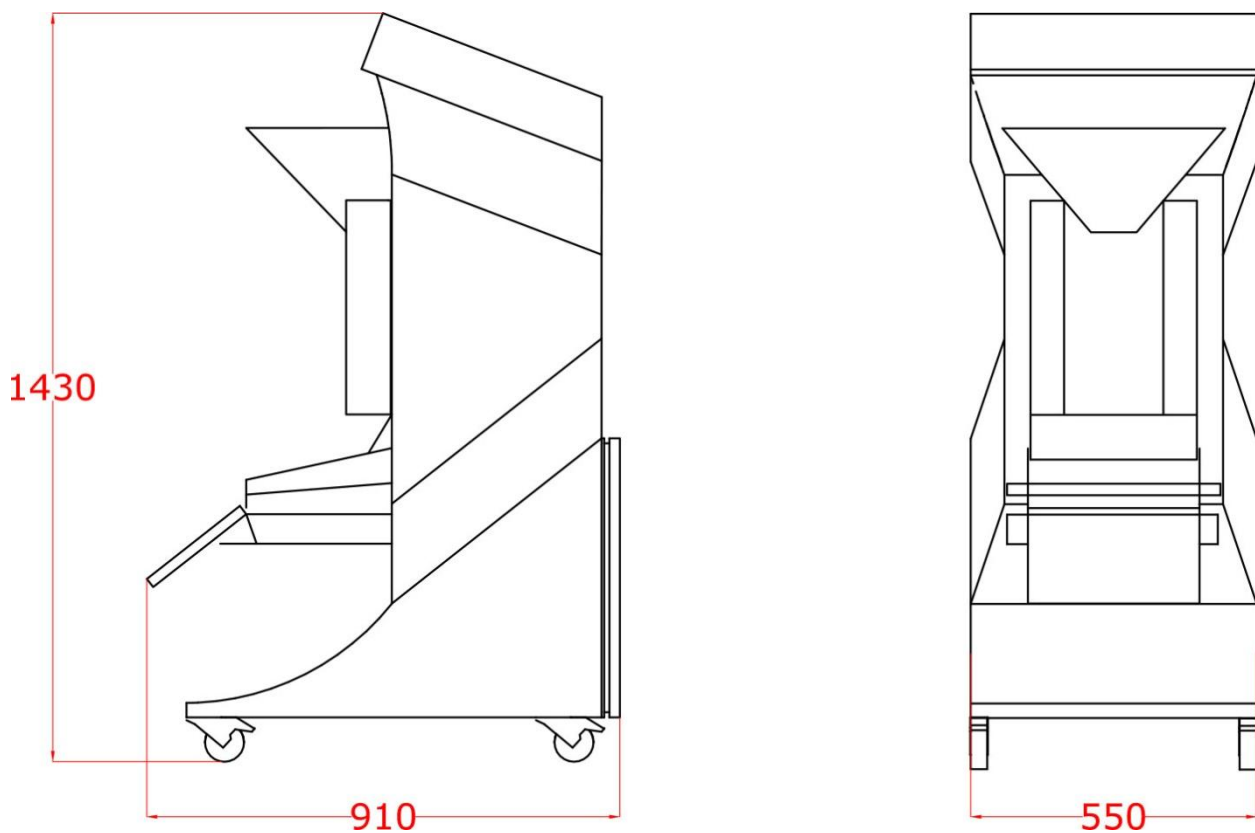
**Dimensions:**

### 1.15. Storage

Remove the remaining product left in the machine following the instructions in the appropriate section. Stop the machine using the main switch and disconnect it from the electricity main. Move it to a spacious place (it is necessary to work all around the machine).

#### **Attention**

**It is absolutely necessary to follow the instructions in order to insure the safety of the operators and to avoid damaging the machine's removable parts.**

Use a brush to cover the movable components and the mechanical moving parts with a thin layer of food grade lubricant. This can later be removed with an alkaline de-greaser (Sodium Hydroxide) if the machine needs to be re-installed.

Carry out the same operation on the machine surfaces, taking care of avoiding the heating elements located in the inner part of the machine.

Gather the parts (use as reference the delivery packing list) and put them in the original packaging. Place packets of hygroscopic salt based on silica gel in the packaging.

Store all the parts in a sheltered place away from atmospheric agents and in temperatures from 0° C to 40° C. Cover the parts with nylon in order to prevent the accumulation of dust.

### 1.16. Disposal

Disposal will occur at the end of the working life of the machine, which under normal conditions of use and maintenance will be over ten years.

In the case of disposal all the components of the machine will have to be disposed of in adequate waste yards according to the legislation in force.

Before disposal it will be necessary to separate the plastic or rubber parts and the electrical and electronic material.

#### **Environment**

**Parts made solely of plastic, aluminium and steel can be recycled in the appropriate collection centres.**

**According to the RoHS regulations electronic boards and electric material should be recycled separately in authorised collection centres.**

### 1.17. Warranty

The manufacturer offers a warranty on this machine model for a period of 24 months from the purchase date, as shown on the fiscal document issued at the time the machine is delivered.

The warranty will be void if the machine is repaired by a third non authorized party or if fixtures and accessories not supplied by or recommended or approved by the manufacturer are used.

The warranty will also be void upon removal or alteration of the plate showing the serial number and other data.

Within the warranty period the manufacturer will repair or replace, free of charge, parts that are faulty due to manufacturing.

In case the repair has to take place at the manufacturer's site, the machine will have to be sent to the manufacturer in its original packaging.

Transportation expenses will be covered by the manufacturer during the warranty period.

The warranty does not cover the cleaning of the functioning parts.

Defects not clearly attributed to the material or the manufacturing will be examined. If the claim should turn out to be unjustified all repair expenses, changed parts and transportation will be charged to the buyer.

The warranty does not cover damage caused by the following:

- accidental damage during transportation
- damage due to lack of care or procedures carried out incorrectly
- damage due to improper use not conforming to the warnings of the user and service manual
- components subject to wear and tear; a detailed list is available in the components section.

Structural damage, modifications, improper alterations or repairs can affect the functioning of the safety mechanisms, thus making the declaration of conformity and warranty void. Alterations on the machine can be carried out solely by technicians authorised by the manufacturer.

### 1.18. Professional personnel qualified to operate the machine

The machine must only be used by authorized and purposely trained personnel; the same precautions are also applicable to personnel who carry out maintenance.

Personnel who do routine and extraordinary maintenance must be specially trained professionals; good knowledge of the machine is needed for extraordinary maintenance.

#### **Attention**

**Do not permit others to approach the machine during its use or maintenance.**

The following professional people, after having received all the necessary instructions, are the only ones allowed access to the machine:

#### **Safety officer**

The safety officer is responsible for protection and prevention of risks in the workplace, as is mentioned in European Directive 89/391/EEC (Safety in the workplace), introduced in Italy with the 12/11/1994 Legislative Decree.

It is the responsibility of the safety officer to make sure that all personnel who use/maintain the machine have received all the instructions regarding their relative roles contained in this manual.

#### **Operator (user of the machine)**

Operator trained and qualified for the use of the machine (working cycle, potential adjustments, etc.).

He/she can only carry out the specific tasks described in this manual reserved for this role.

#### **Mechanical maintenance technician**

The technician is qualified to use the machine as the OPERATOR and furthermore to use it with the protection disabled, to attend to the mechanical parts for adjustments, maintenance and reparations.

He/she is not qualified to act on live electrical installations.

The mechanical maintenance technician must have a generic knowledge of the machine and a specific knowledge on this machine model.

#### **Electrical maintenance technician**

The technician is qualified to use the machine as the OPERATOR and furthermore to use it with the protection disabled, to attend to the adjustments and electrical installations for the purposes of maintenance and repair.

If qualified, he/she may work when the electrical panels, control devices, are live, provided he/she uses appropriate personal protective devices.

The electrical maintenance technician must have a generic understanding of the electrical panels and specific knowledge on the electrical panel and components of this machine.

#### **Manufacturer**

The manufacturer's personnel are qualified to perform all of the above-described operations.

Any operations not described in this manual may be performed ONLY by personnel authorized by the manufacturer.



## 2. Safety section

### 2.1. Safety information

#### **Attention**

The safety officer has the obligation to inform the workers on the risks related to the use of the machine.

Furthermore the employer must inform, educate and train the user according to statutory laws.

The lack of compliance with the basic norms or precautions could result in accidents during the functioning, maintenance or reparations of the machine. Accidents can often be avoided by acknowledging potential hazardous situations before they materialize. The operator must pay attention to the potential dangers and have the training, the competence and the necessary equipment to deal with these tasks correctly.

The manufacturer cannot be held responsible for accidents or damages resulting from the use of the machine by personnel not adequately trained or having used the machine improperly, as well as the lack of, even partial, compliance to the safety norms and interventions procedures contained in this manual.

The safety precautions and the warnings messages, the operator could be subject to accidents with serious consequences for himself and for other people.

In cases where tools, procedures, work methods or working techniques not explicitly suggested by the manufacturer are used, it will be necessary to make sure that no dangers are present for the individual carrying them out and to other alike.



Use exclusively original SELMI spare parts. The manufacturer will take no responsibility for accidents or damages in the case of use of non-original spare parts.

If a tool not supplied by the manufacturer is installed on the machine, the client needs to make sure that the norms stated in Directive 2006/42/EC are adhered to. If this new tool introduces new risks to the system then the new system must be re-certified. In any case the manufacturer cannot be held responsible for accidents or damages caused by the machine if it has been modified or equipped with non original accessories.

### 2.2. Safety limitations

#### **Attention**

The indications mentioned hereafter cannot completely safeguard from all dangers that one might encounter while using the machine; they must be used in conjunction with common sense and the experience of the operator, the only indispensable measures for the prevention of injury.

Every section has a list of specific safety measures for different operations. The safety measures mentioned here below are generic and should be followed for all procedures on the machine.

The responsibilities assigned to specific people concerning the use of the machine must be clearly defined as stated in the "Qualified Personnel" section.

#### **Attention**

The use of the machine is forbidden to personnel who have not been authorised or trained by the safety officer. Consult the manufacturer before carrying out procedures that are not mentioned in this manual.

Prolonged overloads or anomalies can cause the electric motors and electrical appliances to overheat with resultant harmful fumes. In such cases immediately disconnect the machine from the mains and do not approach the machine until such fumes have been dispersed via adequate ventilation. In case of fires do not use water jets on the machine – use CO2 extinguishers instead.

The operator, any helping technician and the maintenance technician must use the appropriate personal protection equipment when working on the machine.

It is forbidden to climb on the machine.

Do not touch the electrical wires, switches, buttons etc. with wet hands.

The parts subject to wear and tear during the functioning of the machine must be checked and replaced as soon as they present noticeable signs of wear and tear.

The manufacturer has designed and built the machine to last for a reasonable time with the Client's normal conditions of use in mind; it is however necessary to periodically check the components and the structure of the machine, paying attention to any anomalous conditions, such as, for example, cracks or deformations. If necessary, contact the manufacturer to ask for a complete check of the machine.

Please consult Section 4 (Installation) for the working environmental conditions of the machine.



**2.3. Safety symbols and plaques**

The machine has a number of plaques with symbols and/or safety messages stuck to it.

**Attention**

**Make sure that all the safety messages are legible and in good condition.**

Replace the damaged plaques with the new ones from the manufacturer. If a plaque happens to be on a part that is being replaced, make sure that a plaque is present on the new piece.

**ATTENTION**

**THE PERFORMANCE OF WORK ON ELECTRICAL EQUIPMENT CONNECTED TO THE POWER SUPPLY IS STRICTLY FORBIDDEN**

- ANY EXCEPTIONS MUST BE AUTHORISED BY THE EXECUTIVE MANAGER
- IN PARTICULARLY DANGEROUS SITUATIONS, ANOTHER PERSON MUST BE PRESENT IN ADDITION TO THE PERSON PERFORMING THE WORK

**WORK MAY ONLY BEGIN WHEN THE SAFETY MEASURES HAVE BEEN IMPLEMENTED**

**IN OBSERVANCE OF PRESIDENTIAL DECREE 543 ON THE PREVENTION OF ACCIDENTS**



(positioned on the door of the electrical panel)



Label indicating compulsory reading of the manual (positioned on the front of the machine)

**2.4. Safety and protection devices**

**Attention**

The components shown here are particularly important for the safety of the operator and the machine. In cases of malfunction or wear they must be replaced with spare parts supplied or authorized by the manufacturer.

While the machine is in use all the protection devices must be correctly installed.

The safety devices present on the machine are:

- Mushroom emergency button with mechanical unblock mechanism.



There is an emergency stop mushroom button on the machine. Pushing it cuts voltage to all live parts by means of appropriate devices. To reset it, release the emergency button by turning its head and then push the RESET button shown in the photo.

Before starting every shift, press it to make sure that it works properly.

- *Protective devices*

The machine is equipped with protective plates that can be removed with a tool to allow access to the inside of the machine in order to carry out maintenance operations.

The fixed protective plates are screwed into position and can be removed with the appropriate tool; if the screws are removed the fixed protective plates will not remain in place and must be placed on the floor.

All the protective plates have smoothed and rounded edges for the safety of the exposed individual and of the operators.

The protective plates have loss-proof screws that remain attached to the plate when it is removed from the machine.

### **Attention**

**Do not switch the machine on if the protective panels are removed or not correctly fixed into position with the appropriate screws.**

**Do not forget to remove cloths, keys or utensils used for the maintenance operation from within the machine.**

Before closing with the protective panels and switching on the machine check carefully and if necessary remove any extraneous objects which may be present inside the machine.

All protection and safety devices must always be kept in perfect working conditions. If faulty, they must be immediately repaired or replaced.

The replacement, disengagement, partial or total removal of the protective plates, safety devices and protective structures must only be carried out during maintenance operations. This also applies to the safety plaques attached to the side of the machine.

## **2.5. Client's safety measures**

The client must arrange for the following safety measures to be in places:

Provision of an adequate location for installation, paying particular attention to the characteristics below:

- Adequate flooring
- Normal and emergency lighting
- Adequate ventilation
- Clearly signposted emergency exits
- Provision of mains voltage connection with associated safety devices, conforming with the norms in force and the characteristics of the machine
- Adequate means for the collection and subsequent disposal of residues, even hazardous or special ones (oils and grease, broken or waste material, etc.).
- Adequate fire safety systems and equipment
- Prohibition of entry into the installation area to non authorized personnel

The customer must also provide for:

- Training of the operators and the maintenance technicians
- Training for the operators on the basic functioning of the machine and emergency devices
- Provision of personal safety equipment to protect the operator and the hygiene of the product
- Checking the qualifications of external maintenance technicians potentially called to work on the machine
- Keeping of a maintenance log book

The employer is also responsible for checking that the operators correctly carry out the procedures explained in this manual.

## **2.6. Personal protection equipment**

The operators who carry out functions on the machine must receive appropriate instructions on the use of personal protection equipment such as shoes, gloves, etc... which will protect them from residual risks derived from the execution of various activities. The operators must furthermore be equipped with protection equipment for hygiene purposes (caps or hair nets, gown, etc...).

If the noise level in the working environment surpasses 85dB (A) appropriate ear protection must be used.

### **Warning**

The clothing of whoever operates or carries out maintenance on the machine must conform to the essential safety requirements defined by European directive and the laws in force in the country in which the machine is installed.

### **Attention**

During maintenance operations individuals must wear adequate clothing to prevent the occurrence of accidents.

In order to avoid mechanical risks such as snagging or dragging, it is prohibited to wear particular objects such as bracelets, watches, rings or necklaces during the working cycle and during maintenance operations.

## **2.7. Residual risks**

The accurate risk analysis carried out by the manufacturer and archived in the technical file has eliminated most of the residual risks, which are nevertheless present during the use of the machine, to acceptable levels.

The manufacturer's recommendation is to meticulously adhere to the instructions, procedures and recommendations contained in this manual.

### **Attention**

It is strictly prohibited to carry out any type of mechanical or electrical modification so as not to create added dangers and unforeseen risks.

### **Attention**

During cleaning and maintenance operations and during the work cycle, do not allow the product inside the tank to come into contact with water or other fluids.

### **Attention**

If the machine remains unused for long periods of time please take note of the expiry date of the product remaining inside the machine. Upon restarting the processing only insert new chocolate if the product already in the machine has not expired. If the old product has expired, proceed to empty and clean the machine before inserting the new product.

### **Attention**

Keep the machine with the residual chocolate inside the tank in an adequate environment with temperatures ranging from 10 °C to 25 °C.

The residual risks present on the machine are:

#### *Risks during machine transportation*

It is recommended to fasten the machine, or its parts, at the dedicated locations and lift it with appropriate means to the minimum permitted height, proceed at low speeds and make sure that the people helping with the moving are at a safe distance from the moving object. Before moving the machine make sure that the passage is clear and that there are no objects placed on the machine. It is important that the means of support and transportation is controlled by a person qualified for such a role, so as to avoid unforeseen movements which may be dangerous to the people in the vicinity who are helping with the moving.

#### *Risks of faults to the circuits of signalling, safety, protection and emergency stop*

In the case of a circuit fault, the safety and signaling circuits, the anti-injury protections and the emergency stop can lose their effectiveness, therefore it is asked that their functionality is periodically checked.

#### *Identified residual risks and information plaques*

The manufacturer has placed on the machine danger and/or warning plaques, based on the residual risks, with pictograms in compliance with the norm pertaining to the display of graphic symbols on the machine.

The user should immediately replace these plaques if they are not clearly legible.

### **Attention**

**It is expressly forbidden to remove the safety and/or warning plaques placed on the machine. The manufacturer will not take any responsibility on the safety of the machines if this is not observed.**

#### *Risk to life (electro locution)*

Before commencing work on any electrical appliance it is necessary to disconnect the machine from the mains. If it were to become necessary to work within the electric panel by bypassing the electricity cut off devices, then the work must be carried out exclusively by specialized personnel.

#### *Risk of spreading fire*

In case of fire never use jets of water in the vicinity of the apparatus. Disconnect all connections to the mains and use the appropriate CO2 extinguishers located in the building.

### **2.8. Applied Directives**

The following directives apply to the machine described in this manual:

- 2006/42/EC machinery Directive
- 2014/30/UE Directive for electromagnetic compatibility
- 2014/35/UE low voltage Directive

And the regulation:

- 1935/2004 EC regulation for materials in contact with foodstuffs

### **2.9. Harmonized technical norms**

The machine was designed and tested to conform to the "essential requirements to health and safety" present in attachment I of European Directive 2006/42/EC.

The norms used as reference for the design, the realization and the testing of the machine are listed in the technical file archived by the manufacturer.

### 3. Moving and transportation section

#### 3.1. General norms

Before moving the machine always check the weight and general instructions shown on the packaging. Personnel not responsible for the movement of the machine must not remain in the area needed for movement.

#### 3.2. Packaging

The machine is delivered on a platform, secured by means of straps and placed inside a cardboard packaging which is also secured to the platform by means of straps. An example of the machine packaging is shown in the picture below.



Instructions for transportation are on the sides of the packaging.

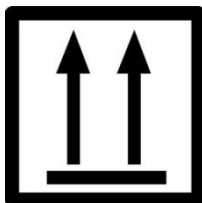

The first symbol shows the correct upright position of the packaging;



the second symbol shows that the packaging must be protected from the rain;



the third symbol shows that the content of the packaging is fragile and must be handled with care. On two sides of the packaging there is a device called "TILTWATCH", which can determine if the packaging has been tilted to such an extent that the content may have been damaged; it is necessary to pay attention to the instructions given on the adhesive label. If the machine has been excessively tilted during transportation (the dot at the centre of the TILTWATCH device will be red) some components could have been damaged.



**Attention**  
The manufacturer's warranty does not cover damage during transportation; the buyer should follow the instructions on the adhesive label in order to avoid disputes.

### 3.3. Transportation

To transport the machine it is necessary to use a suitable vehicle equipped with a platform to lift the load; the platform must be adequate for the weight of the machine, which is stated in the technical characteristics section (section 1.13).

When the machine, still in its packaging, is in the body of the lorry, it can be carried to the lifting platform only by means of a manual transportation trolley for euro pallets.

The lifting platform has to be equipped with side rails in order to prevent the machine from falling when it is still high off the ground.

The machine can be lowered to the ground from the platform only after having lowered the manual trolley. The machine should be lowered slowly from the platform, avoiding shaking and sudden stops which could cause a loss of stability.

After having completed the unloading procedures, the machine should be moved exclusively by means of a manual transportation trolley adequate for euro pallets; the platform should only be lifted to the height needed to move the machine.

Before moving the machine verify that the passage to the final destination is clear.

#### **Attention**

**Do not go on very steep ramps which could cause the loss of control of the trolley.**

### 3.4. Removal of the packaging

Cut the straps that anchor the cardboard to the platform; remove the cardboard and put it out of the way.

Cut the straps that hold the machine to the platform, remove the machine's plastic cover and unravel the accessories provided.

Carefully lift the front of the machine and remove the wooden slat blocking the front wheels; subsequently remove also the wooden slat blocking the rear wheels by lifting the back of the machine.

Very carefully lower the machine from the platform.

#### **Note**

**Keep the original packaging; it may be necessary to use it if the machine needs to be sent to the manufacturer for extraordinary maintenance or repairs.**



## 4. Installation section

### 4.1. Positioning

#### **Warning**

Before positioning the machine check that the machine, the associated accessories and the parts supplied separately have not been damaged during transportation.

It is the task of the Client to make sure that the strength of the supporting surface, at the point of installation, is adequate for the weight of the machine.

The flooring at the point of installation must be sufficiently level.

Isolate the machine from any potential vibrations coming from other nearby machinery.

In the case where the machine or any of the associated accessories are found damaged it is important to alert the manufacturer of the found anomaly so as to agree on the actions to be taken.

#### **Attention**

The machine must be placed on a level surface; for the other environmental requirements necessary for optimal functioning of the machine please see sections 1.11 and 2.5..

### 4.2. Electrical connections

#### **Attention**

The connection of the machine to the electrical system must be carried out by personnel observing the legislation in force; the characteristics of the electrical connection must be compatible with the electrical specifications of the machine which can be found in the relevant section or on the opposite plaque on the door of the electric panel.

#### **Attention**

If the machine has been purchased to be powered by a three phase line, make sure that in the socket there is a connection to the neutral wire. This is necessary for the functioning of the machine.

#### **Attention**

Before starting any procedure make sure that there are no objects inside the hopper.

#### **Attention**

This operation should be carried out by a technician or by a maintenance electrician.



## COMMAND DESCRIPTIONS

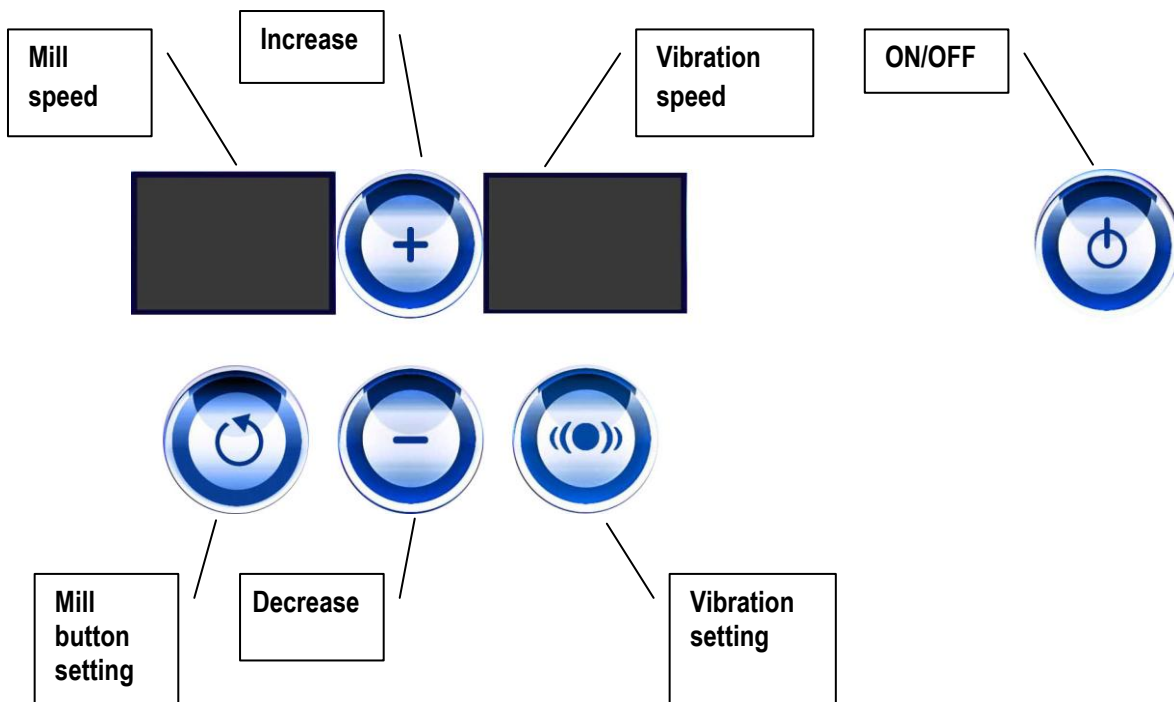

## HOW TO WORK WITH THE MACHINE



**1 - When the machine is installed, PUSH START RESET BUTTON.**



**2 - PUSH ON /OFF BUTTON**

To switch on the displays push the button ON / OFF.

During the work if you push the ON/OFF button the machine will go in standby.



**3 - GRINDER BUTTON**

Push to switch ON/OFF the grinder.

To change the vibration intensity:

- hold pressed the button till the display will pulse;
- with + and - increase or decrease the intensity.



**4 - MILL BUTTON**

Push the button to switch ON/OFF the mill.

To change the rotation speed:

- hold pressed the button till the display will pulse;
- with + and - increase or decrease the speed.

## HOW TO WORK WITH THE MACHINE

The machine can work with dried fruit roasted.

1 - Place a container in order to receive the paste



1 - Load the product into the loading hopper



2 - The product, once inserted into the hopper, is crushed to grains.



### MILL APERTURE SETTING



#### TO SET THE GRAINS DIMENSION

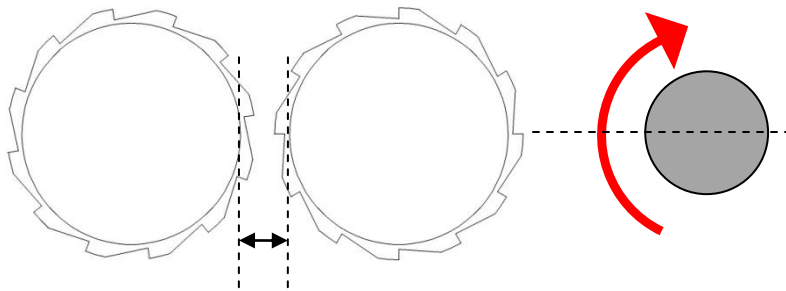

Rotate clockwise the 1 and 2 knobs to make bigger grains

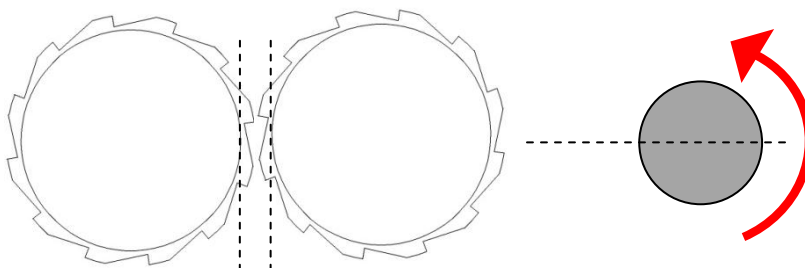

Rotate anticlockwise the 1 and 2 knobs to make smaller grains

## 6. Maintenance section

### 6.1. General information

#### **Attention**

The product present in the tank or internally to the machine must NEVER come into contact with water or other liquids: this may lead to the formation of moulds and bacterial loads.

#### **Attention**

If a bacterial presence is found on the product derived from the processing carried out with this machine model it will be necessary to stop production immediately and contact the manufacturer for the disinfection procedures.

Before carrying out maintenance or cleaning procedures on the machine, cover the tank with the supplied lid.

Never clean or lubricate components in motion.

#### **Warning**

Extraordinary maintenance on the machine is exclusively carried out by the technicians approved by the manufacturer.

The training course carried out only gives the client the base instructions for ordinary maintenance. The manufacturer suggests carrying out a full service every two years to guarantee the safety conditions.

#### **Note**

The maintenance technician must note on an appropriate logbook all the interventions carried out on the machine.

This section describes the ordinary checking and maintenance procedures needed to guarantee the correct functioning of the machine.

Any other intervention that may be necessary to eliminate anomalies or faults must be expressly authorized by the manufacturer.

For major repairs it is recommended to turn to the manufacturer whose specialized personnel, possessing the technical expertise acquired from the original manufacturing in the factory, are always reachable and able to intervene quickly.

For maintenance or replacement of commercial components installed on the machine keep to the instructions provided directly by the manufacturers.

Such instructions are normally attached to the components or obtainable via catalogues or manuals provided by the manufacturers.

#### **Environment**

The components replaced during maintenance operations must be disposed of according to the laws in force concerning waste materials. If necessary, they can be sent to the manufacturer, who will dispose of them in the most appropriate manner.

### 6.2. General safety practice

#### **Attention**

Before starting a maintenance procedure disconnect the machine from the mains and put in place all the necessary safety measures.

#### **Attention**

During maintenance procedures place on the machine, preferably on the control panel but in any case in a clearly visible location, a sign with the text: "MACHINE UNDER MAINTENANCE, DO NOT SWITCH ON".

Maintenance work must be carried out by specialized technicians who are trained in specific sectors, which for this machine are:

- mechanical maintenance technicians;
- electrical maintenance technicians.

It is the duty of the Safety Officer to ascertain the professionalism and competence of the maintenance technicians.

Before starting a maintenance procedure the safety officer must:

- 1) Clear the working area of extraneous materials and people.
- 2) Make sure that the necessary tools are conveniently available to the maintenance technician and that they are in good condition.
- 3) Make sure that the lighting is sufficient and provide, if necessary, portable low voltage lights.
- 4) Make sure that the maintenance technician is equipped with the necessary approved personal protection equipment for the specific operation (gloves, safety glasses, shoes, etc.).
- 5) Make sure that the maintenance technician has carefully read the instructions contained in this manual and has excellent knowledge of how the machine works.



At the end of every maintenance intervention the following procedures need to be carried out before restarting the machine:

- 1) Carefully clean the floor in the work area, removing any residues that may cause slippage
- 2) Lock the protective panels back into place, check the functionality of the interlocking parts and of the safety devices. Make sure to re-activate them if they were previously deactivated
- 3) Make sure that no extraneous components have been left in the machine, especially mechanical parts, utensils or components used for maintenance that could cause damage to the machine or put personnel at risk.
- 4) Before switching the machine back on make sure that all personnel are at a safety distance.
- 5) Before restarting the processing, the maintenance technician must check the entire working cycle, the functionality of the safety mechanisms and the integrity of the fixed protective panels.
- 6) before restarting the working cycle the machine must be cleaned according to the instructions in section 6.3.

### **Attention**

**Following every maintenance intervention it is the Safety Officer duty to ascertain that the machine is working properly and that all the safety devices are present and functional.**

Unless expressly required for the solution of a breakdown, never interfere with the adjustments and positioning of the limit microswitches; their tempering can cause serious damage to the machine and pose risks to the operator.

Before assembling a block always cover with a thin layer of alimentary grade oil the internal parts and coupled surfaces. replace all the seals and gaskets with original parts before reassembling the components.

### **Note**

**Before reinstalling the machine components that have been washed with water or other liquids, check that they are completely dry.**

Work on electrical components must only be carried out by the electrical maintenance technician specially trained and authorized by the Safety Officer.

## 6.4. ORDINARY MAINTENANCE

### MILLS CLEANING

**Attention**

Before starting a maintenance procedure disconnect the machine from the mains and put in place all the necessary safety measures.

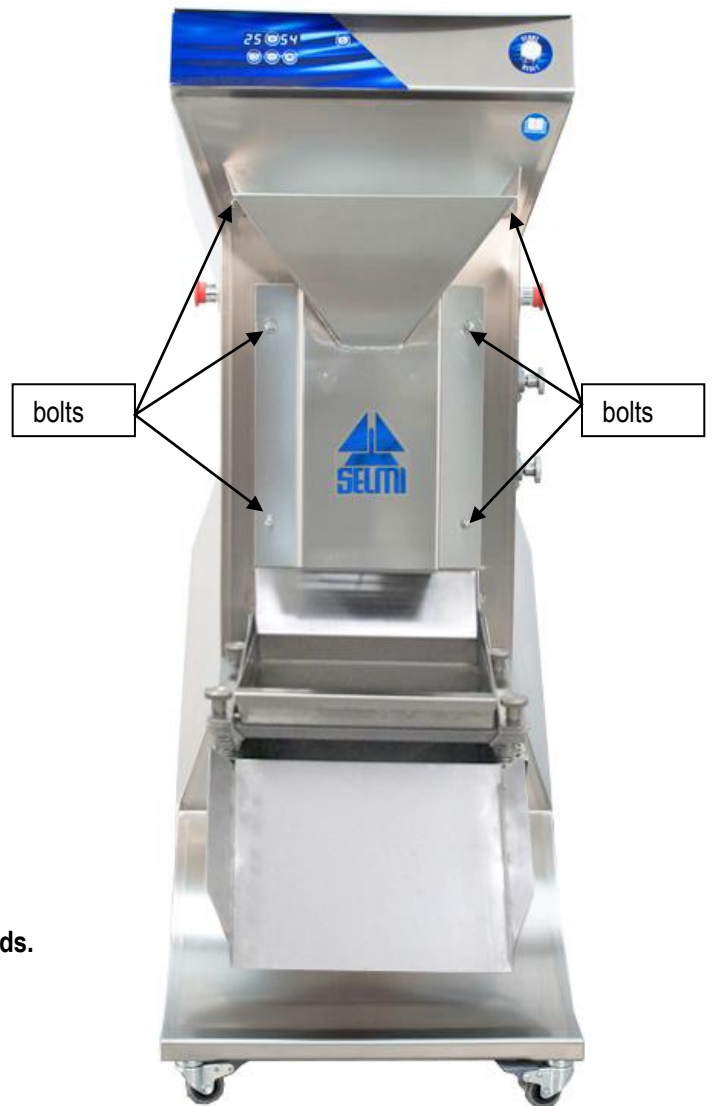

1. Unscrew the 6 bolts that hold the front protective panel.
2. Remove the protection panel.
3. Clean the mills.
4. After cleaning replace the panel and screw the 6 bolts.

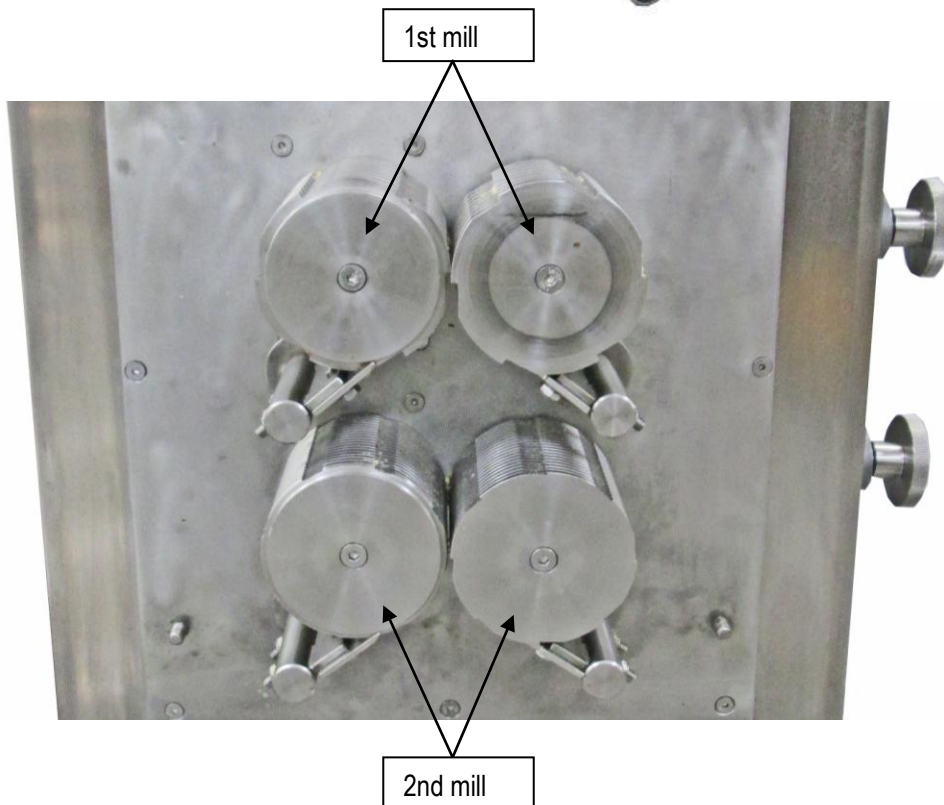

GRILL CLEANING

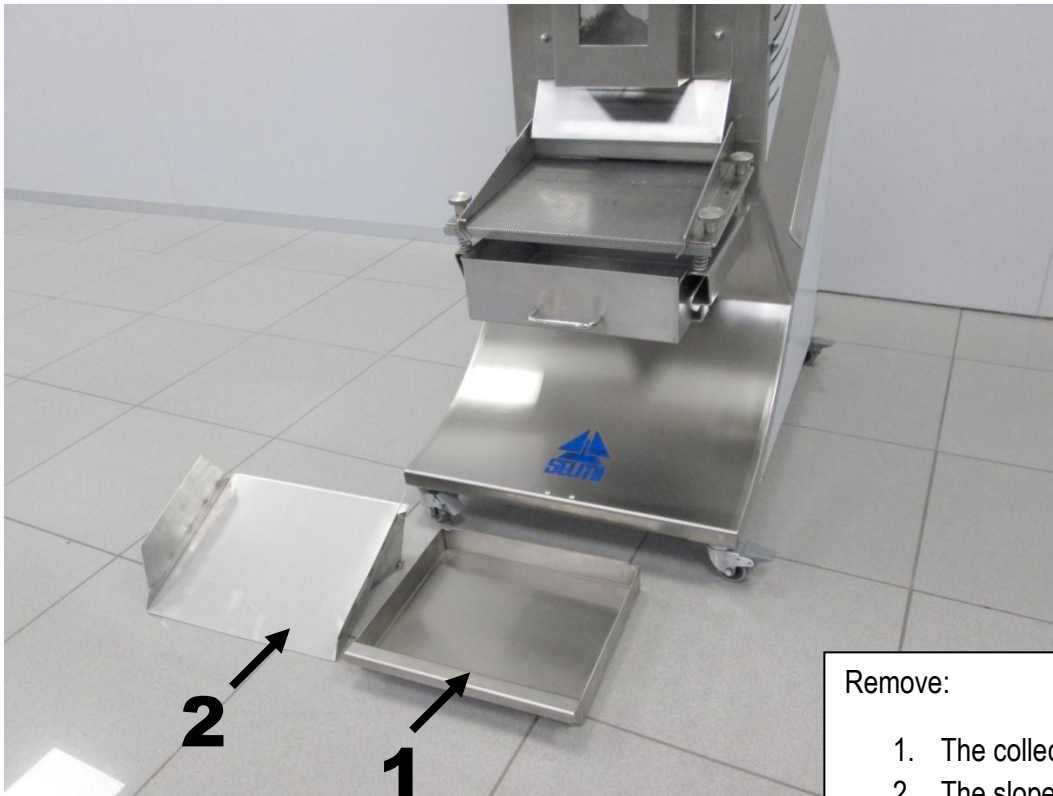

Remove:

1. The collecting tank
2. The slope

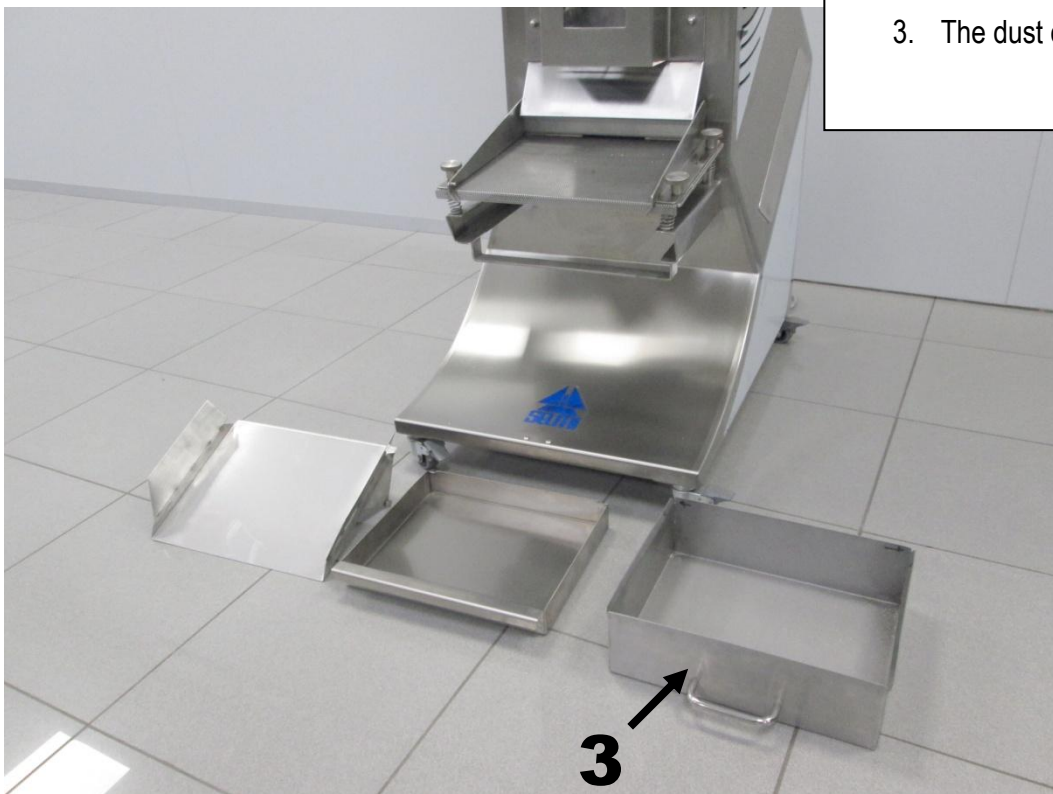

Rimuovere:

3. The dust collecting tank

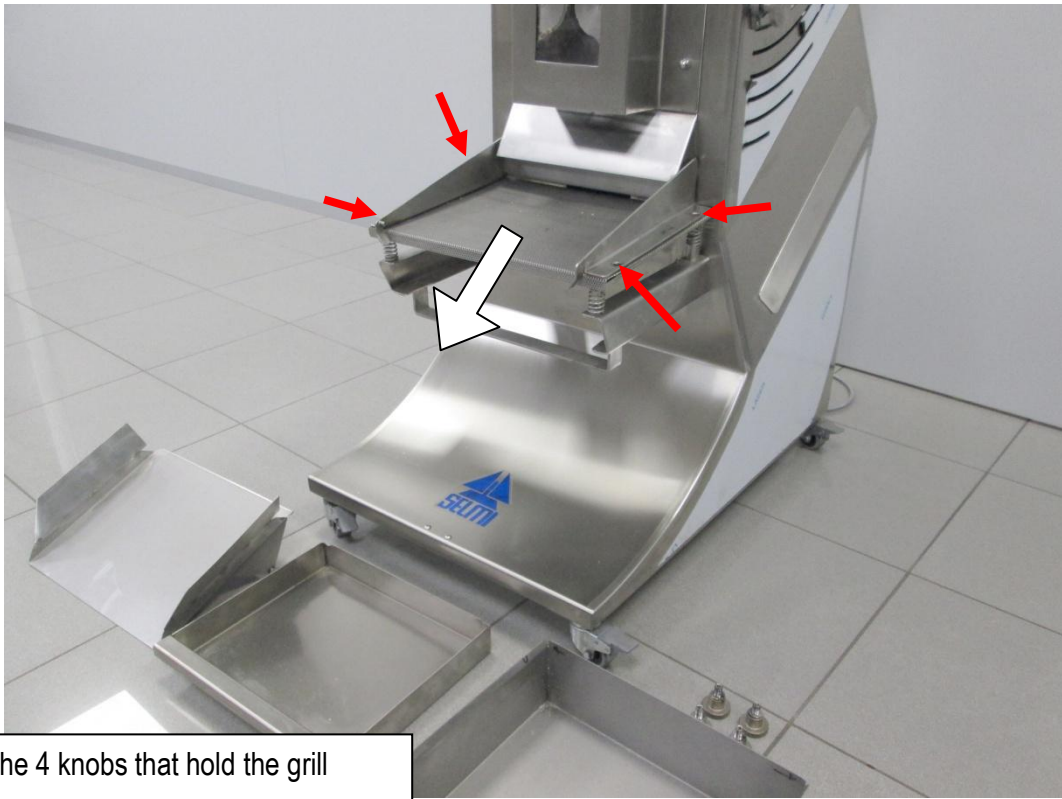

Unscrew the 4 knobs that hold the grill  
Remove the grill  
Clean, wash and dry the grill  
Replace it to the original position





### 7. ELECTRICAL DIAGRAMS

GRINDER

Nome progetto:

Impianto:

Specifiche:

Disegnatore:

Tensione esercizio: 230 V  
 Tensione ausiliari: 24Vac  
 Frequenza: 50 Hz  
 Corrente nominale: 9,5A  
 Potenza totale: 3,5Kw  
 Grado di protezione: IP 55



Rev.	Modifiche	Data	Preparato	Verificato	Approvato

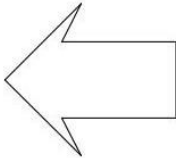
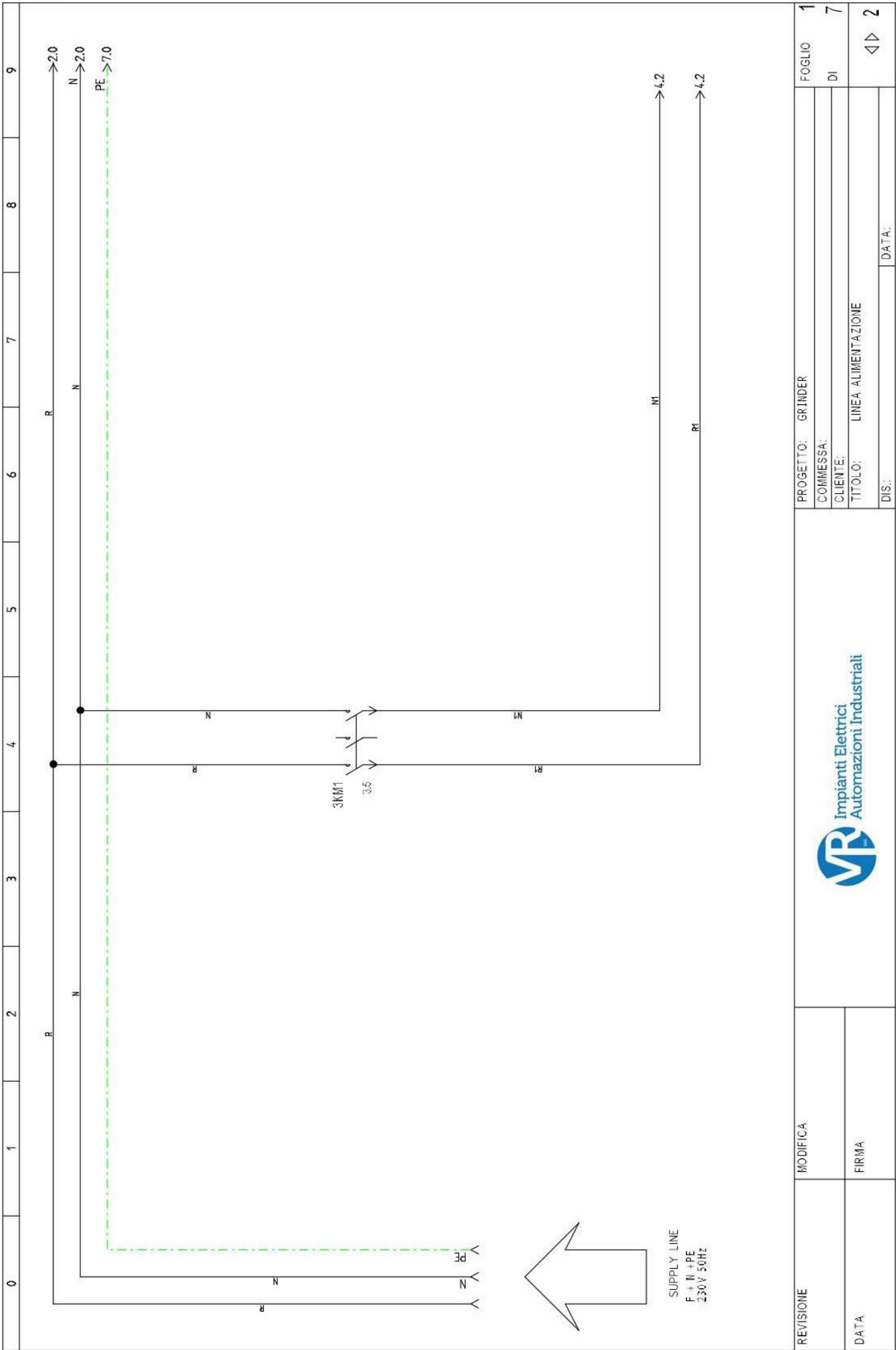

SUPPLY LINE  
F + N + PE  
230V 50Hz



REVISIONE	MODIFICA	PROGETTO: GRINDER	FOGLIO	1
	FIRMA	COMMESSA:	DI	7
DATA		CLIENTE:		
		TITOLO: LINEA ALIMENTAZIONE		
		DIS:	DATA:	2



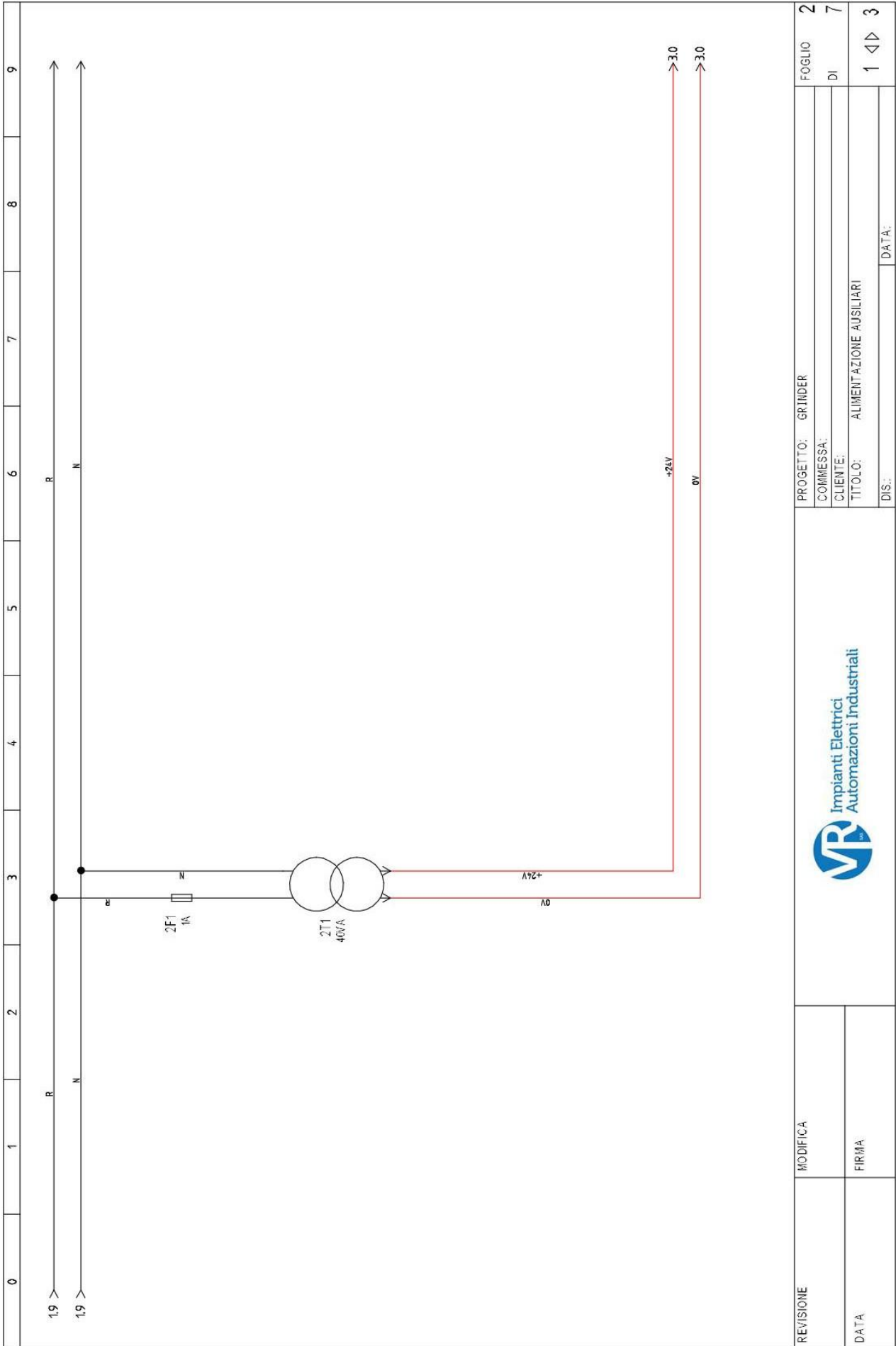

REVISIONE	MODIFICA	PROGETTO: GRINDER	FOGLIO 2
DATA	FIRMA	COMMESSA:	DI 7
		CLIENTE:	
		TITOLO: ALIMENTAZIONE AUSILIARI	1 <> 3
		DIS.:	DATA:



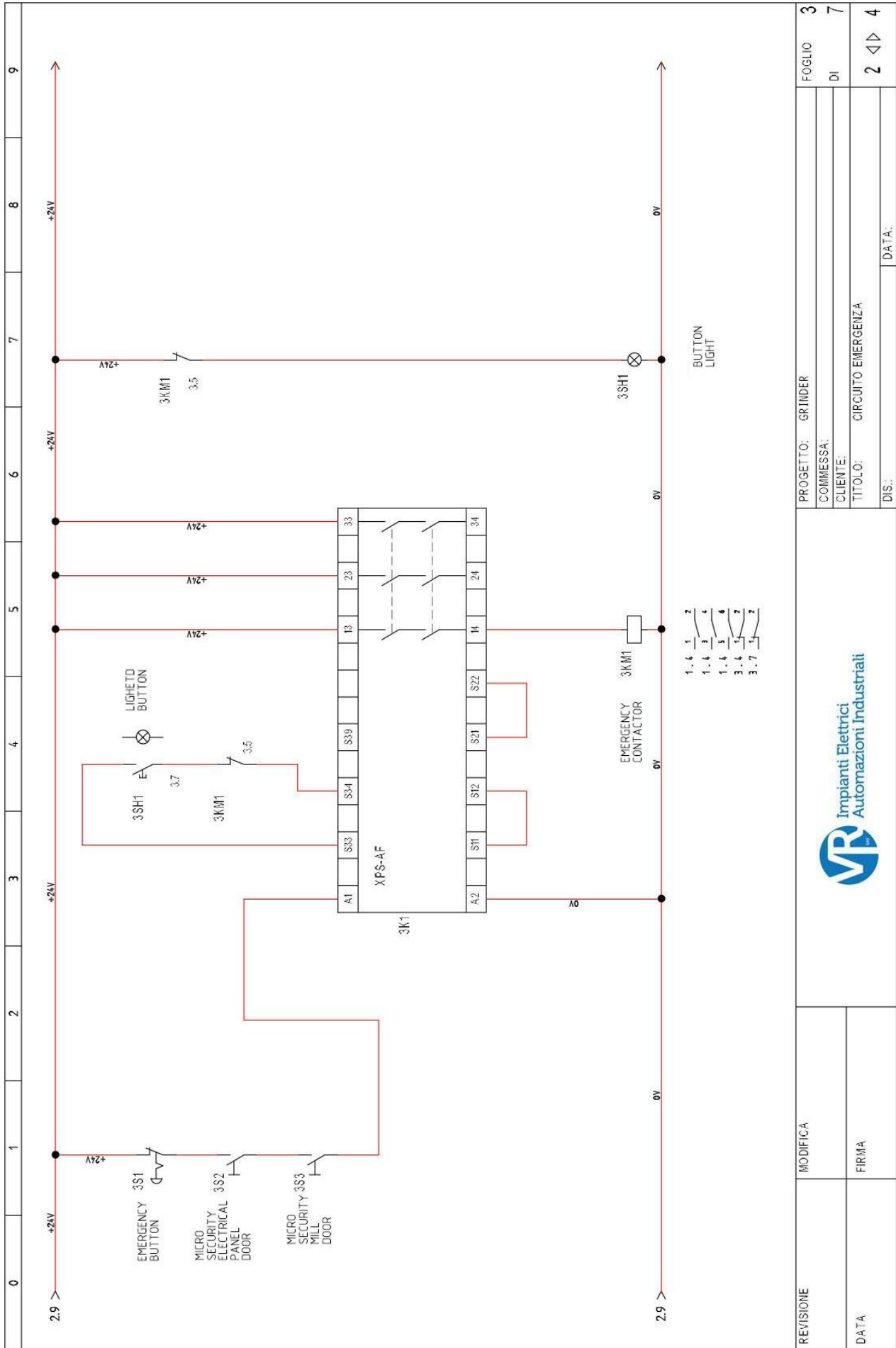

REVISIONE	MODIFICA	 Impianti Elettrici Automazioni Industriali		PROGETTO: GRINDER	FOGLIO 3
DATA	FIRMA			COMMESSA:	DI 7
				TITOLO: CIRCUITO EMERGENZA	2 <D> 4
				DIS.:	DATA:

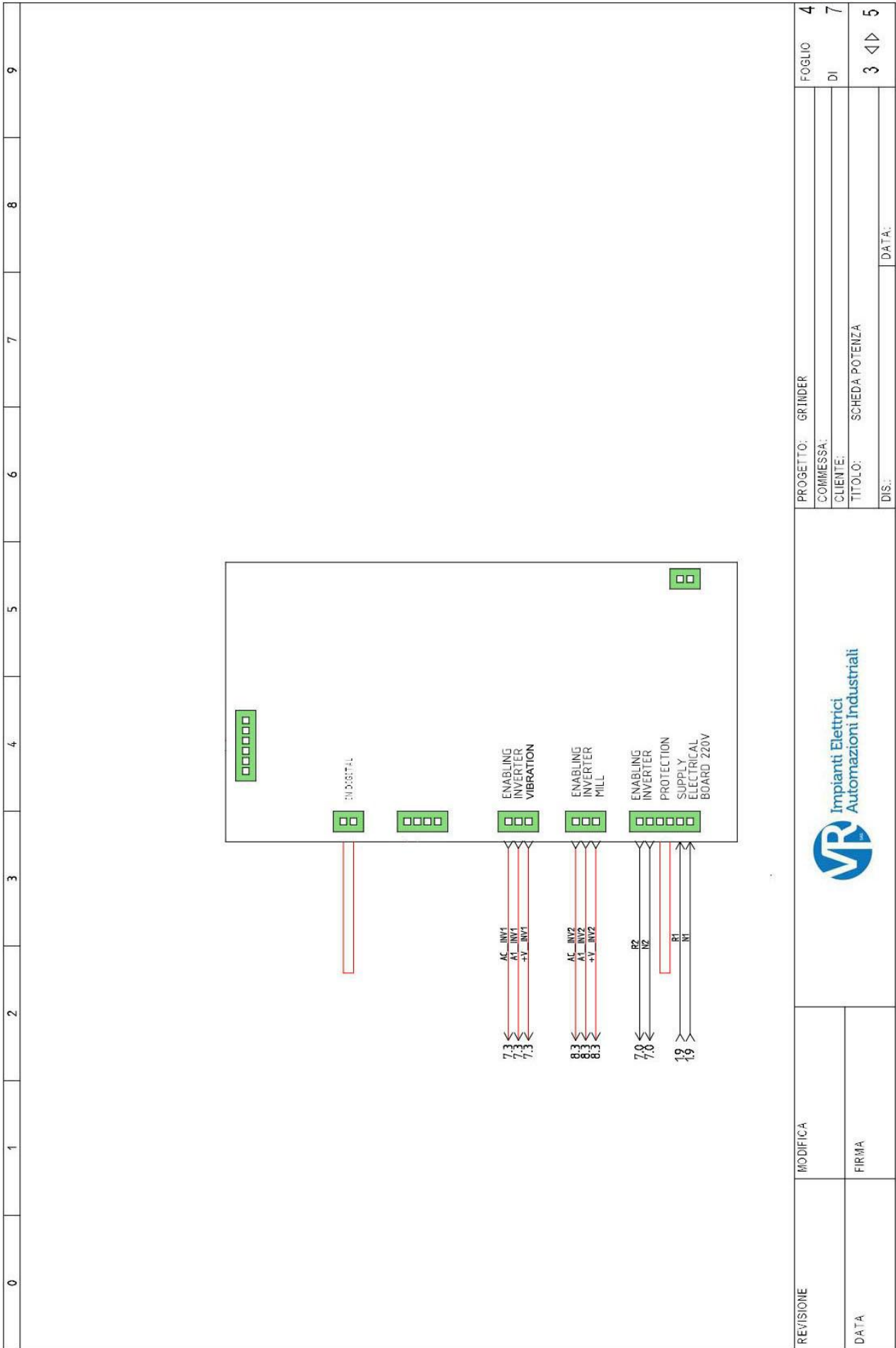



MODIFICA

FIRMA

REVISIONE

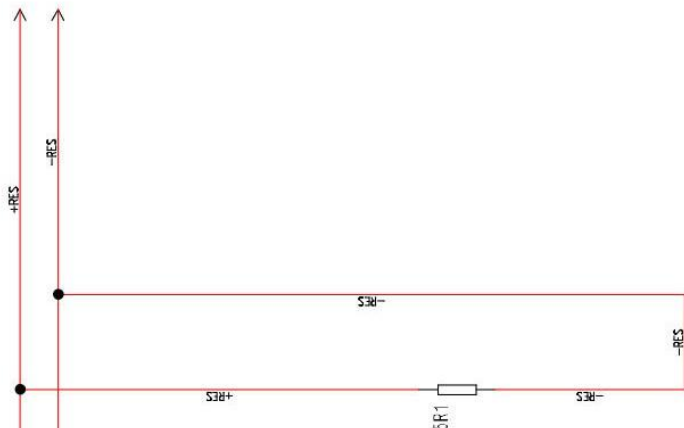
DATA

0	1	2	3	4	5	6	7	8	9
4,4 >	+RES	+RES	+RES	+RES	+RES	+RES	+RES	+RES	+RES
4,4 >	-RES	-RES	-RES	-RES	-RES	-RES	-RES	-RES	-RES
									
REVISIONE	MODIFICA								
DATA	FIRMA								
 Impianti Elettrici Automazioni Industriali									
PROGETTO: GRINDER COMMESSA: CLIENTE: TITOLO: RESISTENZA DIS.: DATA:									
									FOGLIO
									5
									DI
									7
									4 <D>
									7

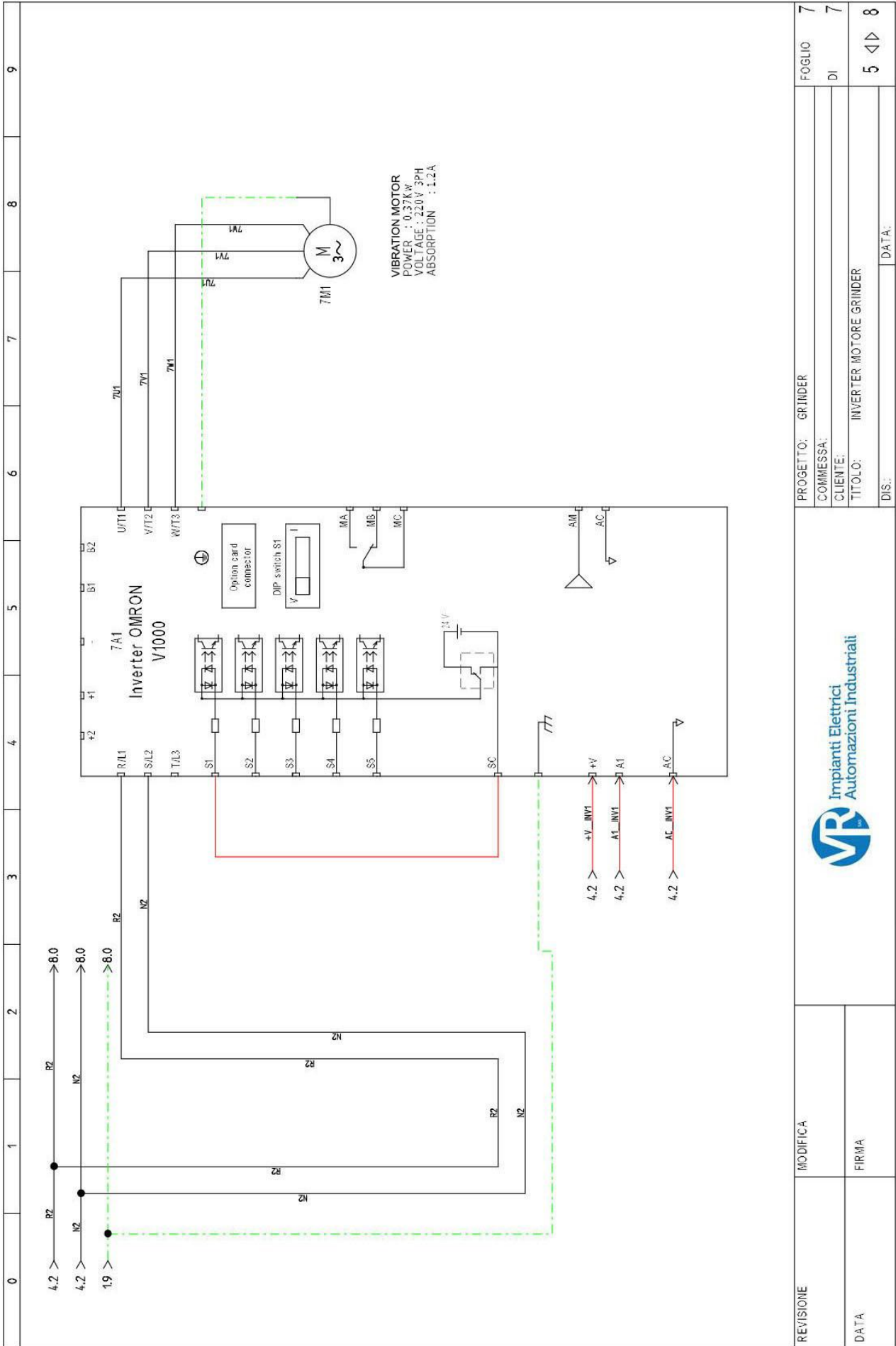



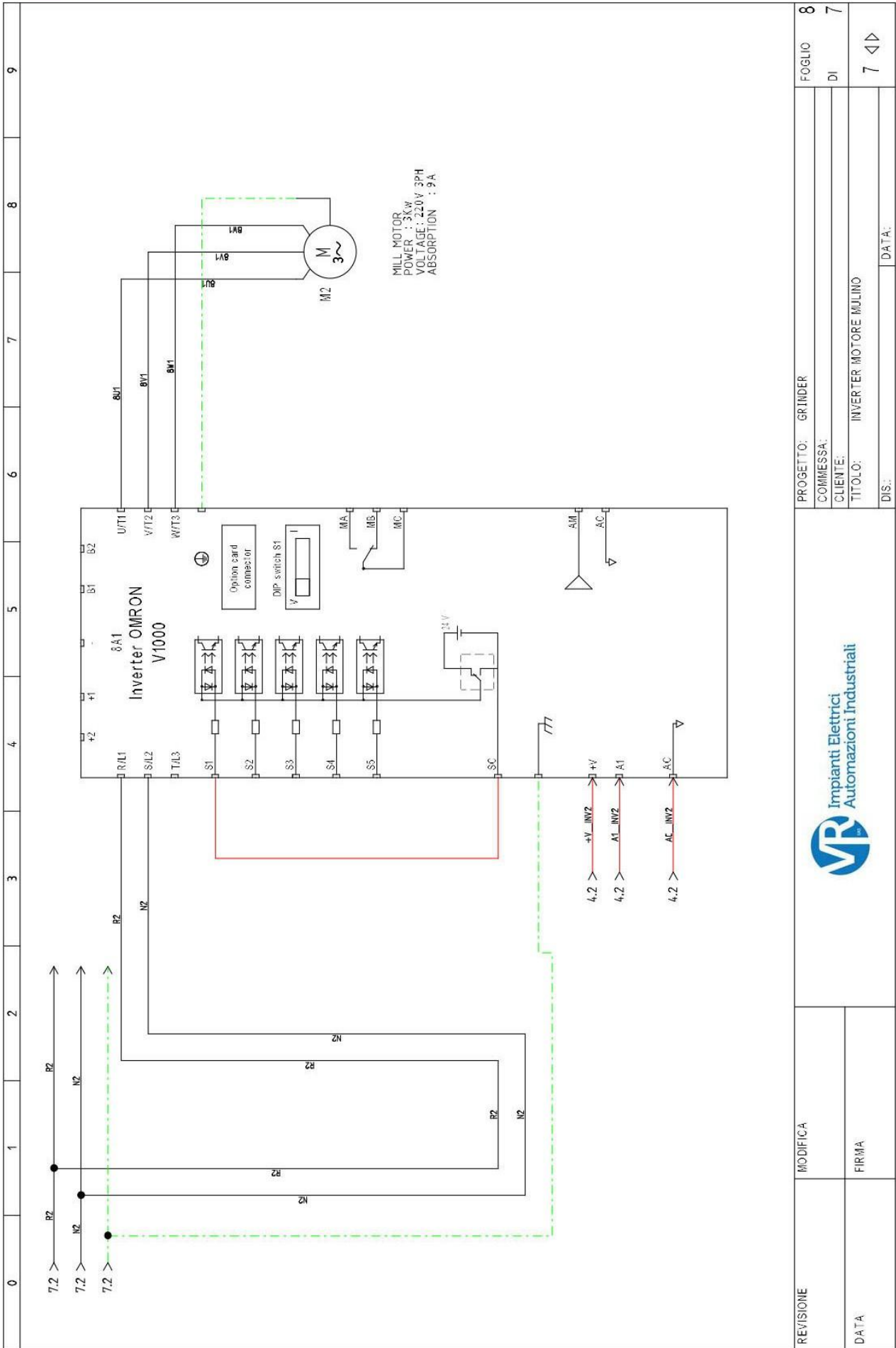









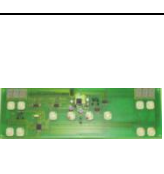

REVISIONE	MODIFICA	 Impianti Elettrici Automazioni Industriali		PROGETTO: GRINDER	FOGLIO	7
DATA	FIRMA			COMMESSA:	DI	7
				CLIENTE:		
				TITOLO: INVERTER MOTORE GRINDER	5 <D>	8
				DIS: DATA:		



REVISIONE	MODIFICA	<p>Impianti Elettrici Automazioni Industriali</p>	PROGETTO: GRINDER	FOGLIO 8
DATA	FIRMA		COMMESSA: CLIENTE: TITOLO: INVERTER MOTORE MULINO DIS: DATA:	DI 7



## SPARE PARTS

	<b>GRI 001</b> Emergency button		<b>GRI 010</b> Skiwelling wheels
	<b>GRI 002</b> Start Reset button		<b>GRI 011</b> Safety micro door electrical panel
	<b>GRI 003</b> Display board		<b>GRI 012</b> Motor mill
	<b>GRI 004</b> Fuse holder		<b>GRI 013</b> Motor grinder
	<b>GRI 005</b> Main contactor		<b>GRI 014</b> Reducer grinder
	<b>GRI 006</b> Safety module		
	<b>GRI 007</b> Transformer 24 V dc		
	<b>GRI 008</b> Inverter crusher		
	<b>GRI 009</b> Inverter mill		