

SELMI ONE

USER AND SERVICE MANUAL



Index

1. General information 2		3. Moving and transportation section	17
1.1. Structure of the manual	2	3.1. General norms	17
1.2. Messages Used	2	3.2. Packaging	17
1.3. Aim and contents	2	3.3. Transportation	18
1.4. Preservation of the manual	2	3.4. Removal of the packaging	18
1.5. External components	3	4. Installation section	19
1.6. Internal components	5	4.1. Positioning	19
1.7. Details of the manufacturer	7	4.2. Electrical connections	19
1.8. Identification plate of the machine	7	4.3. Installation of the machine	20
1.9. Identification plate of the CE marking	7	4.4. Commissioning	20
1.10. Inteded use	7	5. Operation section	21
1.11. Operating environment	7	5.1. Description of the controls	21
1.12. Noise level	7	5.2. Functions of the buttons	22
1.13. Technical characteristics	8	5.3. Using the machine	23
1.14. Dimensions	8	5.4. Position of the user	25
1.15. Storage	9	5.5. Involuntary electrical interruptions	25
1.16. Disposal	9	5.6. End of the working cycle	25
1.17. Warranty	9	5.7 Warning messages	25
1.18. person qualified to operate	10	6. Maintenance section	26
2. Safety section	11	6.1. General information	26
2.1. Safety information	11	6.2. General safety practice	26
2.2. Safety limitations	11	6.3. Cleaning external parts	28
2.3. Safety symbols and plaques	12	6.4. Emptying and cleaning the machine	28
2.4. Safety and protection devices	12	6.5. Maintenance of mechanical parts	31
2.5. Client's safety measures	14	6.6. Maintenance of electrical system	36
2.6. Personal protection equipment	14	6.7. Components subject to wear and tear	37
2.7. Residual risks	15	6.8. Planned preventive maintenance	37
2.8. Applied Directives	16	7. Technical diagrams section	39
2.9. Harmonized technical norms	16	7.1. Electrical circuit diagram	39
		7.2. Cooling system diagram	39
		8. Spare Parts Section	52



1. General information

1.1. Structure of the manual

To simplify the reading and understanding of the information contained in this manual and to make searches quicker, it has been divided into sections, each dedicated to a specific subject.

1.2. Messages used

Attention

This type of message is used to draw the reader's attention to more delicate or particular procedures which, if not carried out correctly, may pose a risk to the safety of the operator and cause damage to parts of the machine.

Warning

This type of message is used to draw the reader's attention to procedures which, if not carried out correctly or at pre-set intervals, may cause damage to the machine or its parts, as well as to the product being processed.

Environment

Messages relating to the environment draw the operator's attention to the rules to be followed to prevent the risk of environmental damages deriving, directly or indirectly, from use of the machine.

Note

These messages highlight instructions, advice and notes that can be particularly helpful during the various uses of the machine.

1.3. Aim and contents

This manual has been drawn up in consideration of the requirements of directive 2006/42/EC and paying particular attention to describing all the procedures necessary to obtain the best working conditions for the machine and its operators, without neglecting product quality:

The aim of this manual is, therefore, to provide the user with all the information necessary for the correct use and maintenance of the machine. Consequently it is absolutely necessary:

- to meticulously follow the instructions given in the manual during every phase of the machine's life, from transportation to demolition;
- for every machine operator to thoroughly read the contents of this manual;
- for the company's safety officer to make sure that all machine operators have clearly understood how the machine works

Attention

In case of doubts on the correct interpretation of the instructions please contact the manufacturer to obtain the necessary clarifications. All those carrying out any kind of operation on the machine must have thoroughly read and understood the contents of this instruction manual.

Warning

If this manual is damaged or lost, please ask the manufacturer or the authorised distributor in the country where the machine is being used for another copy.

1.4. Preservation of the manual

The instruction manual is an integral part of the machine and must be used to train and inform professional figures operating on the machine. Consequently, it is necessary to follow certain simple instructions regarding its preservation, as follows:

- store the manual in areas protected from humidity and heat, so as not to jeopardise the quality or legibility of any part of the publication;
- keep the manual in an easily accessible place known to the machine operators;
- avoid handling the manual with dirty or greasy hands;
- if you think it is necessary to highlight important steps of the manual, use non-permanent systems, to preserve its legibility;
- do not remove, rip or rewrite any parts of the manual for any reason.

1.5. External components

- | | | | |
|---|--------------------------|----|-----------------------------------|
| 1 | Control panel | 9 | Emergency button |
| 2 | Chocolate exit nozzle | 10 | Left protective panel |
| 3 | Lateral protective panel | 11 | Vibrating table auxiliary sockets |
| 4 | Stop flow pedal | 12 | Key lock for electric panel |
| 5 | Swivelling wheels | 13 | Line connection cable |
| 6 | Reservoir cap | 14 | Rear protective plate |
| 7 | Fan grid | | |
| 8 | Reserve cooling liquid | | |

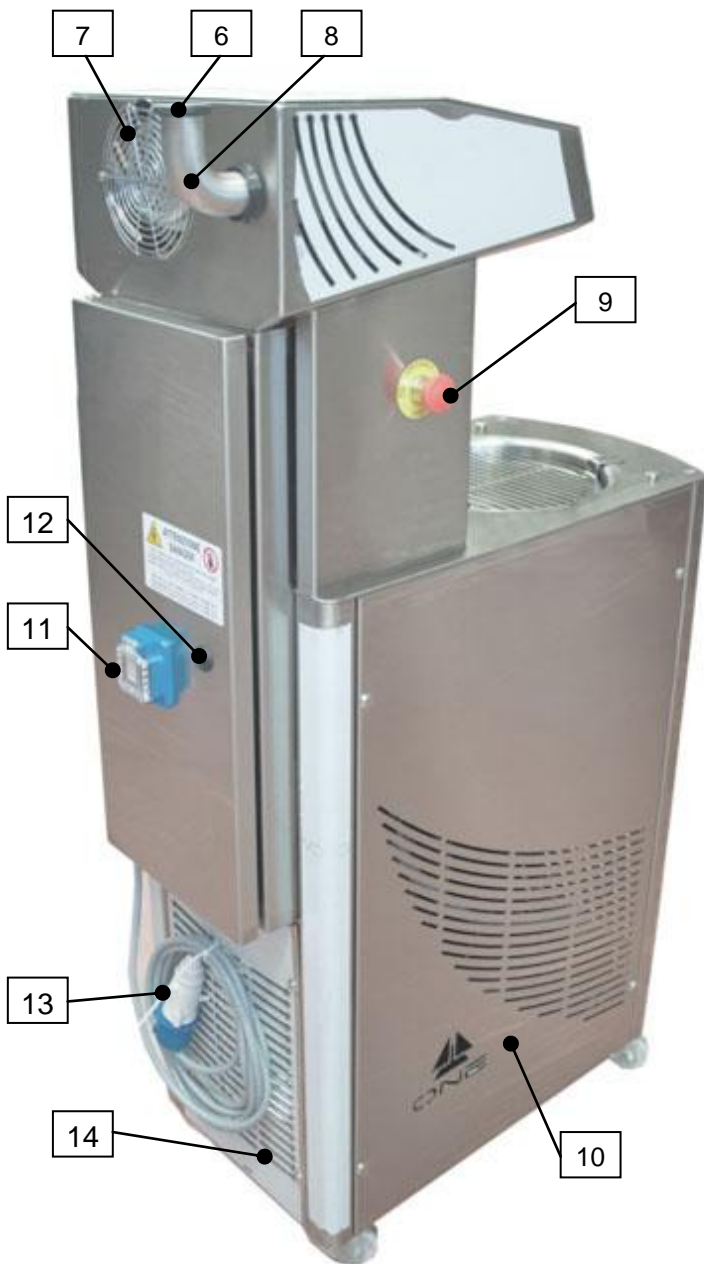

- 15 Tank
- 16 Tank mixer

- 19 Complete vibrating table
- 20 Vibrating motor
- 21 Noise dampening mats

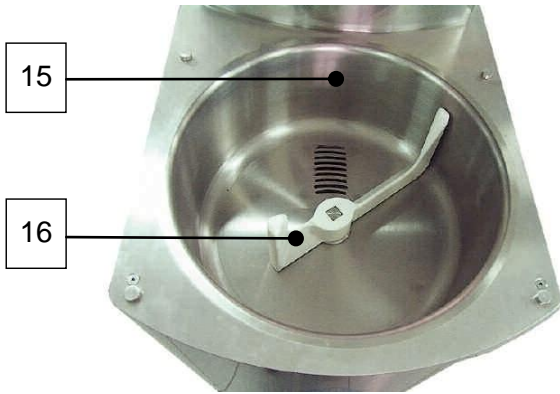

- 17 Protection grill
- 18 Protection grill safety sensor

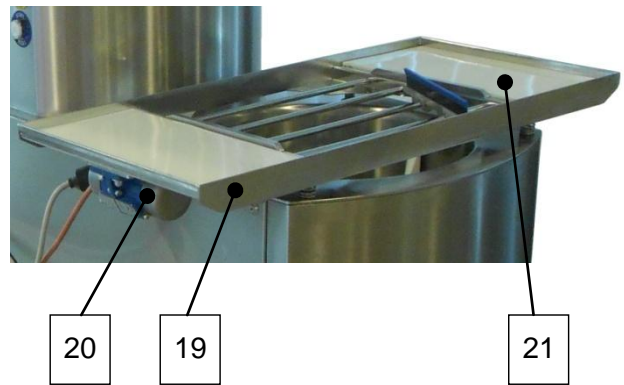

1.6. Internal components

- 1 Display and control card
- 2 Ascension pump motor
- 3 Cooling liquid reservoir
- 4 Ascension pump reducer
- 5 Nozzle
- 6 Nozzle probe
- 7 Cooling bleed valve
- 8 Cooling gas loading point
- 9 Tank motor
- 10 Mixer reducer
- 11 Cooling liquid circulation pump
- 12 Fan and evaporator
- 13 Gas/liquid heat exchanger
- 14 Drainage valve for cooling liquid
- 15 Tank sides band resistance
- 16 Tank-bed resistance
- 17 Tank temperature sensor 1 (side)
- 18 Tank temperature sensor 2 (base)
- 19 Column band resistance
- 20 Product discharge point
- 21 Compressor
- 22 Fridge group solenoid

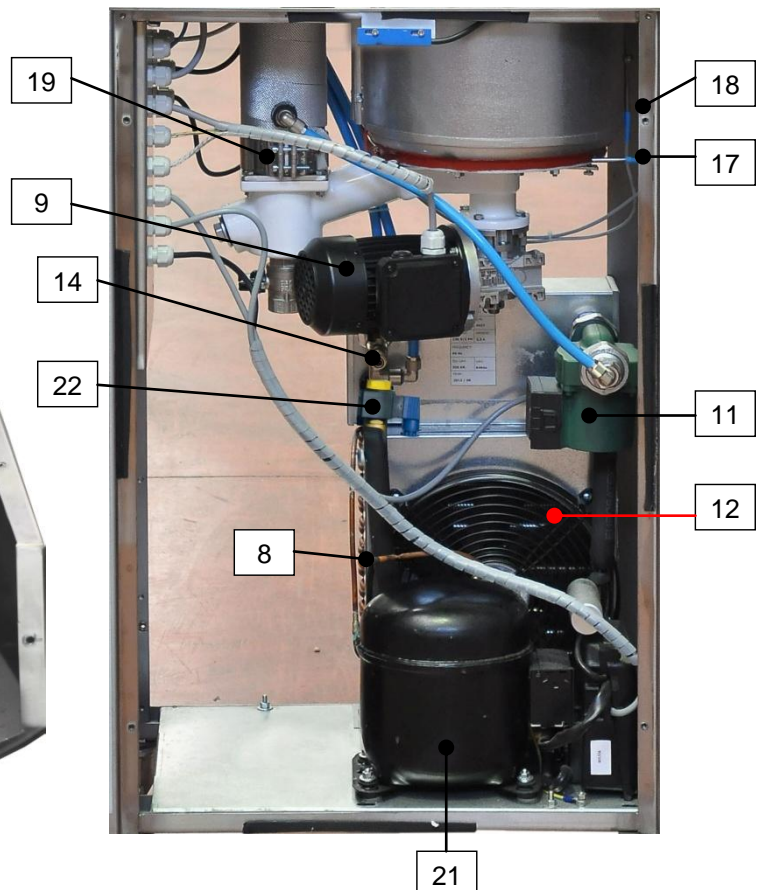
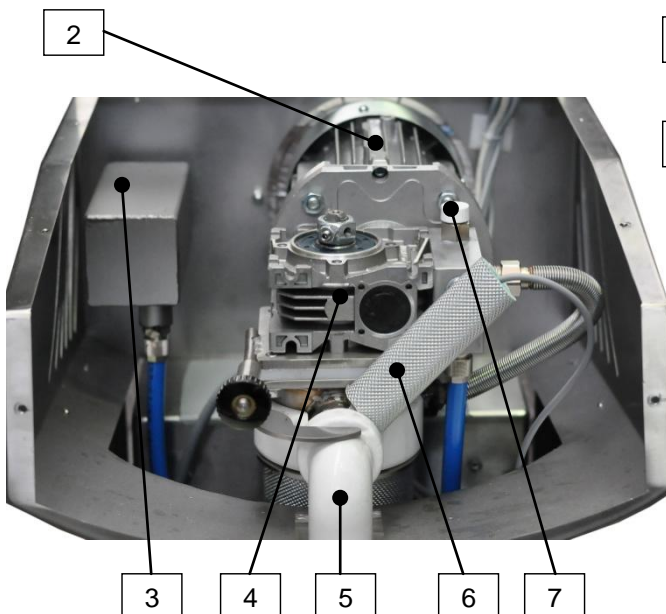
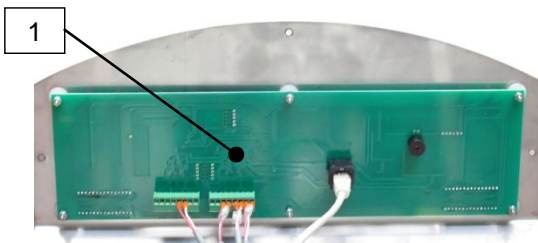
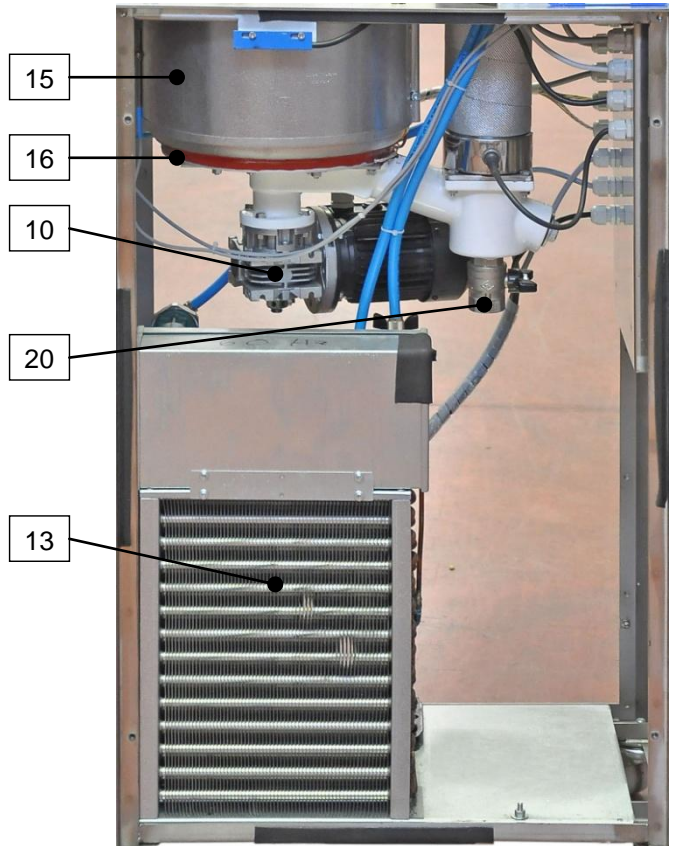

Power board located inside the electric panel

1. Power supply
2. Mixer motor
3. Ascension pump motor
4. Cooler compressor
5. Tank resistance 1
6. Tank resistance 2
7. Cooling liquid pump
8. Column band resistance
9. Auxiliary output 230
10. 24Vac input from transformer
11. Auxiliary output 24V
12. Unipotential circuit ground strap
13. Protection Cover Tank
14. Pedal
15. Control and display cable
16. Transformer 230V – 24V
17. Line contactor
18. Safety module
19. Electrical panel opening limiter
20. 3 protection fuses for the 400V line
21. 1 secondary fuse for 24V transformer (24Vac input on the board).
22. 1 primary fuse for 230V transformer (powering the transformer).
23. 1 fuse for 230V auxiliary components.
24. 1 fuse for 24V auxiliary components.
25. protection fuse for the 400V line

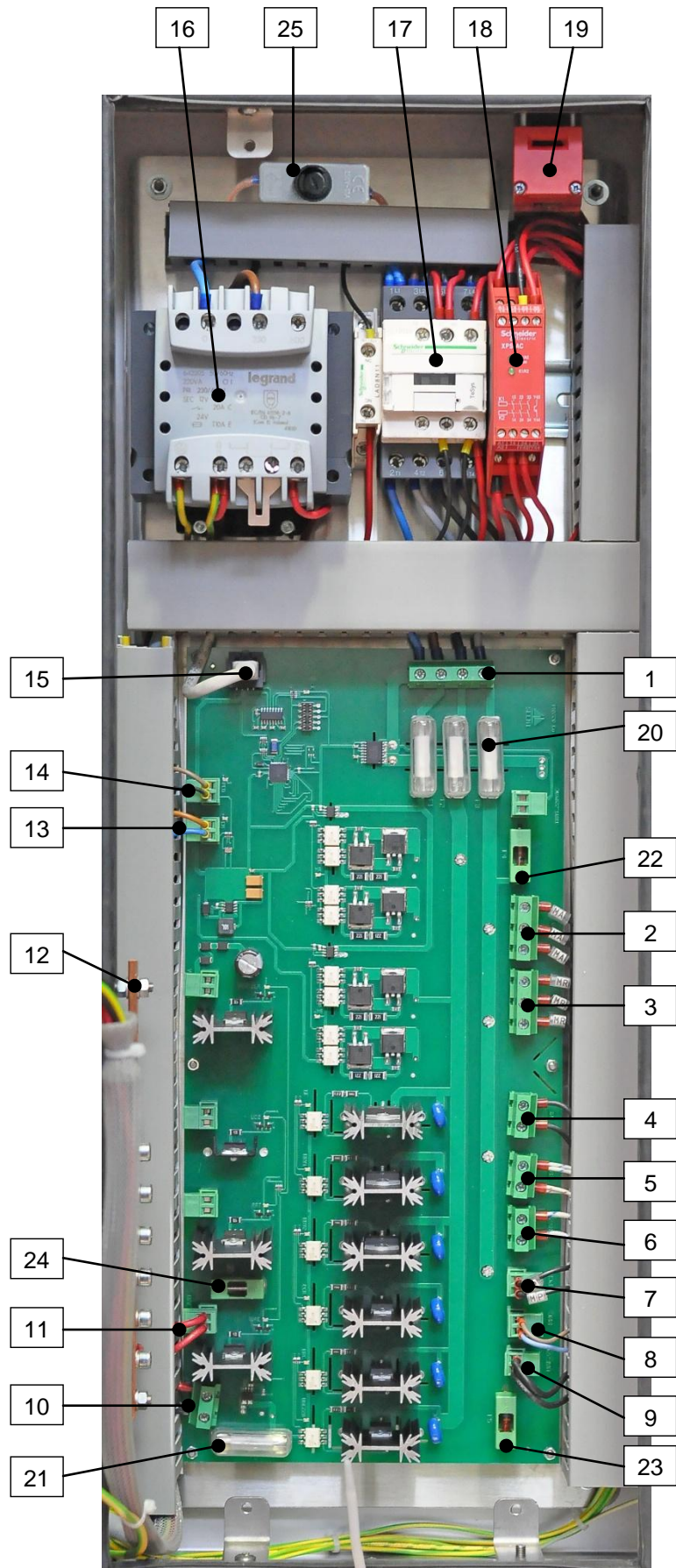



1.7. Details of the manufacturer

The machine described in this instruction manual was built by:

SELMI S.r.l.

Via Statale, 151 – 12069 – S. Vittoria D’Alba (CN) Italia

Tel. 0172.479273 - 0172.479275 - Fax 0172.477814

www.selmi-group.it - info@selmi-group.it

1.8. Identification plate of the machine (CE marketing)

There is a plate, similar to the one shown here, on the machine, indicating details of the manufacturer, the CE conformity mark and the machine’s serial number. Always state this number when communicating with the manufacturer.



Example of identification plate on the machine structure

TYPE
SERIAL NUMBER
YEAR
WEIGHT

1.9. Identification plate of the CE marking electric panel (low voltage)

Example of identification plate on electrical panel. The correct data in the section on the machine’s technical specifications.



1.10. Inteded use

The “ONE” machine is a continuous tempering machine for chocolate complete with vibrating table. It can be used for the following types of product: plain chocolate, milk chocolate and white chocolate, to perform the tempering operations.

The vibrating table supplied with the machine allows performance of the moulding operations.

It is possible to accessorize the machine with further options.

Warning

A use other than that specified is considered improper. The machine is intended for professional use only.

Attention

Do not place any small objects near the control panel or the tank: they could fall and enter the tank, which would contaminate the product.

1.11. Operating environment

To guarantee proper functioning the machine must be protected from atmospheric agents. Its ambient operational temperature should be between 15C° and 35C° with relative humidity not exceeding 70%.

The working environment must be clean, sufficiently illuminated and away from an explosive environment.

The environmental characteristics of the installation site are specified in section 4.

Attention

The machine’s fixed guards have a variety of openings to allow the internal units to cool. When the machine is running, make sure that these openings are not covered by cloths or objects that obstruct proper air flow.

1.12. Noise level

The phonometric tests carried out on this specific machine model show an acoustic pressure lower than 70 dB(A).

1.13. Technical characteristics

Mechanical characteristics

Tank capacity:	12 Kg product
Tank steel:	AISI 304 L
Column steel:	AISI 304 L
Gaskets:	PTFE
Total weight (empty):	150 Kg approx.
Tank reducer ratio:	1:60
Tank mixer speed:	30 rev. per min. approx.
Cooling gas:	R404A
Cooling liquid:	Mix: 80% water 20% glycol without phosphates

Electrical characteristics

Power consumption:	1 kW max
Power supply voltage:	230V or 400V*
Phases:	1 or 3*
Frequency:	50Hz or 60Hz*
Wrapping protection:	IP65

* This data can change according to the contractual installation conditions. For correct data refer to the plate inserted inside the electric panel.

1.14. Dimensions

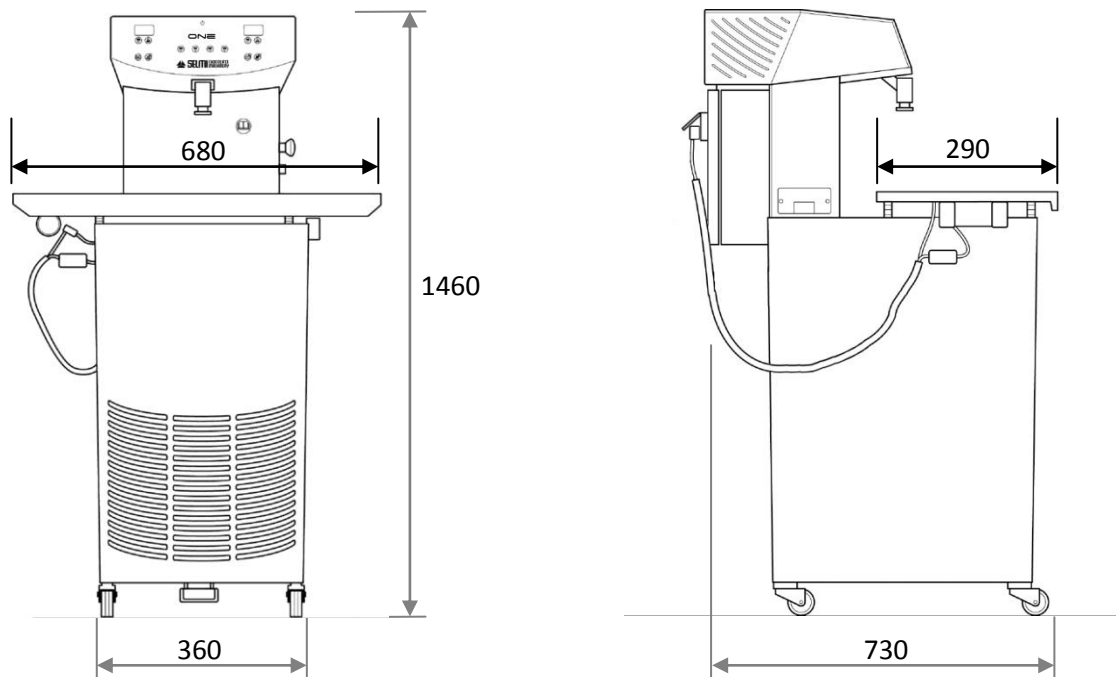



1.15. Storage

Remove the remaining product left in the machine following the instructions in the appropriate section. Stop the machine using the main switch and disconnect it from the electricity main. Move it to a spacious place (it is necessary to work all around the machine).

Clean the tank, the removable components (i.e. screw pump, mixer, nozzle) and the pipes as described in the appropriate section.

Attention

It is absolutely necessary to follow the instructions in order to insure the safety of the operators and to avoid damaging the machine's removable parts.

Use a brush to cover the movable components and the mechanical moving parts with a thin layer of food grade lubricant. This can later be removed with an alkaline de-greaser (Sodium Hydroxide) if the machine needs to be re-installed.

Carry out the same operation on the machine surfaces, taking care of avoiding the heating elements located in the inner part of the machine.

Gather the parts (use as reference the delivery packing list) and put them in the original packaging. Place packets of hygroscopic salt based on silica gel in the packaging.

Store all the parts in a sheltered place away from atmospheric agents and in temperatures from 0° C to 40° C. Cover the parts with nylon in order to prevent the accumulation of dust.

1.16. Disposal

Disposal will occur at the end of the working life of the machine, which under normal conditions of use and maintenance will be over ten years.

In the case of disposal all the components of the machine will have to be disposed of in adequate waste yards according to the legislation in force.

Before disposal it will be necessary to separate the plastic or rubber parts and the electrical and electronic material.

Environment

Parts made solely of plastic, aluminium and steel can be recycled in the appropriate collection centres.

According to the RoHS regulations electronic boards and electric material should be recycled separately in authorised collection centres.

1.17. Warranty

The manufacturer offers a warranty on this machine model for a period of 24 months from the purchase date, as shown on the fiscal document issued at the time the machine is delivered.

The warranty will be void if the machine is repaired by a third non authorized party or if fixtures and accessories not supplied by or recommended or approved by the manufacturer are used.

The warranty will also be void upon removal or alteration of the plate showing the serial number and other data.

Within the warranty period the manufacturer will repair or replace, free of charge, parts that are faulty due to manufacturing.

In case the repair has to take place at the manufacturer's site, the machine will have to be sent to the manufacturer in its original packaging.

Transportation expenses will be covered by the manufacturer during the warranty period.

The warranty does not cover the cleaning of the functioning parts.

Defects not clearly attributed to the material or the manufacturing will be examined. If the claim should turn out to be unjustified all repair expenses, changed parts and transportation will be charged to the buyer.

The warranty does not cover damage caused by the following:

- accidental damage during transportation
- damage due to lack of care or procedures carried out incorrectly
- damage due to improper use not conforming to the warnings of the user and service manual
- components subject to wear and tear; a detailed list is available in the components section.

Structural damage, modifications, improper alterations or repairs can affect the functioning of the safety mechanisms, thus making the declaration of conformity and warranty void. Alterations on the machine can be carried out solely by technicians authorised by the manufacturer.

1.18. Professional personnel qualified to operate the machine

The machine must only be used by authorised and purposely trained personnel; the same precautions are also applicable to personnel who carry out maintenance.

Personnel who do routine and extraordinary maintenance must be specially trained professionals; good knowledge of the machine is needed for extraordinary maintenance.

Attention

Do not permit others to approach the machine during its use or maintenance.

The following professional people, after having received all the necessary instructions, are the only ones allowed access to the machine:

Safety officer

The safety officer is responsible for protection and prevention of risks in the workplace, as is mentioned in European Directive 89/391/EEC (Safety in the workplace), introduced in Italy with the 12/11/1994 Legislative Decree.

It is the responsibility of the safety officer to make sure that all personnel who use/maintain the machine have received all the instructions regarding their relative roles contained in this manual.

Operator (user of the machine)

Operator trained and qualified for the use of the machine (working cycle, potential adjustments, etc.).

He/she can only carry out the specific tasks described in this manual reserved for this role.

Mechanical maintenance technician

The technician is qualified to use the machine as the OPERATOR and furthermore to use it with the protection disabled, to attend to the mechanical parts for adjustments, maintenance and reparations.

He/she is not qualified to act on live electrical installations.

The mechanical maintenance technician must have a generic knowledge of the machine and a specific knowledge on this machine model.

Electrical maintenance technician

The technician is qualified to use the machine as the OPERATOR and furthermore to use it with the protection disabled, to attend to the adjustments and electrical installations for the purposes of maintenance and repair.

If qualified, he/she may work when the electrical panels, control devices, are live, provided he/she uses appropriate personal protective devices.

The electrical maintenance technician must have a generic understanding of the electrical panels and specific knowledge on the electrical panel and components of this machine.

Manufacturer

The manufacturer's personnel are qualified to perform all of the above-described operations.

Any operations not described in this manual may be performed ONLY by personnel authorized by the manufacturer.

2. Safety section

2.1. Safety information

Attention

The safety officer has the obligation to inform the workers on the risks related to the use of the machine.

Furthermore the employer must inform, educate and train the user according to statutory laws.

The lack of compliance with the basic norms or precautions could result in accidents during the functioning, maintenance or reparations of the machine. Accidents can often be avoided by acknowledging potential hazardous situations before they materialise. The operator must pay attention to the potential dangers and have the training, the competence and the necessary equipment to deal with these tasks correctly.

The manufacturer cannot be held responsible for accidents or damages resulting from the use of the machine by personnel not adequately trained or having used the machine improperly, as well as the lack of, even partial, compliance to the safety norms and interventions procedures contained in this manual.

The safety precautions and the warnings messages, the operator could be subject to accidents with serious consequences for himself and for other people.

In cases where tools, procedures, work methods or working techniques not explicitly suggested by the manufacturer are used, it will be necessary to make sure that no dangers are present for the individual carrying them out and to other alike.



Use exclusively original SELMI spare parts. The manufacturer will take no responsibility for accidents or damages in the case of use of non-original spare parts.

If a tool not supplied by the manufacturer is installed on the machine, the client needs to make sure that the norms stated in Directive 2006/42/EC are adhered to. If this new tool introduces new risks to the system then the new system must be re-certified. In any case the manufacturer cannot be held responsible for accidents or damages caused by the machine if it has been modified or equipped with non original accessories.

2.2. Safety limitations

Attention

The indications mentioned hereafter cannot completely safeguard from all dangers that one might encounter while using the machine; they must be used in conjunction with common sense and the experience of the operator, the only indispensable measures for the prevention of injury.

Every section has a list of specific safety measures for different operations. The safety measures mentioned here below are generic and should be followed for all procedures on the machine.

The responsibilities assigned to specific people concerning the use of the machine must be clearly defined as stated in the "Qualified Personnel" section.

Attention

The use of the machine is forbidden to personnel who have not been authorised or trained by the safety officer.

Consult the manufacturer before carrying out procedures that are not mentioned in this manual.

Prolonged overloads or anomalies can cause the electric motors and electrical appliances to overheat with resultant harmful fumes. In such cases immediately disconnect the machine from the mains and do not approach the machine until such fumes have been dispersed via adequate ventilation. In case of fires do not use water jets on the machine – use CO2 extinguishers instead.

The operator, any helping technician and the maintenance technician must use the appropriate personal protection equipment when working on the machine.

It is forbidden to climb on the machine.

Do not touch the electrical wires, switches, buttons etc. with wet hands.

The parts subject to wear and tear during the functioning of the machine must be checked and replaced as soon as they present noticeable signs of wear and tear.

The manufacturer has designed and built the machine to last for a reasonable time with the Client's normal conditions of use in mind; it is however necessary to periodically check the components and the structure of the machine, paying attention to any anomalous conditions, such as, for example, cracks or deformations. If necessary, contact the manufacturer to ask for a complete check of the machine.

Please consult Section 4 (Installation) for the working environmental conditions of the machine.

2.3. Safety symbols and plaques

The machine has a number of plaques with symbols and/or safety messages stuck to it.

Attention

Make sure that all the safety messages are legible and in good condition.

Replace the damaged plaques with the new ones from the manufacturer. If a plaque happens to be on a part that is being replaced, make sure that a plaque is present on the new piece. For the cleaning of the plaques consult the appropriate section (6.3).

ATTENTION

THE PERFORMANCE OF WORK ON ELECTRICAL EQUIPMENT CONNECTED TO THE POWER SUPPLY IS STRICTLY FORBIDDEN

- ANY EXCEPTIONS MUST BE AUTHORISED BY THE EXECUTIVE MANAGER
- IN PARTICULARLY DANGEROUS SITUATIONS, ANOTHER PERSON MUST BE PRESENT IN ADDITION TO THE PERSON PERFORMING THE WORK

WORK MAY ONLY BEGIN WHEN THE SAFETY MEASURES HAVE BEEN IMPLEMENTED

IN OBSERVANCE OF PRESIDENTIAL DECREE 543 ON THE PREVENTION OF ACCIDENTS



(positioned on the door of the electrical panel)



Label indicating compulsory reading of the manual
(positioned on the front of the machine)

2.4. Safety and protection devices

Attention

The components shown here are particularly important for the safety of the operator and the machine. In cases of malfunction or wear they must be replaced with spare parts supplied or authorized by the manufacturer.

While the machine is in use all the protection devices must be correctly installed.

The safety devices present on the machine are:

- Mushroom emergency button with mechanical unblock mechanism.

There is an emergency stop mushroom button on the machine. Pushing it cuts voltage to all live parts by means of appropriate devices. To reset it, release the emergency button by turning its head and then push the RESET button shown in the photo.

Before starting every shift, press it to make sure that it works .





- Electric panel safety microswitch

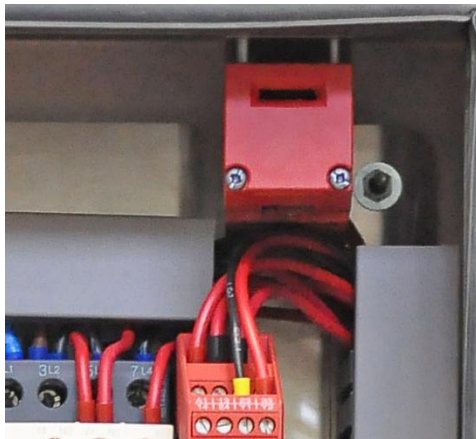

Within the electrical panel there is a safety microswitch which disconnects the voltage every time the panel is opened for maintenance interventions.

Attention

Periodically check that the safety microswitch is working properly. If faulty, please proceed immediately with its replacement.

Fuses

The following fuses are located within the electric panel on the power board:

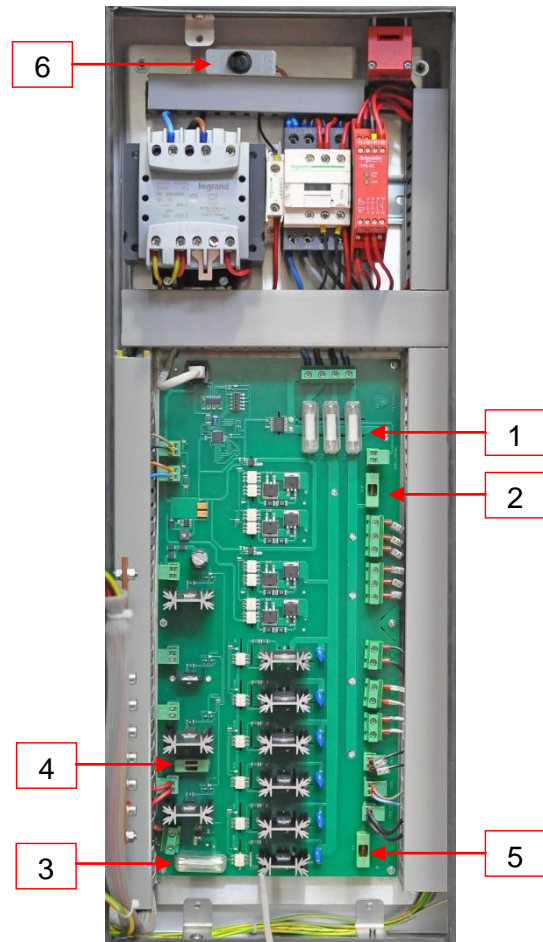

1. 3 protection fuses for the 400V line
2. 1 primary fuse for 230V transformer
3. 1 fuse for 24V transformer (24Vac input on the board).
4. 1 fuse for 24V auxiliary components.
5. 1 fuse for 230V auxiliary components.
6. 1 protection fuse for the 230V line

To change the fuses see section 6.6.2

Warning

If fuses keep blowing it may be an indication of a fault of the devices installed on the machine; in such cases contact Technical Support.

- *Protective devices*

The machine is equipped with protective plates (Pg. 2 points 9, 10 and 16) that can be removed with a tool to allow access to the inside of the machine in order to carry out maintenance operations.

The fixed protective plates are screwed into position and can be removed with the appropriate tool; if the screws are removed the fixed protective plates will not remain in place and must be placed on the floor.

All the protective plates have smoothed and rounded edges for the safety of the exposed individual and of the operators.

The protective plates have loss-proof screws that remain attached to the plate when it is removed from the machine.

To remove the protective plates see section 6.5.

Attention

Do not switch the machine on if the protective panels are removed or not correctly fixed into position with the appropriate screws.

Do not forget to remove cloths, keys or utensils used for the maintenance operation from within the machine.

Before closing with the protective panels and switching on the machine check carefully and if necessary remove any extraneous objects which may be present inside the machine.

All protection and safety devices must always be kept in perfect working conditions. If faulty, they must be immediately repaired or replaced.

The replacement, disengagement, partial or total removal of the protective plates, safety devices and protective structures must only be carried out during maintenance operations. This also applies to the safety plaques attached to the side of the machine.

2.5. Client's safety measures

The client must arrange for the following safety measures to be in place:

Provision of an adequate location for installation, paying particular attention to the characteristics below:

- Adequate flooring
- Normal and emergency lighting
- Adequate ventilation
- Clearly signposted emergency exits
- Provision of mains voltage connection with associated safety devices, conforming with the norms in force and the characteristics of the machine
- Adequate means for the collection and subsequent disposal of residues, even hazardous or special ones (oils and grease, broken or waste material, etc.).
- Adequate fire safety systems and equipment
- Prohibition of entry into the installation area to non authorized personnel

The customer must also provide for:

- Training of the operators and the maintenance technicians
- Training for the operators on the basic functioning of the machine and emergency devices
- Provision of personal safety equipment to protect the operator and the hygiene of the product
- Checking the qualifications of external maintenance technicians potentially called to work on the machine
- Keeping of a maintenance log book

The employer is also responsible for checking that the operators correctly carry out the procedures explained in this manual.

2.6. Personal protection equipment

The operators who carry out functions on the machine must receive appropriate instructions on the use of personal protection equipment such as shoes, gloves, etc... which will protect them from residual risks derived from the execution of various activities. The operators must furthermore be equipped with protection equipment for hygiene purposes (caps or hair nets, gown, etc...).

If the noise level in the working environment surpasses 85dB(A) appropriate ear protection must be used.



Warning

The clothing of whoever operates or carries out maintenance on the machine must conform to the essential safety requirements defined by European directive and the laws in force in the country in which the machine is installed.

Attention

During maintenance operations individuals must wear adequate clothing to prevent the occurrence of accidents.

In order to avoid mechanical risks such as snagging or dragging, it is prohibited to wear particular objects such as bracelets, watches, rings or necklaces during the working cycle and during maintenance operations.

2.7. Residual risks

The accurate risk analysis carried out by the manufacturer and archived in the technical file has eliminated most of the residual risks, which are nevertheless present during the use of the machine, to acceptable levels.

The manufacturer's recommendation is to meticulously adhere to the instructions, procedures and recommendations contained in this manual.

Attention

It is strictly prohibited to carry out any type of mechanical or electrical modification so as not to create added dangers and unforeseen risks.

Attention

During cleaning and maintenance operations and during the work cycle, do not allow the product inside the tank to come into contact with water or other fluids.

Attention

If the machine remains unused for long periods of time please take note of the expiry date of the product remaining inside the machine. Upon restarting the processing only insert new chocolate if the product already in the machine has not expired. If the old product has expired, proceed to empty and clean the machine before inserting the new product.

Attention

Keep the machine with the residual chocolate inside the tank in an adequate environment with temperatures ranging from 10 °C to 25 °C.

The residual risks present on the machine are:

Risks during machine transportation

It is recommended to fasten the machine, or its parts, at the dedicated locations and lift it with appropriate means to the minimum permitted height, proceed at low speeds and make sure that the people helping with the moving are at a safe distance from the moving object. Before moving the machine make sure that the passage is clear and that there are no objects placed on the machine. It is important that the means of support and transportation is controlled by a person qualified for such a role, so as to avoid unforeseen movements which may be dangerous to the people in the vicinity who are helping with the moving.

Risks of faults to the circuits of signalling, safety, protection and emergency stop

In the case of a circuit fault, the safety and signaling circuits, the anti-injury protections and the emergency stop can lose their effectiveness, therefore it is asked that their functionality is periodically checked.

Identified residual risks and information plaques

The manufacturer has placed on the machine danger and/or warning plaques, based on the residual risks, with pictograms in compliance with the norm pertaining to the display of graphic symbols on the machine.

The user should immediately replace these plaques if they are not clearly legible.

Attention

It is expressly forbidden to remove the safety and/or warning plaques placed on the machine. The manufacturer will not take any responsibility on the safety of the machines if this is not observed.

Risk to life (electrocution)

Before commencing work on any electrical appliance it is necessary to disconnect the machine from the mains. If it were to become necessary to work within the electric panel by bypassing the electricity cut off devices, then the work must be carried out exclusively by specialised personnel.

Risk of spreading fire

In case of fire never use jets of water in the vicinity of the apparatus. Disconnect all connections to the mains and use the appropriate CO2 extinguishers located in the building.

2.8. Applied Directives

The following directives apply to the machine described in this manual:

- 2006/42/EC machinery Directive
- 2014/30/UE Directive for electromagnetic compatibility
- 2014/35/UE low voltage Directive

And the regulation:

- 1935/2004 EC regulation for materials in contact with foodstuffs

2.9. Harmonized technical norms

The machine was designed and tested to conform to the "essential requirements to health and safety" present in attachment I of European Directive 2006/42/EC.

The norms used as reference for the design, the realization and the testing of the machine are listed in the technical file archived by the manufacturer.



3. Moving and transportation section

3.1. General norms

Before moving the machine always check the weight and general instructions shown on the packaging. Personnel not responsible for the movement of the machine must not remain in the area needed for movement.

3.2. Packaging

The machine is delivered on a platform, secured by means of straps and placed inside a cardboard packaging which is also secured to the platform by means of straps. An example of the machine packaging is shown in the picture below.



Instructions for transportation are on the sides of the packaging.

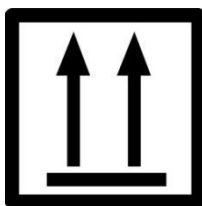

The first symbol shows the correct upright position of the packaging;



the second symbol shows that the packaging must be protected from the rain;



the third symbol shows that the content of the packaging is fragile and must be handled with care. On two sides of the packaging there is a device called "TILTWATCH", which can determine if the packaging has been tilted to such an extent that the content may have been damaged; it is necessary to pay attention to the instructions given on the adhesive label. If the machine has been excessively tilted during transportation (the dot at the centre of the TILTWATCH device will be red) some components could have been damaged.



Attention

The manufacturer's warranty does not cover damage during transportation; the buyer should follow the instructions on the adhesive label in order to avoid disputes.

3.3. Transportation

To transport the machine it is necessary to use a suitable vehicle equipped with a platform to lift the load; the platform must be adequate for the weight of the machine, which is stated in the technical characteristics section (section 1.13).

When the machine, still in its packaging, is in the body of the lorry, it can be carried to the lifting platform only by means of a manual transportation trolley for euro pallets.

The lifting platform has to be equipped with side rails in order to prevent the machine from falling when it is still high off the ground.

The machine can be lowered to the ground from the platform only after having lowered the manual trolley.

The machine should be lowered slowly from the platform, avoiding shaking and sudden stops which could cause a loss of stability.

After having completed the unloading procedures, the machine should be moved exclusively by means of a manual transportation trolley adequate for euro pallets; the platform should only be lifted to the height needed to move the machine.

Before moving the machine verify that the passage to the final destination is clear.

Attention

Do not go on very steep ramps which could cause the loss of control of the trolley.

3.4. Removal of the packaging

Cut the straps that anchor the cardboard to the platform; remove the cardboard and put it out of the way.

Cut the straps that hold the machine to the platform, remove the machine's plastic cover and unravel the accessories provided.

Carefully lift the front of the machine and remove the wooden slat blocking the front wheels; subsequently remove also the wooden slat blocking the rear wheels by lifting the back of the machine.

Very carefully lower the machine from the platform.

Note

Keep the original packaging; it may be necessary to use it if the machine needs to be sent to the manufacturer for extraordinary maintenance or repairs.



4. Installation section

4.1. Positioning

Warning

Before positioning the machine check that the machine, the associated accessories and the parts supplied separately have not been damaged during transportation.

It is the task of the Client to make sure that the strength of the supporting surface, at the point of installation, is adequate for the weight of the machine.

The flooring at the point of installation must be sufficiently level.

Isolate the machine from any potential vibrations coming from other nearby machinery.

In the case where the machine or any of the associated accessories are found damaged it is important to alert the manufacturer of the found anomaly so as to agree on the actions to be taken.

Attention

The machine must be placed on a level surface; for the other environmental requirements necessary for optimal functioning of the machine please see sections 1.11 and 2.5..

4.2. Electrical connections

Attention

The connection of the machine to the electrical system must be carried out by personnel observing the legislation in force; the characteristics of the electrical connection must be compatible with the electrical specifications of the machine which can be found in the relevant section or on the opposite plaque on the door of the electric panel.

Attention

If the machine has been purchased to be powered by a three phase line, make sure that in the socket there is a connection to the neutral wire. This is necessary for the functioning of the machine.

Attention

Before starting any procedure make sure that there are no objects inside the tank.

When connecting the machine to the electrical system via a three phase line, check the direction of rotation as follows:

- 1) plug in the machine
- 2) verify that the emergency stop button is not pressed and, if this is the case, reset it
- 3) put the protection grill on the tank (see section 4.3)
- 4) press the reset button, the machine stand-by light will go on (section 5,1, lamp D)
- 5) press the "prewarm" button (section 5.1, button B)
- 6) press the "restore functions" button (section 5.1, button I); the machine will produce an acoustic signal
- 7) press the "mixer command" button (section 5.1, button C); the blade in the tank (mixer) will start to rotate

Warning

The machine can work only if the tank mixer is rotating anticlockwise when observed from above.

If the rotation direction is wrong, it is necessary to act as follows:

- 1) press the "mixer command" button (section 5.1, button C); the blade in the tank (mixer) will stop moving
- 2) switch off feeds to the machine by pushing the emergency button
- 3) disconnect the plug, open it and swap the position of the two black wires (see the following picture), paying attention not to disconnect the other wires

Nero: Black

Blu: Blue

Giallo/Verde: Yellow/Green

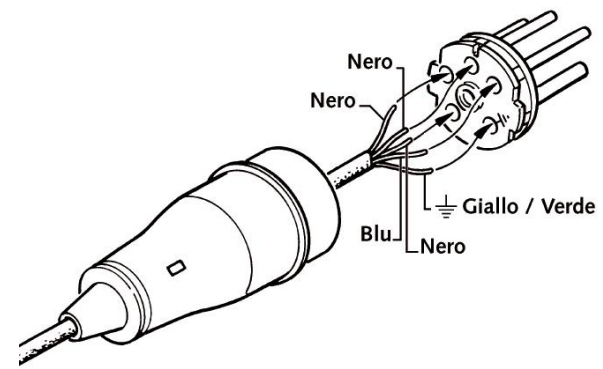

Attention

This operation should be carried out by a technician or by a maintenance electrician.

If the mixer is rotating in the correct direction carry out the following steps:

- 1) press the “mixer command” button (section 5.1, button C); the blade in the tank (mixer) will stop moving
- 2) press the “restore functions” button (section 5.1, button I); the machine will produce an acoustic signal
- 3) turn off the machine by pressing the emergency button

When the testing of the rotation direction is completed, the installation procedure can be continued as described in the following sections.

4.3. Installation of the machine

After positioning the machine and connecting it to the electrical supply, do as follows:

- Clean the supplied accessories (see section 6)
- Install the protection grill on the tank

Attention

Make sure that no objects used during installation have been left in the tank; if so, remove them.

- To carry out this operation it is necessary to correctly attach the grill side fastener to joint shown by the arrow A (see picture below)



- Positioning of the vibrating table

To carry out this procedure it is necessary to align the vibrating plate support springs (B) with the pivots on the machine (C).

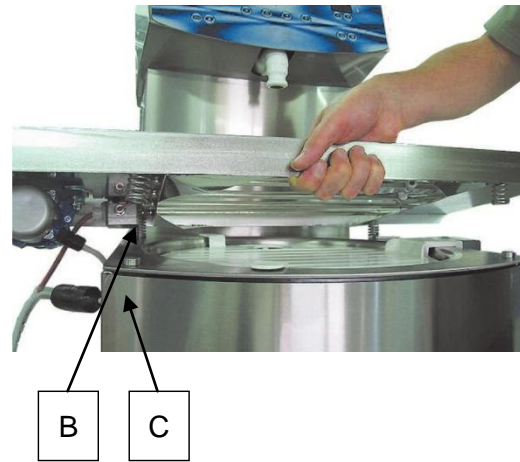

- Connection of the vibrating table

To complete the installation procedure of the vibrating table it is necessary to insert the plugs (E) into the sockets located at the side of the machine (E).

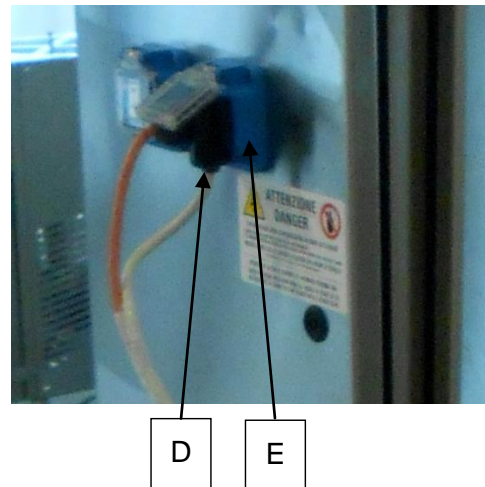

4.4. Commissioning

Check that all of the above-described procedures were done correctly.

Check that the emergency button is not pushed; if it is, release it.

Power-on the machine by pressing the button on the main switch. The LED on the control panel will light up to show that the machine is in STAND-BY.

Check that the safety and emergency protections and control devices are working correctly.

Make sure the work zone is free of all objects not needed for work and that there are no oil stains on the floor.

5. Operation section

5.1. Description of the controls

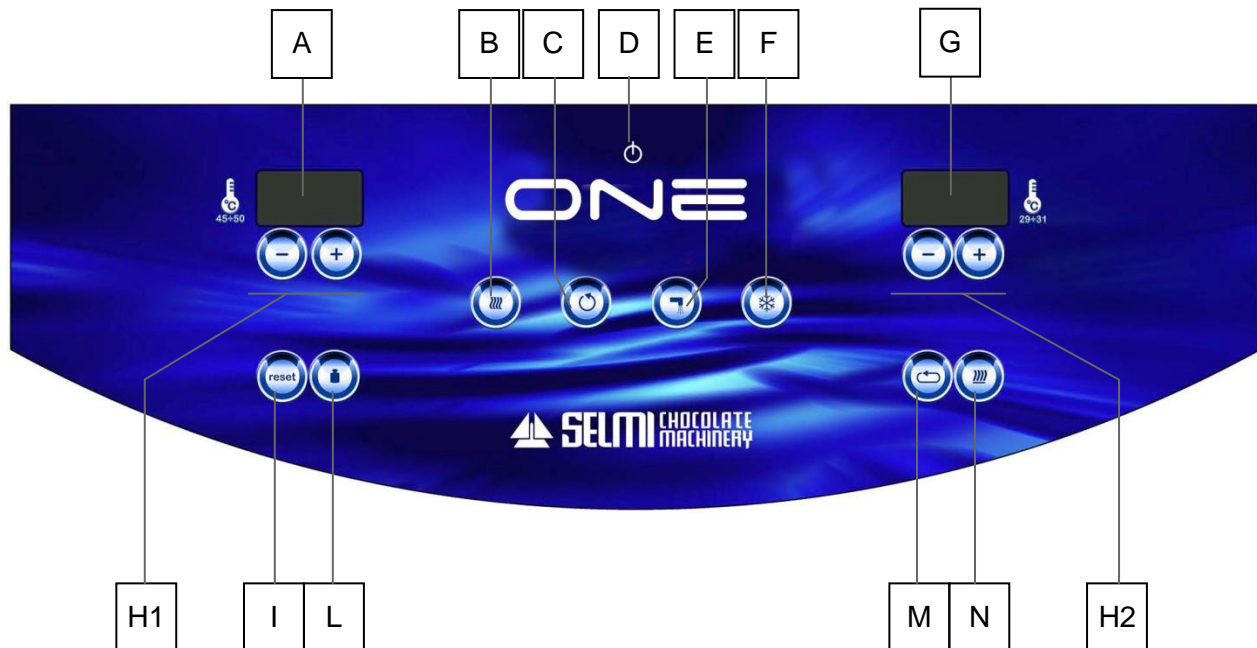

A	“Tank temperature” display
B	“Prewarm command” button
C	“Mixer command” button
D	STAND-BY led light
E	“Ascension pump motor” button
F	“Temper function” button
G	“Chocolate temperature” display
H1	“Tank temperature control” buttons
H2	“Tempering temperature control” button
I	“RESTORE FUNCTIONS” button
L	“Dispenser function” button
M	“Vibrating table initiator” button
N	“Vibrating table heating” button

5.2. Functions of the buttons

Attention

Before starting the machine, make sure that the operations described in the previous sections have been correctly performed.

Do not remove the protective and safety devices.



A) Tank temperature" display
Displays the tank temperature



B) "Prewarm command" button
Activates/deactivates the prewarm function



C) "Mixer command" button
Activates/deactivates the mixer rotation



D) STAND-BY led light
If on shows that the machine is on STAND-BY



E) "Ascension pump motor" button
Activate/deactivate the chocolate pump



F) "Temper function" button
Activates/deactivates the chocolate tempering function



G) "Chocolate temperature" display
Displays the temperature of the chocolate outflowing from the nozzle



H1) + button
Raises the values on the display.



H1) - button
Lowers the values on the display.
+ and – buttons on the left hand side raise or lower the tank temperature



H2) + button
Raises the values on the display.



H2) - button
Lowers the values on the display.
+ and – buttons on the right hand side raise or lower the discharge temperature of the chocolate



I) "RESTORE FUNCTIONS" button
In case of stalling, it restarts the functioning of the machine.



L) DISPENSER function button
Activates the volumetric dispenser



M) "Vibrating table initiator" button
Activates/deactivates the vibrating table



N) "Vibrating table heating" button
Turns on/off the vibrating table heating device

5.3. Using the machine

Attention

The machine must not be used by non authorised and non trained personnel. The operators who carry out consented activities on the machine must receive adequate instructions regarding personal protection equipment which will eliminate all risks associated with the various activities carried out.

5.3.1 Loading of chocolate and start of processing

Remove the tank protection grill and put the chocolate (solid or flakes) in the tank. Re-cover the tank with the grill. Press the black button on the main switch to switch on the machine; the led light (D) will switch on, indicating that the machine is powered up and is on STAND-BY.



Press the PREWARM button (B); the two side screens will display the tank and nozzle temperatures; the machine will start up, activating the resistances.

When the temperature displayed on the left hand side screen reaches the preset level, the machine will produce a sound to signal that the mixer can be activated.



Press the MIXER button (C) and the mixer will start mixing the chocolate in the tank

Note

The mixer motor will not operate if the detected temperature is lower than the preset one. The recommended temperature to set on display (A) is approximately 45°C.



The temperature of the product inside the tank



can be increased or decreased by pressing the H1 + and H1 – buttons



By pressing the “PUMP MOTOR” button (E) the pump motor will start operating and the chocolate will start to flow through the nozzle.

5.3.2 Using the temper function



After having turned on both the mixer motor and the pump motor, the temper process can be started by pressing the “Temper function” button (F)

When the temperature displayed on the right hand side screen will reach the preset level, the machine will emit a sound, indicating that the processing can begin.



The chocolate tempering temperature can be increased or decreased by pressing the H2 + and H2 – buttons



The recommended temper temperatures to be preset are shown in the following table:

chocolate	Dark	Milk	White
Tank temperature	30-31°C	29-30°C	28-29°C

Attention

These reference values are generic and need to be modified according to the quantity of cocoa butter contained in the product that is being processed.

Note

No solid product can be added in the tank during the tempering process. If more product is needed, it can only be added in liquid form during this phase of the process.

5.3.3 Volumetric dispenser

The machine is equipped with the "VOLUMETRIC DISPENSER" function which supplies preset quantities of chocolate upon the pressing of the pedal.



To activate this function press the "DISPENSER function" button (L).

On the left hand side display (A), the temperature value will be replaced by a weight amount expressed in grams. The memory can store up to 15 different weights.



To modify the weight press the H1+ or - buttons underneath the left hand side screen.



The weight can be increased or decreased in steps of 50 grams.



To modify the quantity keep the DISPENSER button (L) pressed for about 7 seconds (minimum variation is 1g).

With the volumetric dispenser activated and the pedal pressed, the machine will interrupt the supply for one second, after which the product will be weighed out according to the set data.

Keeping a constant pressure on the pedal will activate fixed cycles of pause and discharge.

Calibration of the volumetric dispenser

Note

The calibration of the volumetric dispenser must be carried out during tempering. It is suggested to calibrate the volumetric dispenser according to the type of chocolate that is being processed since the unit weight might be different.

Note

To carry out correctly the calibration of the volumetric dispenser the tank must be at least three-quarters full.



Press the DISPENSER button (L)



Press the H1 + and - buttons at the same time and keep them pressed for about 5 seconds till



the right hand screen (G) will display:

P S

(Higher weight).

Keeping the pedal pressed, collect the chocolate discharged by the machine by using a container of known weight.



Weigh the discharged chocolate and enter the net weight of the collected sample in the left hand screen (A) by pressing the H1+ and - buttons.



Press the H2- button to view the following text:

P I

(Lower weight).

Keeping the pedal pressed, collect the chocolate that the machine will discharge for a few seconds.



Weigh the chocolate once more and enter the net weight of the collected sample in the left hand side screen (A) by pressing the H1+ and - buttons.



Press the H2- button to view the following text:

P S

(Lower weight).



To complete the calibration of the volumetric dispenser press the H1 + and - buttons at the same time.



Checking the calibration

After the calibration has been completed it is recommended to carry out a check by operating as follows:



Press the DISPENSER button (L)



Select a preset weight by pressing the H1+ and - buttons and collect the sample that needs to be weighed.



If the net weight of the collected sample does not match the chosen preset weight, it is necessary to repeat the calibration procedure.



5.4. Position of the user

During the working cycle a sole operator is needed located in front of the working panel with easy access to the emergency button.

5.5. Involuntary electrical interruptions

If the voltage supply were to fail during the working cycle, restart the machine as described in section 5.3.

5.6. End of the working cycle

If, at the end of the working cycle, the user wishes to leave in the tank some residual chocolate it is recommended to carry out the following operations:



If the "temper function" is active, press button (F) to deactivate this function.

Wait for a few minutes until the nozzle chocolate temperature has increased to about 36°C.



Press in sequence the following buttons:



(E) PUMP MOTOR



(C) MIXER

(B) PREWARM



to bring the machine to STAND-BY (led light D on).

Now the machine can be turned off by pressing the red button on the main switch.

Note

At the end of the working cycle cover the chocolate tank with the supplied lid.

5.7 Warning messages

Warning or fault messages could appear while the machine is in use depending on the conditions detected by the electronic system:

A L L

P r O

This message notifies the user that the tank protection grill has been removed.

A L I

A L I

The sensor located on the nozzle has detected an abnormal temperature (lower than 0°C or higher than 65°C); it is likely that the probe has been damaged and needs to be replaced.

A L 2

A L 2

Same as the previous but concerning the column probe

A L 3

A L 3

Same as the previous but concerning the tank probe

A L 4

A L 4

Same as the previous but concerning the cooler circuit probe

A L 5

A L 5

Same as the previous but concerning the duct probe

A L 6

A L 6

Same as the previous but concerning the second tank probe

A S S

N A

Mixer motor abnormal power consumption

A S S

N r

Chocolate pump motor abnormal power consumption

A S S

2 2 0

Abnormal power consumption of a 230V power supply

A S S

2 4

Abnormal power consumption of a 24V power supply

6. Maintenance section

6.1. General information

Attention

The product present in the tank or internally to the machine must NEVER come into contact with water or other liquids: this may lead to the formation of moulds and bacterial loads.

Attention

If a bacterial presence is found on the product derived from the processing carried out with this machine model it will be necessary to stop production immediately and contact the manufacturer for the disinfection procedures.

Before carrying out maintenance or cleaning procedures on the machine, cover the tank with the supplied lid.

Never clean or lubricate components in motion.

Warning

Extraordinary maintenance on the machine is exclusively carried out by the technicians approved by the manufacturer.

The training course carried out only gives the client the base instructions for ordinary maintenance. The manufacturer suggests carrying out a full service every two years to guarantee the safety conditions.

Note

The maintenance technician must note on an appropriate logbook all the interventions carried out on the machine.

This section describes the ordinary checking and maintenance procedures needed to guarantee the correct functioning of the machine.

Any other intervention that may be necessary to eliminate anomalies or faults must be expressly authorised by the manufacturer.

For major repairs it is recommended to turn to the manufacturer whose specialised personnel, possessing the technical expertise acquired from the original manufacturing in the factory, are always reachable and able to intervene quickly.

For maintenance or replacement of commercial components installed on the machine keep to the instructions provided directly by the manufacturers.

Such instructions are normally attached to the components or obtainable via catalogues or manuals provided by the manufacturers.

Environment

The components replaced during maintenance operations must be disposed of according to the laws in force concerning waste materials. If necessary, they can be sent to the manufacturer, who will dispose of them in the most appropriate manner.

6.2. General safety practice

Attention

Before starting a maintenance procedure disconnect the machine from the mains and put in place all the necessary safety measures.

Attention

During maintenance procedures place on the machine, preferably on the control panel but in any case in a clearly visible location, a sign with the text: "MACHINE UNDER MAINTENANCE, DO NOT SWITCH ON".

Maintenance work must be carried out by specialised technicians who are trained in specific sectors, which for this machine are:

- mechanical maintenance technicians;
- electrical maintenance technicians.

It is the duty of the Safety Officer to ascertain the professionalism and competence of the maintenance technicians.



Before starting a maintenance procedure the safety officer must:

- 1) Clear the working area of extraneous materials and people.
- 2) Make sure that the necessary tools are conveniently available to the maintenance technician and that they are in good condition.
- 3) Make sure that the lighting is sufficient and provide, if necessary, portable low voltage lights.
- 4) Make sure that the maintenance technician is equipped with the necessary approved personal protection equipment for the specific operation (gloves, safety glasses, shoes, etc.).
- 5) Make sure that the maintenance technician has carefully read the instructions contained in this manual and has excellent knowledge of how the machine works.

At the end of every maintenance intervention the following procedures need to be carried out before restarting the machine:

- 1) Carefully clean the floor in the work area, removing any residues that may cause slippage
- 2) Lock the protective panels back into place, check the functionality of the interlocking parts and of the safety devices. Make sure to re-activate them if they were previously deactivated
- 3) Make sure that no extraneous components have been left in the machine, especially mechanical parts, utensils or components used for maintenance that could cause damage to the machine or put personnel at risk.
- 4) Before switching the machine back on make sure that all personnel are at a safety distance.
- 5) Before restarting the processing, the maintenance technician must check the entire working cycle, the functionality of the safety mechanisms and the integrity of the fixed protective panels.
- 6) before restarting the working cycle the machine must be cleaned according to the instructions in section 6.3.

Attention

Following every maintenance intervention it is the Safety Officer duty to ascertain that the machine is working properly and that all the safety devices are present and functional.

Unless expressly required for the solution of a breakdown, never interfere with the adjustments and positioning of the limit microswitches; their tempering can cause serious damage to the machine and pose risks to the operator.

Before assembling a block always cover with a thin layer of alimentary grade oil the internal parts and coupled surfaces. replace all the seals and gaskets with original parts before reassembling the components.

Note

Before reinstalling the machine components that have been washed with water or other liquids, check that they are completely dry.

Work on electrical components must only be carried out by the electrical maintenance technician specially trained and authorized by the Safety Officer.

6.3. Cleaning external parts

Attention

The chocolate present inside the tank and inside the machine must not come into contact with water or other liquids: there is a risk of mould formation leading to bacterial presence.

Attention

Use appropriate personal safety equipment while carrying out the cleaning of the machine.

Clean persistent stains with dry and soft clothes that do not fray or use flexible bristle brushes.

If the stains are incrustated and hard to remove with dry clothes or brushes use a liquid solvent appropriate for use in an alimentary environment. Avoid the use of flammable or toxic solvents.

Clean the signalling plaques with a cloth, soap and water or any other mild liquid; avoid using chemical solvents.

Before beginning and at the end of every maintenance operation it will be necessary to vacuum away the dust and other residues, recurring to using appropriate solvents if necessary but avoiding the use of compressed air jets which can create zones of dirt accumulation and may cause injury to the individuals present in the area.

6.4. Emptying and cleaning the machine

6.4.1 Emptying the machine

To clean the parts of the machine in contact with or in proximity of the product it will first be necessary to completely empty the tank by following these steps:

- 1) remove the rear protective panel as described in section 6.5.1 in order to access the chocolate discharge point
- 2) start the machine and wait for the product to reach the right temperature
- 3) turn on the mixer and the ascension pump motor and drain from the nozzle as much chocolate as possible till the tank is empty. Collect the chocolate in a container suitable for foodstuffs
- 4) turn off the ascension pump motor and the mixer motor
- 5) place a container suitable for foodstuffs underneath the chocolate draining point making sure it is big enough to contain all the product inside the machine
- 6) open the tap of the discharge point and start the mixer and wait for all the chocolate to exit the machine
- 7) stop the machine by opening the top grill and check that there is little residual product left;
- 8) use an alimentary grade spatula to move as much product as possible towards the centre of the tank
- 9) once the residual product in the tank is at a minimum, close the tap of the discharge point and proceed with the removal of the mixer and wash it in warm water

When there is a really minimum amount of product in the tank, the mixer is removed and washed in hot water.

Warning

To easily remove drops and traces of product wait for the warming elements of the machine to have cooled down.



6.4.1 Tank and mixer cleaning

ATTENTION

DON'T USE WATER TO CLEAN THE TANK;
If you are using paper to clean the tank,
make sure that no pieces of paper will fall
into the holes (A)

For a correct cleaning of the tank follow the steps:

- Pull off the mixer and clean it.
- Is allowed to use the dishwasher for the mixer cleaning
- Make sure the mixer is completely dry before repositioning it in its place.

After the mixer extraction:

- remove the remaining chocolate with a spatula.
- clean the tank with a cloth.

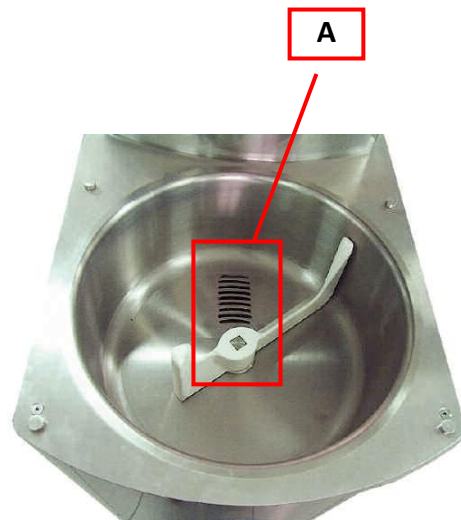

6.4.2 Cleaning of the nozzle

If the chocolate exit nozzle (A) needs to be cleaned, proceed as follows:



- 1) Turn off and unplug the machine
- 2) Open and anchor the upper protective panel as described in section 6.5.1
- 3) Loosen the nozzle's blocking knob (B)



- 4) Lift the nozzle's holding hook (C)



- 5) Remove the nozzle without applying excessive force, as shown in the following picture



Wash the nozzle with warm water and dry it thoroughly by using a warm air jet if necessary.

Note

Before reinstalling the machine components that have been washed with water or other liquids, check that they are completely dry; contact of the product with water could cause the formation of mould or bacteria.



6.3.3 Fridge group filter cleaning

For to clean the fridge group filter follow the step below:

1. Unscrew the two knobs (S).
2. Remove the fixing support (T).
3. Remove the filter (F) from his place.
4. Clean the filter with air compressed.
5. Replace the filter.

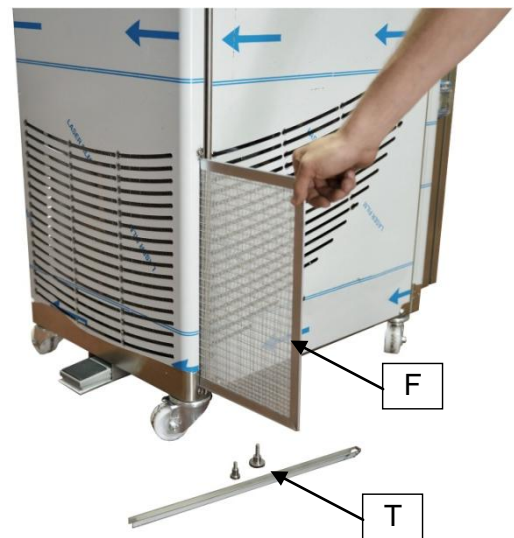
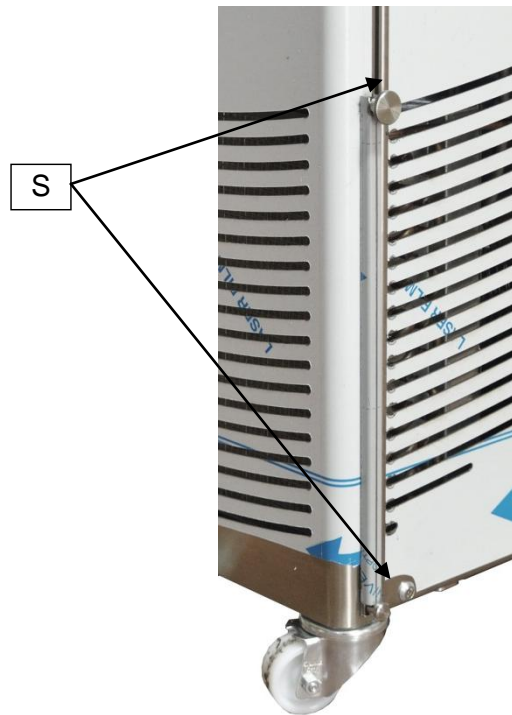

6.5. Maintenance of mechanical parts

If detailed diagrams are not available take note of every item and mark its location so as to avoid errors in reassembling.

Always use spanners of the correct size.

Immediately replace screws or bolts which show signs of wear on the threads and the heads. When screwing and unscrewing do not use the spanners in conjunction with extensions to augment the torque. If dynamometric spanners and special tools are used verify that the calibration is appropriate for the component.

Special care must be taken when using pneumatic or hydraulic tools.

Before dismantling heavily oxidised components spray them with deoxidising agents.

Before reassembling cover thinly with oil all the coupled surfaces.

During reassembly pay particular attention to anti-slip devices used by the manufacturer (flat washers, elastic washers, etc.), always replacing the worn out elements.

The ring nuts and anti-slip nuts with plastic blocking rings must be replaced at every reassembly since the fatigued material will deform and lose its functionality.

Attention

During maintenance procedures always use appropriate personal protection equipment.



Use exclusively original SELMI spare parts. The manufacturer will take no responsibility for accidents or damages in the case of use of non-original spare parts.

6.5.1 Removal of the fixed lateral, rear and upper fixed protective panels

Attention

Do not start the machine with the protective panels removed or incorrectly screwed into place.

Do not forget cloths, spanners or other maintenance tools inside the machine.

In order to remove the lateral fixed protective panels follow this procedure:

- 1) Unplug the machine
- 2) Position the machine in a spacious area so as to allow easy access
- 3) Put the provided anti-dust lid on the tank in order to prevent contamination of the product
- 4) Identify the location of the panel fixing screws (A)





- 5) Loosen with an appropriate tool (not supplied) all fixing screws of the panel which needs to be removed
- 6) Remove the screws one at a time, keeping the panel in place until all screws are removed



- 5) Loosen with an appropriate tool (not supplied) all fixing screws of the panel which needs to be removed



- 7) Using both hands lift the panel out of position and place it, preferably horizontally, on the floor or on a level surface. Make sure that it is not in the way and that it cannot fall or create risks to others working in the vicinity of the machine

- 6) Remove the screws one at a time, keeping the panel in place until all screws are removed
- 7) Using both hands lift the panel out of position and place it, preferably horizontally, on the floor or on a level surface. Make sure that it is not in the way and that it cannot fall or create risks to others working in the vicinity of the machine

In order to remove the rear fixed protective panel follow this procedure:

- 1) Unplug the machine
- 2) Position the machine in a spacious area so as to allow easy access
- 3) Put the provided anti-dust lid on the tank in order to prevent contamination of the product
- 4) Identify the location of the rear panel fixing screws (B)

The side and rear protective plates have loss-proof screws (D) with plastic washer (E). These screws remain attached to the plate if it is removed, preventing loss of the fastening screws and consequent incorrect positioning of the plate.

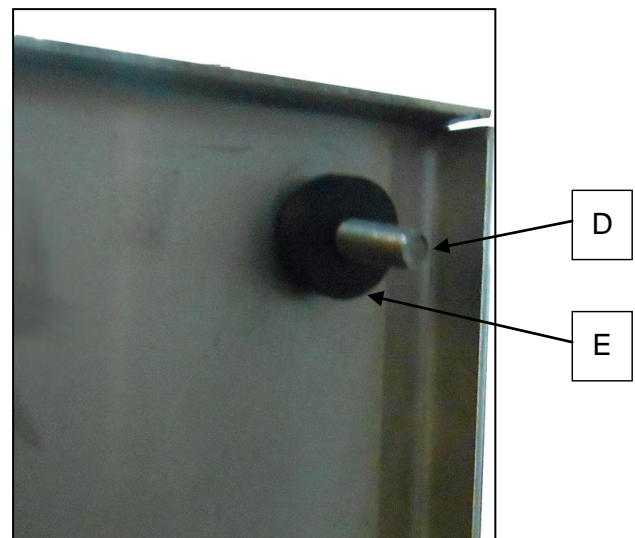
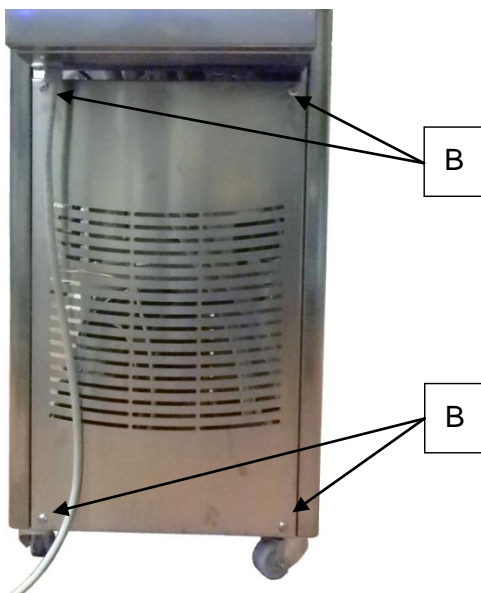

In order to remove the upper protective panel follow this procedure:

- 1) Unplug the machine
- 2) Position the machine in a spacious area so as to allow easy access
- 3) Put the provided anti-dust lid on the tank in order to prevent contamination of the product
- 4) Identify the location of the upper panel fixing screws (F) and unscrew them.



- 5) Lift the front side of the upper protective panel until it hooks on the edge of the rear panel (G)

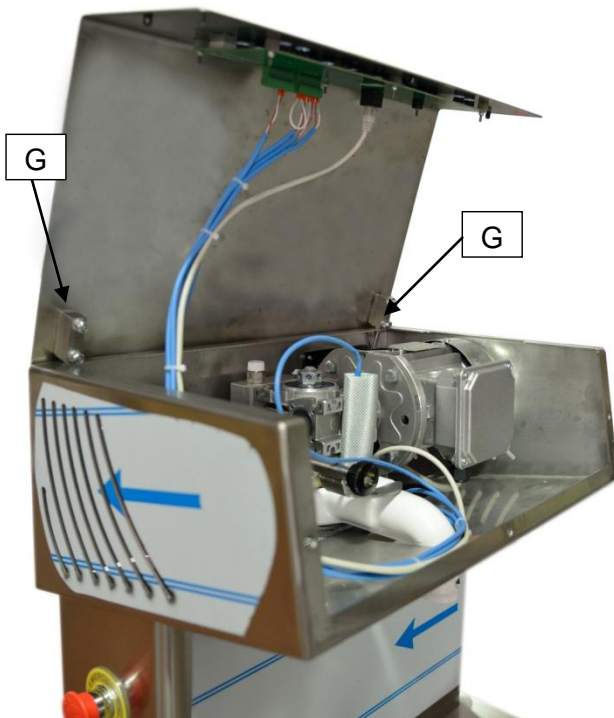

6.5.2 Level check and top up of the cooling liquid

To check the level of cooling liquid and top it up, it is necessary to:

- 1) Lift the cap of the cooling liquid reservoir (H)

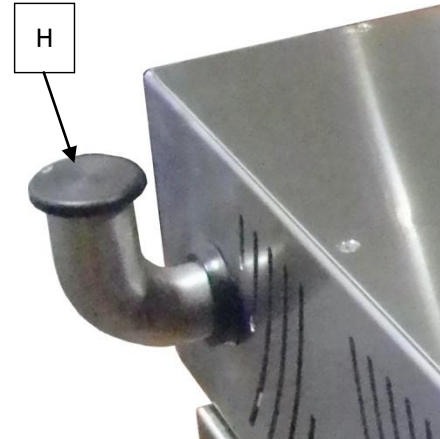

- 2) Check that the liquid is visible inside the pipe
- 3) If the liquid is not visible, top up with distilled water
- 4) Top up until about three centimeters are left between the liquid and the top of the pipe
- 5) Purge the cooling system as described in section 6.5.3
- 6) Check once more the level of the liquid and top up again if necessary
- 7) Seal the reservoir by putting the cap back in place



6.5.3 Purging the cooling system

After topping up the cooling liquid it might be necessary to purge the cooling system by following this procedure:

- 1) Remove the upper protective panel as described in section 6.5.1
- 2) Identify the purging tap (L)

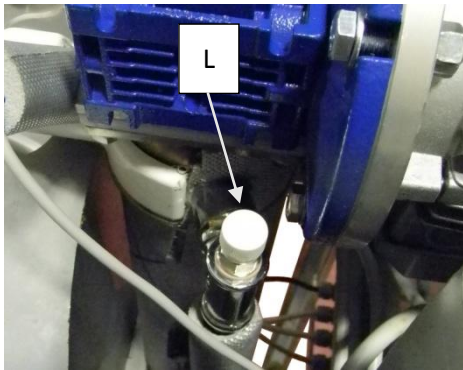

- 3) Put a piece of alimentary grade paper in front of the purging tap's opening and keep it in position with your hand



- 4) Slowly loosen the purging valve by rotating it anticlockwise until a small quantity of cooling liquid is discharged
- 5) Tighten the valve and put the upper protective panel back in place

Note

The topping up and purging procedures must be carried out only if the machine is turned off and unplugged.

6.5.4 Replacement of the reducer

If the reducer were to malfunction replace it as follows:

- 1) Empty the machine as described in section 6.4.
- 2) Wait for the product to cool down
- 3) Remove the fixed protective panels as described in section 6.5.1
- 4) Disconnect the motor as described in section 6.6.1
- 5) Remove the screws holding the electric motor to the reducer
- 6) Detach the motor from the reducer and place it on the floor. Take care not to lose the small key located on the motor drive shaft
- 7) Free the low speed shaft inside the machine by removing the blocking mechanism located below the reducer
- 8) Proceeding with caution, remove the screws holding the reducer to the machine and place it on the ground
- 9) Install the new reducer taking care to correctly position the central shaft
- 10) Re-attach the reducer to the machine by using the screws
- 11) Re-instate the blocking mechanism of the low speed shaft
- 12) Insert the motor shaft into the reducer taking care to correctly reposition the small key
- 13) Attach the motor to the reducer via the screws
- 14) Put the fixed protective panels back in place

6.5.5 Replacing the motor

To replace the motor act as follows:

- 1) Disconnect the motor as described in section 6.6.1
- 2) Remove the screws that attach the motor to the reducer
- 3) Detach the motor from the reducer, taking care not to lose the small key present on the motor shaft, and place it on the ground
- 4) Insert the shaft of the new motor into the reducer taking care to correctly reposition the small key
- 5) Attach the motor to the reducer via the screws
- 6) Reconnect the motor as described in section 6.6.1
- 7) Put the fixed protective panels back in place

6.6. Maintenance of electrical system

Attention

Before taking any action on electrical components disconnect the machine from the mains.

Always carefully check the isolating covers, the clamps and the grip of the sheaths; seal gaskets cannot guarantee the IP level of protection declared by the manufacturer if they are not correctly positioned or if they are damaged.

Replace sheaths and cables if their isolating covers are ruined or damaged.

Check and restore, if necessary, the identification labels and stickers of the wires and of the components keeping to the indications shown in the electrical diagrams.

Make sure that the identification plate of the electric panel (see section 1.9) and the adhesive electric hazard plaque (see section 2.3) are perfectly legible and firmly attached; otherwise replace them by requesting new ones from the manufacturer.

The replacement of faulty control components must always be carried out according to the norms in force, using components with technical characteristics complying with those of the components that need to be replaced.



Use exclusively original SELMI spare parts
The manufacturer will take no responsibility for accidents or damages in the case of use of non-original spare parts.

6.6.1 Disconnection and reconnection of the motor

If the motor needs to be replaced an electrical technician will need to intervene. He will firstly have to disconnect the damaged motor and then connect the new motor.

Follow these steps to disconnect the motor:

- 1) Remove the lateral fixed protective panels following the instructions given in section 6.5.1
- 2) Remove the screws of the connection terminal protective box
- 3) Disconnect the wires paying attention to the terminal each wire is connected to. You will need to remember this when you come to reconnect the wires
- 4) Free the cable from the cable holder that holds it to the motor and pull it out

Attention

Never connect the power supply when one or more of the electrical components of the machine are disconnected and the conductors are not correctly isolated.

To connect the new motor follow these steps:

- 1) Make sure that the electrical characteristics of the new motor are compatible with the original one's
- 2) Unscrew the protective box of the connection terminal
- 3) Reinstall the motor power cable into the appropriate cable holder
- 4) Tighten the cable holder until it has a good grip of the cable, paying attention not to use too much force, as there is danger of damaging the cable or the cable holder
- 5) Reconnect the wires into the connection terminal
- 6) Remount the protective box of the connection terminal and fix it in place with the screws.



6.6.2 Replacement of fuses

To replace the fuses act as follows:

- 1) Unplug the machine
- 2) Open the electric panel by releasing the lateral hooks
- 3) Remove each fuse from the power board and individually check their continuity until the faulty one is found. Remove only one fuse at a time; once checked, if the fuse is not faulty, put it back in place before removing the next one.
- 4) Replace it with a new fuse having the same electrical characteristics and dimensions
- 5) Check that the fuse caps have been correctly put back on
- 6) Close the electric panel and check that the machine is working correctly

Warning

When checking the continuity of the fuses make sure that they are not on a conducting surface.

Warning

Repeated blowing of fuses could be caused by problems related to devices installed on the machine; in this case contact Technical Services.

6.6.3 Replacement of the display board

To replace the display board (see photo on page 4, item 1) follow this procedure :

- 1) Unplug the machine
- 2) Open the upper protective panel following the instructions given in section 6.5.1
- 3) Remove the display board connecting cable and the connections to the probes, making sure to label the position of each cable
- 4) Unscrew the display board and remove it
- 5) Slot in the new display board and tighten it into place as it was originally
- 6) Reconnect the wires to the probes, making sure to reinsert the wires in the correct terminals and tighten the screws
- 7) Reinsert the display board connecting cable

The electronic board is sensitive to static discharges; we suggest handling it with caution, avoiding touching the printed circuit tracks.

6.6.4 Replacement of the power board

When replacing the power board (see photo on page 5) follow these steps:

- 1) Unplug the machine
- 2) Open the electric panel by using the provided key
- 3) Remove the plug in terminals from the power board along with the display board connecting cable
- 4) Disconnect the screw terminal wires, labelling them in order to be able to reconnect them correctly
- 5) Unscrew the power board and remove it, paying attention not to move the spacers that keep it separated from the metallic casing of the electric panel
- 6) Slot in the new power board and tighten it into place as it was originally
- 7) Reconnect the wires into the screw terminals, paying attention not to invert their original positions
- 8) Reinsert the plug-in terminals correctly
- 9) Reinsert the display board connecting cable

The electronic board is sensitive to static discharges; we suggest handling it with caution, avoiding touching the printed circuit tracks.

6.7. Components subject to wear and tear

Attention

Components subject to wear and tear due to their function must be periodically checked and replaced when they show noticeable signs of wear.

The manufacturer has designed and built the machine to last for a reasonable amount of time taking into consideration its intended use; it is nevertheless necessary to periodically carry out checks to verify the state of the components subject to wear and tear.

If structural deformations or fissures in the metallic components or in the soldering are found, immediately contact the manufacturer's customer service; the expert technicians will help you to take the necessary steps.

Due to their manufacturing properties, heating elements undergo a reduction of their isolating properties over time, particularly when exposed to a high level of humidity. Periodically check the functioning of the circuit breaker, provided for the protection of the machine.

All electrical components having mechanical moving parts during the working cycle (buttons, relays, etc.) are guaranteed by the manufacturer for a high, but always limited, number of cycles.

Periodical cleaning of the inner part of the electric panel prevents these elements from being subject to further mechanical fatigue.

6.8. Planned preventive maintenance

Thanks to the correct use of the machine and to the appropriate planned preventive maintenance it is possible to obtain the highest reliability from the machine at a minimum maintenance cost. Furthermore, through periodic checks, mechanical or electrical faults will come to light before these cause damage to the machine or pose risks to personnel.

Note

Strictly respect the maintenance time intervals and space them out according to the specific necessities in relation to the productive cycle of the machine.

Here below is a list of periodic checks suggested by the manufacturer:

Before and at the end of each working cycle:

Cleaning of the external parts of the machine (see section 6.4)

Before starting each working cycle:

Check that the emergency stop button is functioning correctly: press the emergency stop button while the machine is switched on and check that the main switch trips, cutting off the power to the machine.

Check that the grill safety micro switch is functioning correctly: lift the grill while the machine is switched on and check that the main switch trips, cutting off the power to the machine.

Every month:

Check the state of the internal components of the machine: follow the instructions given in section 6.5.1, remove one of the lateral fixed protective panels and check that there are no signs of humidity inside the machine induced by other nearby machines.

Check the level of the cooling liquid:

Follow the instructions given in section 6.5.2

Every six months:

Check that the safety micro switch of the electric panel door is functioning correctly: open the door of the electric panel while the machine is switched on, check if the main switch trips, cutting off the power to the machine.

Check the state of the mechanical fixings of the internal components: follow the instructions given in section 6.5.1, remove the lateral and rear fixed protective

panels and check, by using the appropriate tools, that the components' fixing screws are not loose.

Purging the cooling liquid system:

follow the instructions given in section 6.5.3

Warning

The manufacturer suggests carrying out a full service every two years to maintain the safety aspects of the machine over time.

Note

The machine is for professional use: it is therefore necessary to strictly respect the legislation in force regarding the periodic checks to the electrical circuits.

The manufacturer recommends the logging of all planned maintenance and extraordinary interventions, including dates and reasons for the interventions.



7. Technical diagrams section

7.1. Electrical circuit diagram

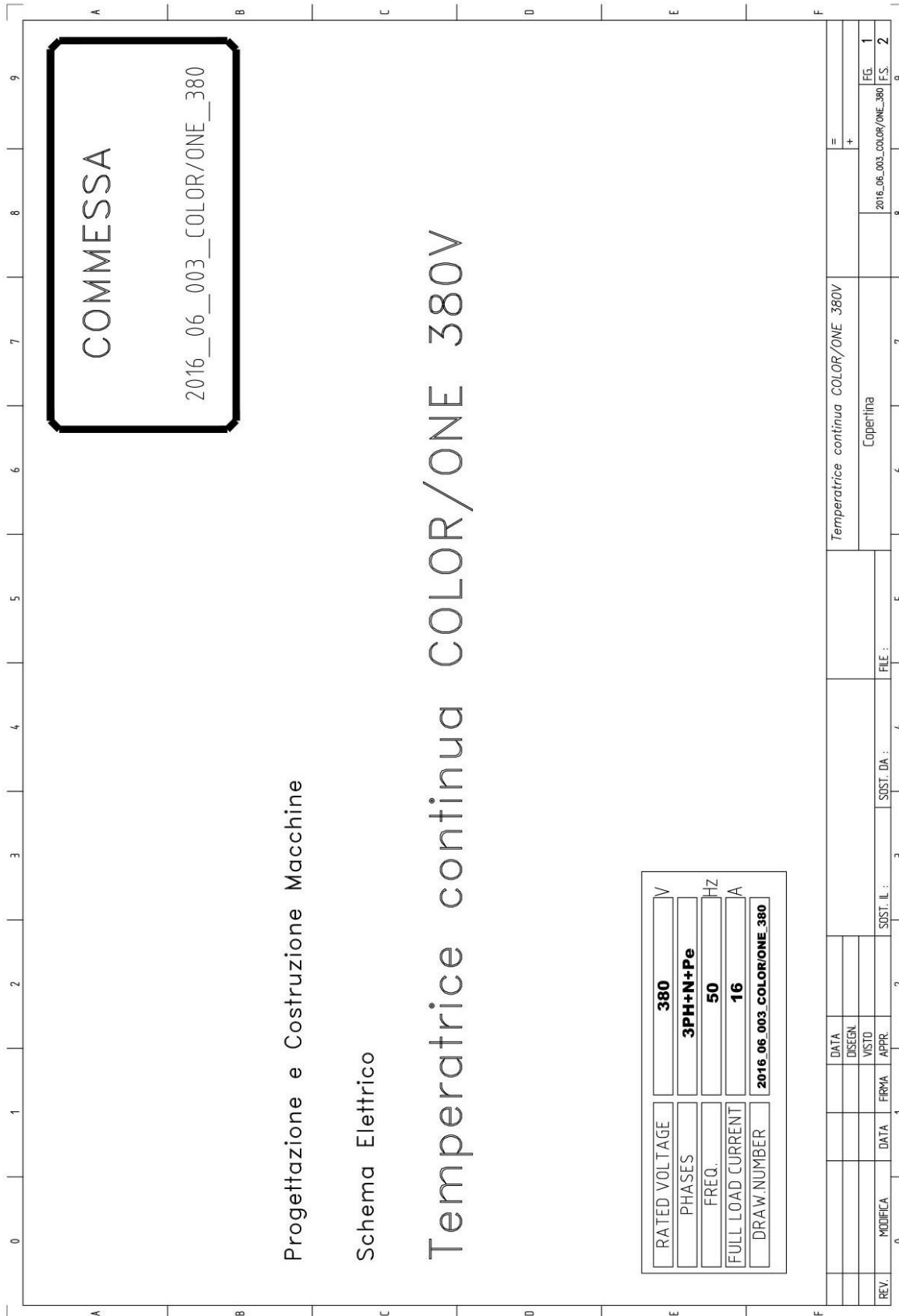

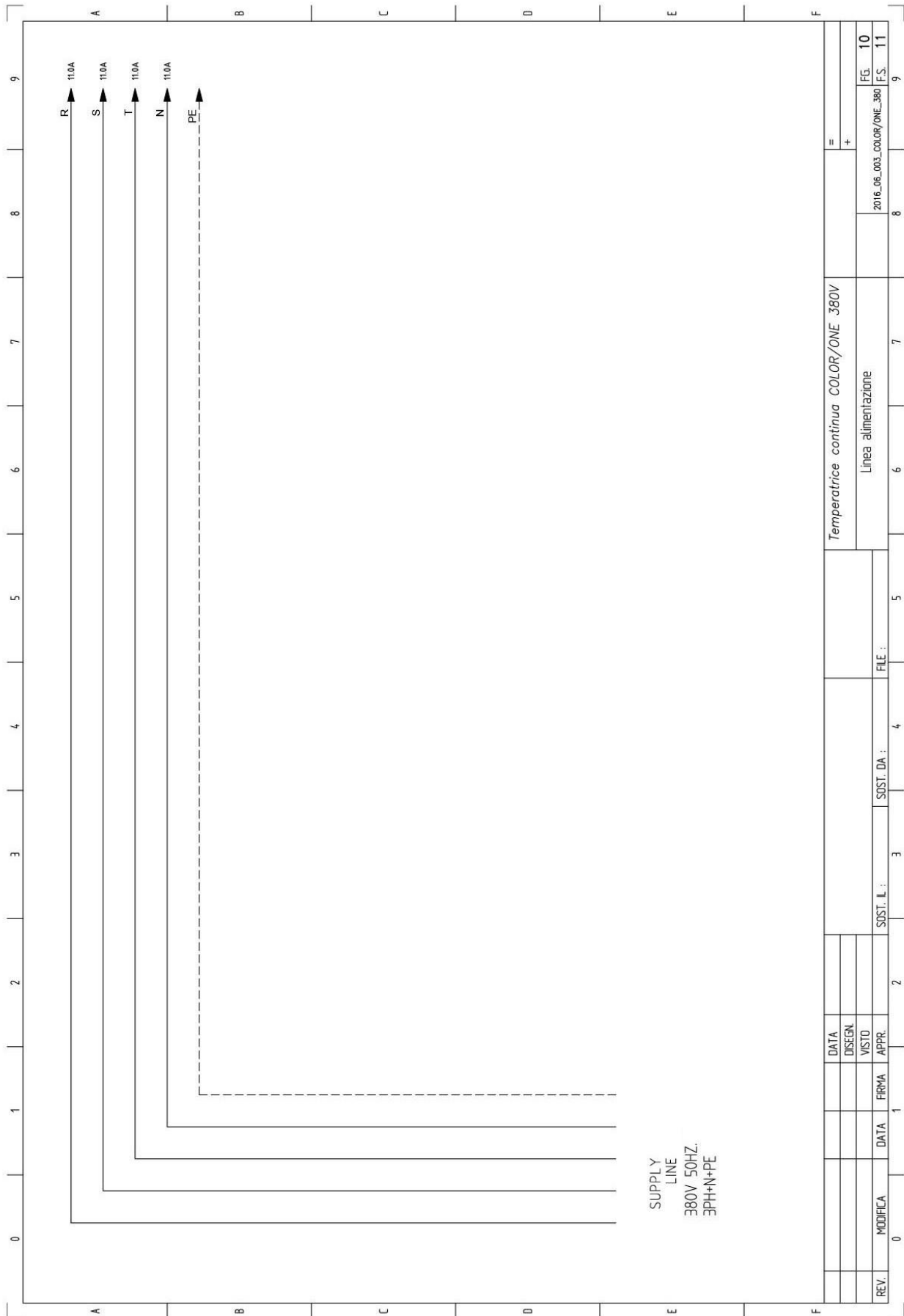

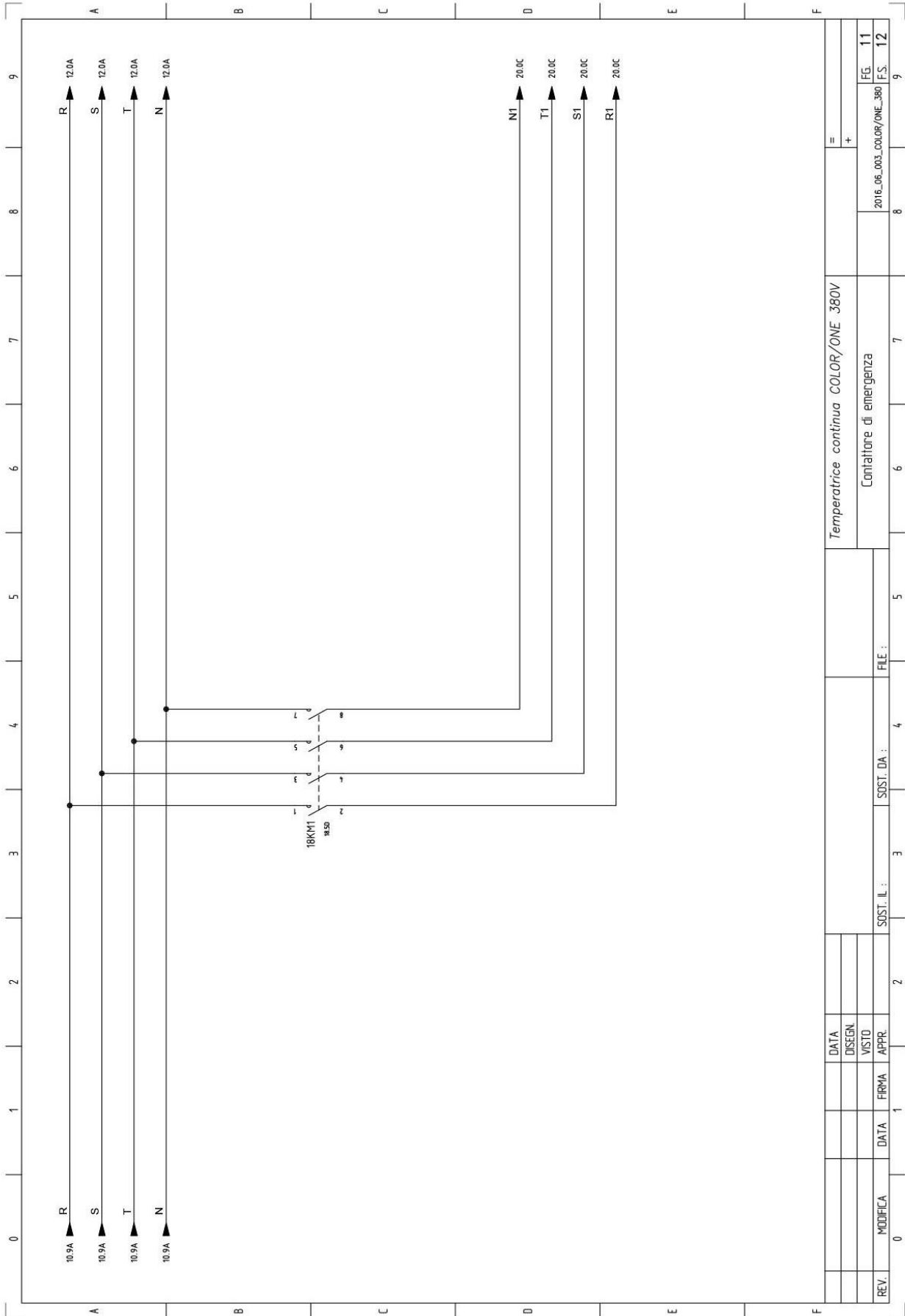

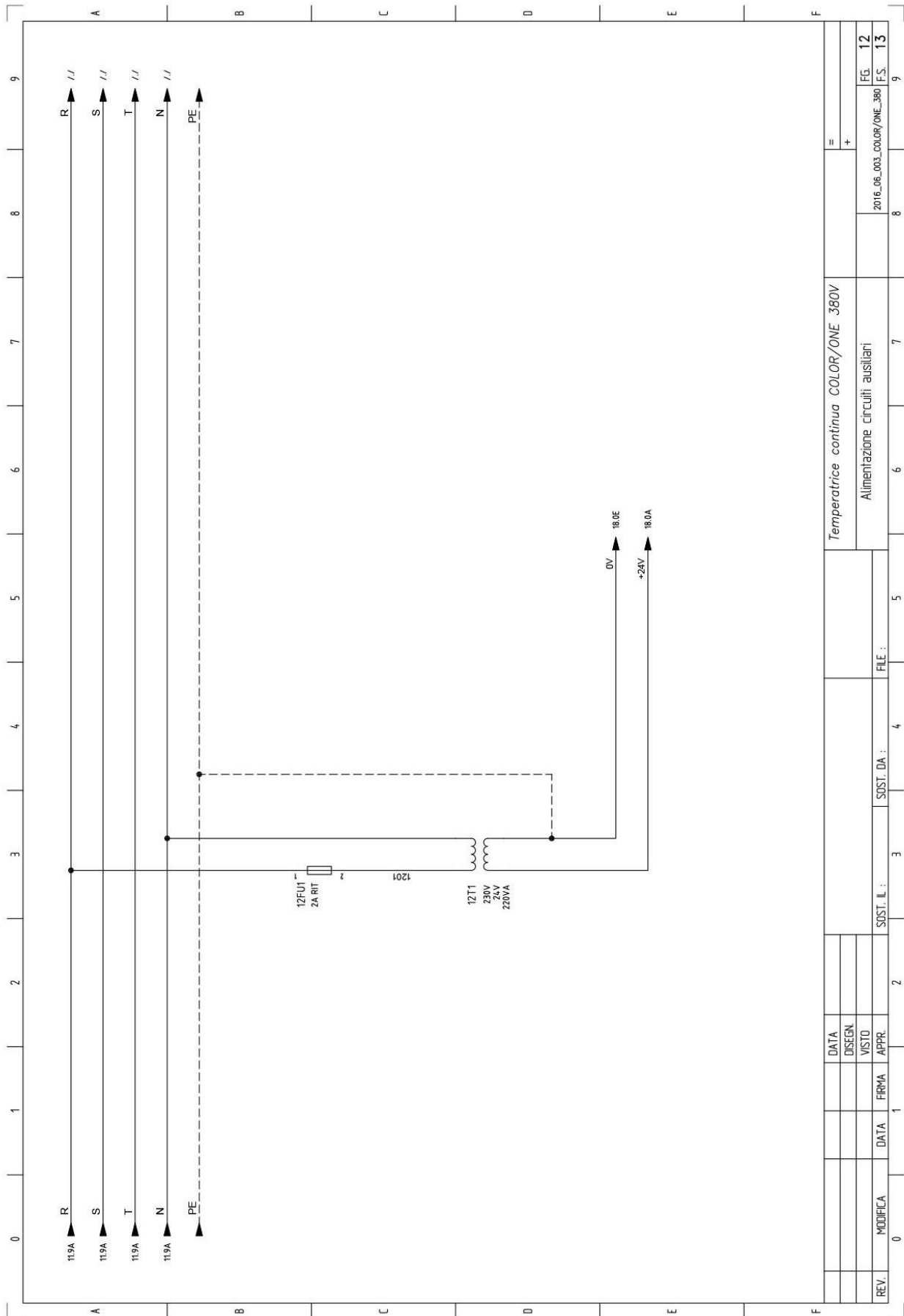

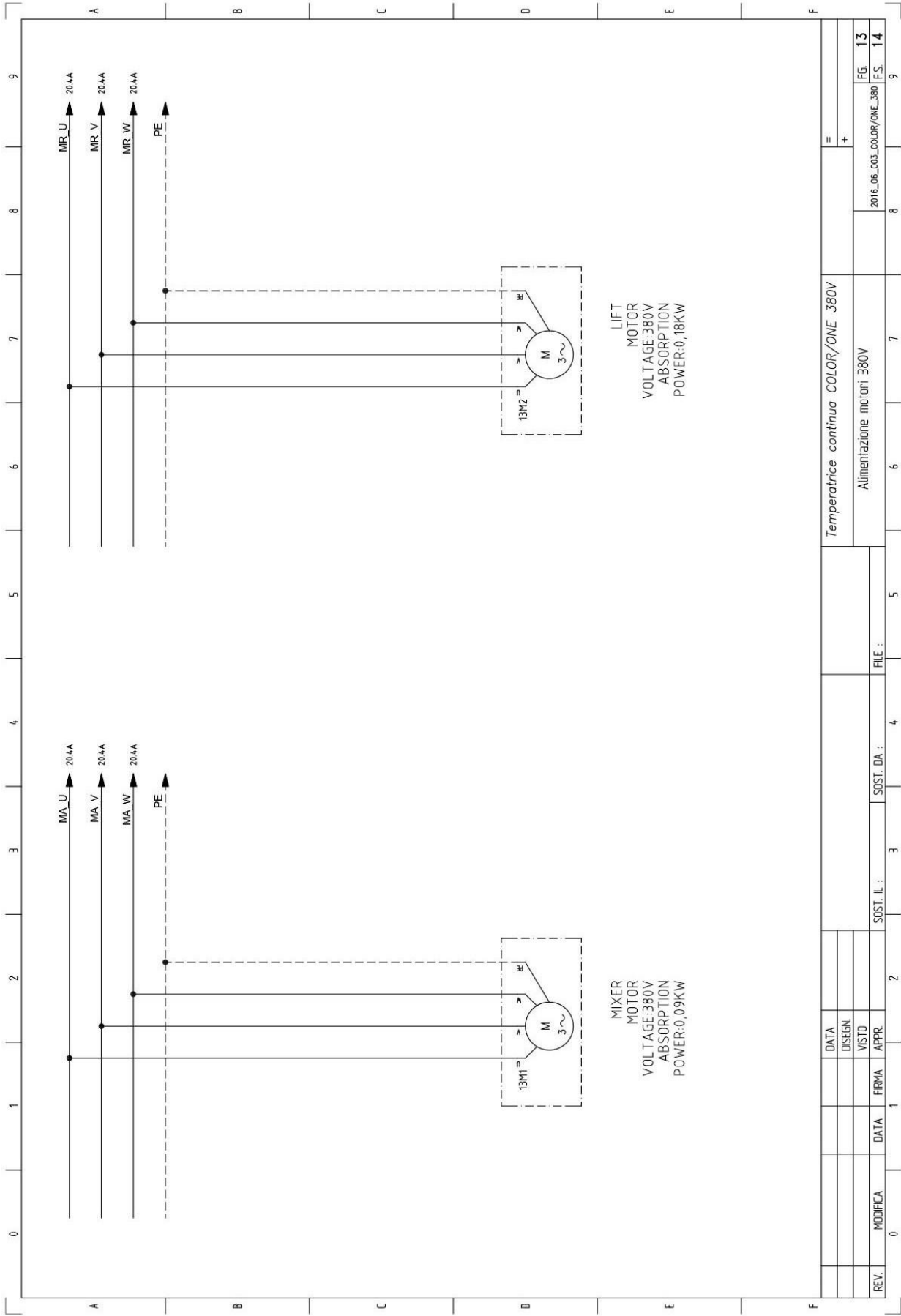

REV.	MODIFICA	DATA	FIRMA	APPR.	SOST. IL :	SOST. DA :	FILE :	Temperatrice continua COLOR/ONE 380V		=	
								Alimentazione motori 380V		+	
								2016_06_003_COLOR/ONE_380		FG. 13	9
										F.S. 14	

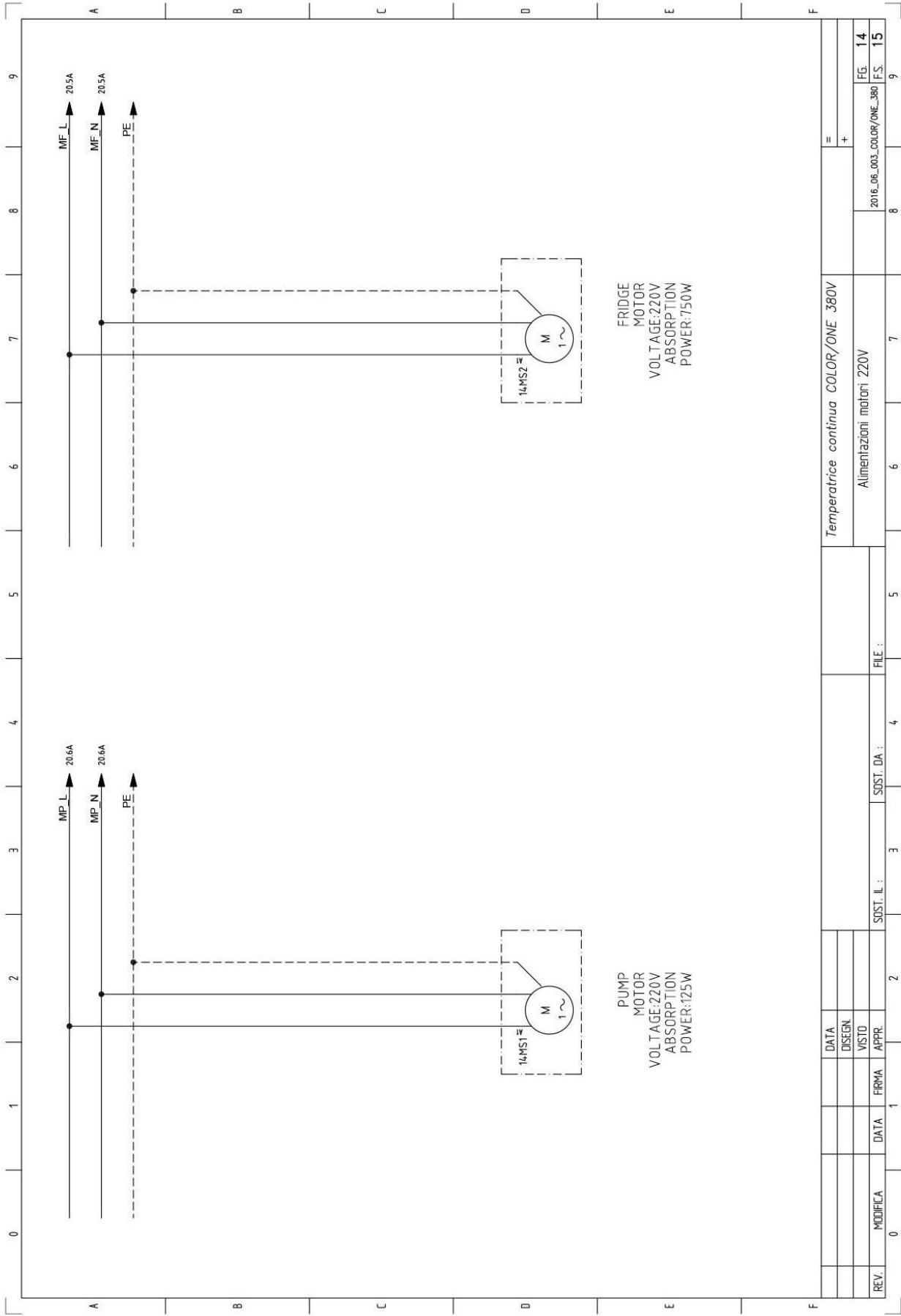

REV.	MODIFICA	DATA	FIRMA	APPR.	FILE :	SOST. IL :	SOST. DA :	0	1	2	3	4	5	6	7	8	9
													Temperatrice continua COLOR/ONE 380V		=		
													Alimentazioni motori 220V		+		
													2016_06_003_COLOR/ONE_380		FG. 14		
															F.S. 15		

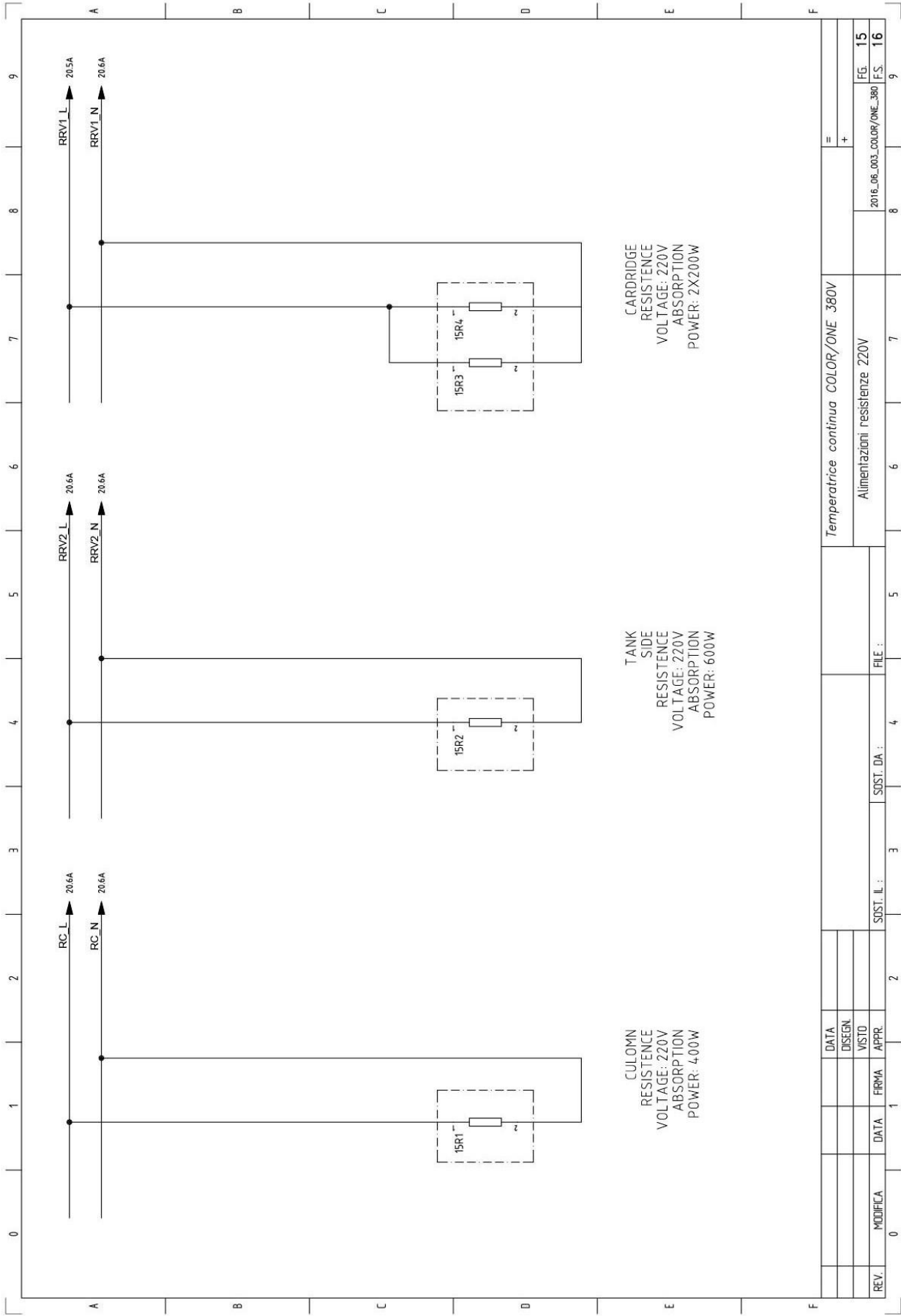

REV.	MODIFICA	DATA	FIRMA	APPR.	SOST. IL :	3	SOST. DA :	4	FILE :	5	Temperatrice continua COLOR/ONE 380V		+	FG.	15
											Alimentazioni resistenze 220V			F.S.	16

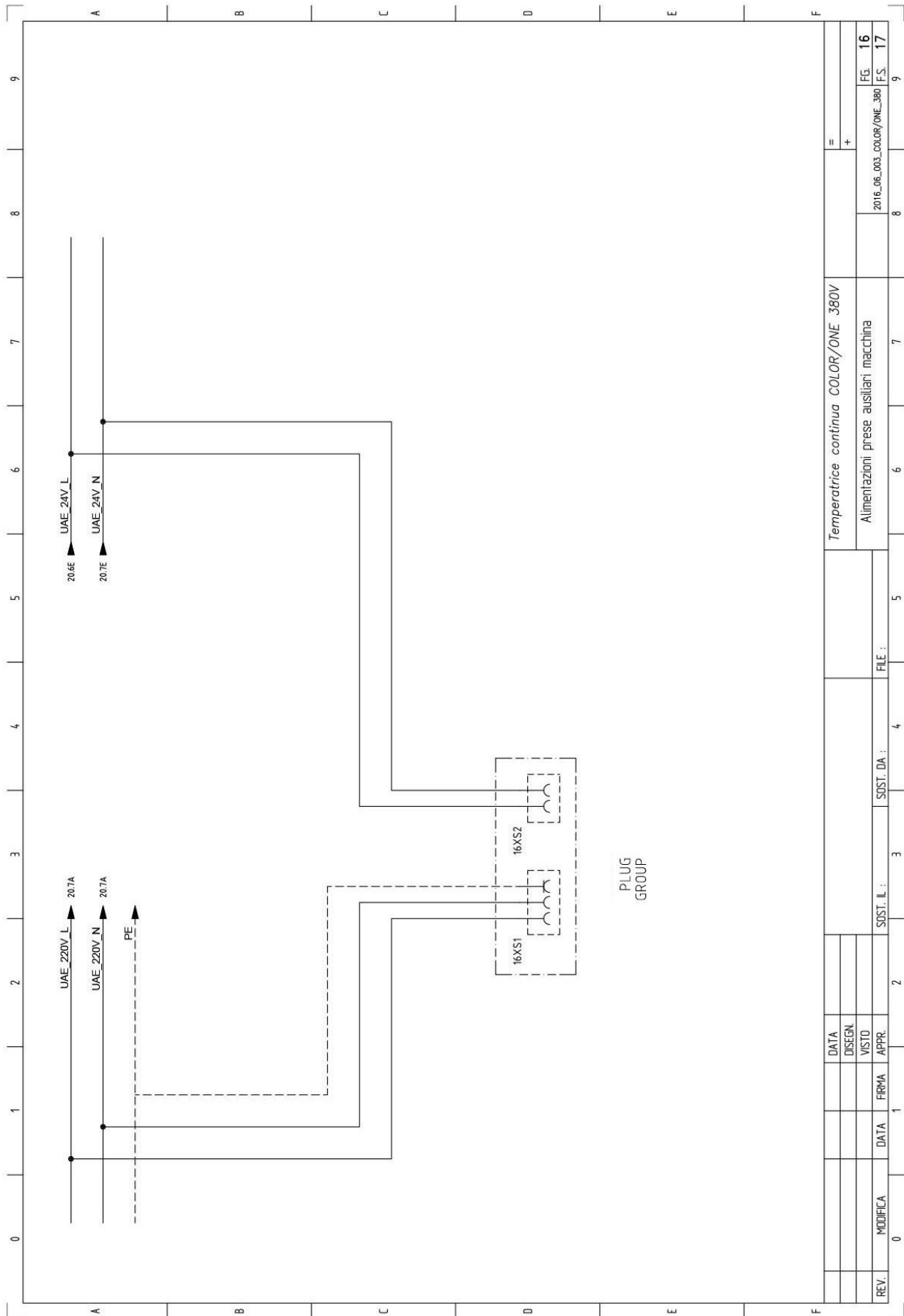

REV.	MODIFICA	DATA	FIRMA	APPR.	SOST. IL :	SOST. DA :	FILE :	2016_06_003_COLOR/ONE_380	FG.	16
									F.S.	17
Temperatrice continua COLOR/ONE 380V								=		9
Alimentazioni prese ausiliari macchina								+		

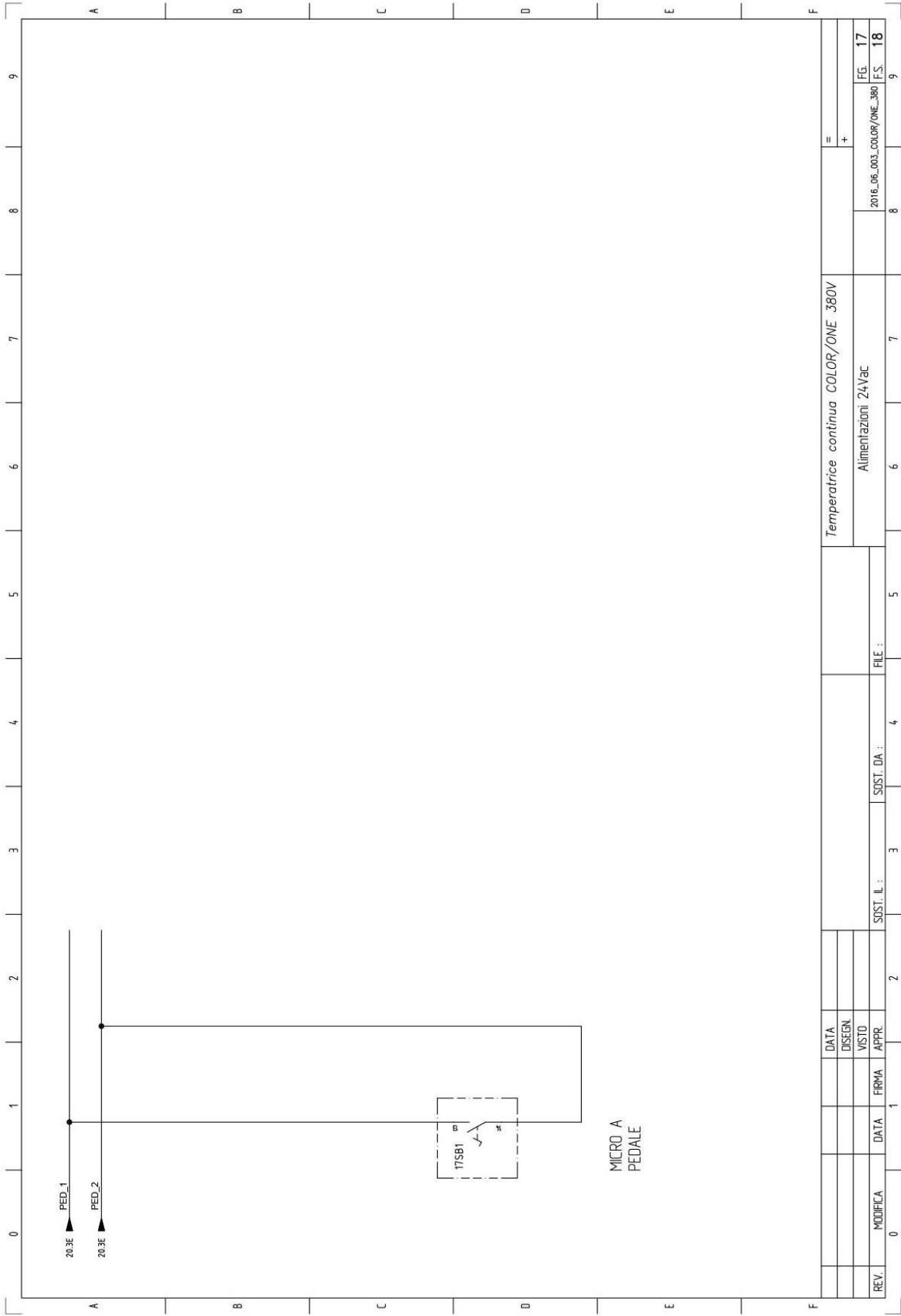

REV.	MODIFICA	DATA	FIRMA	APPR.	SOST. IL :	3	SOST. DA :	4	FILE :	5	Alimentazioni 24Vac	2016_06_003_COLOR/ONE_380	FG.	17
											Temperatrice continua COLOR/ONE 380V			

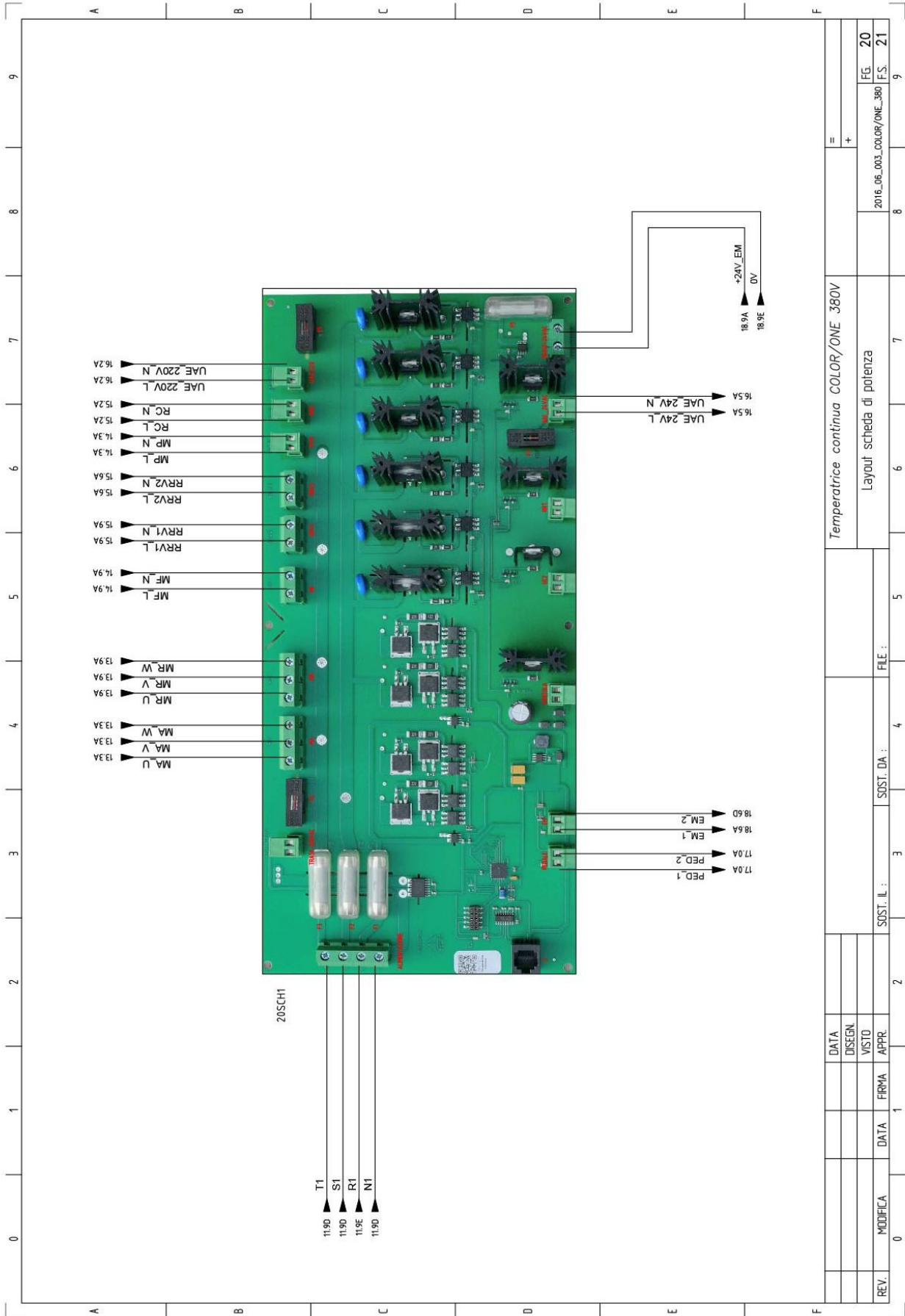

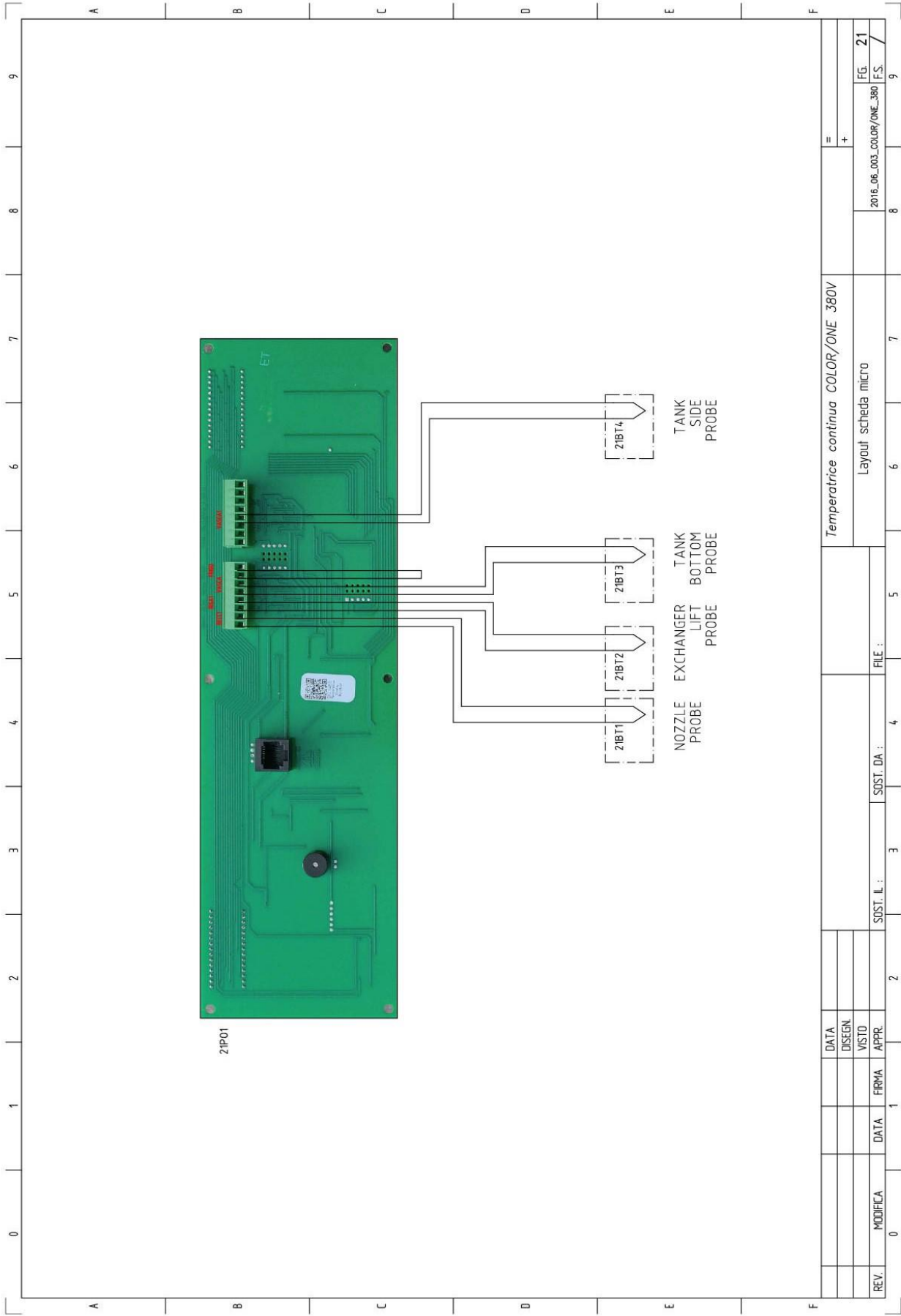

REV.		MODIFICA	DATA	FIRMA	APPR.	SOST. IL :		SOST. DA :		FILE :	Temperatrice continua COLOR/ONE 380V Layout scheda micro		2016_06_003_COLOR/ONE_380 F.S.		FG.	21

7.2. Cooler circuit diagram

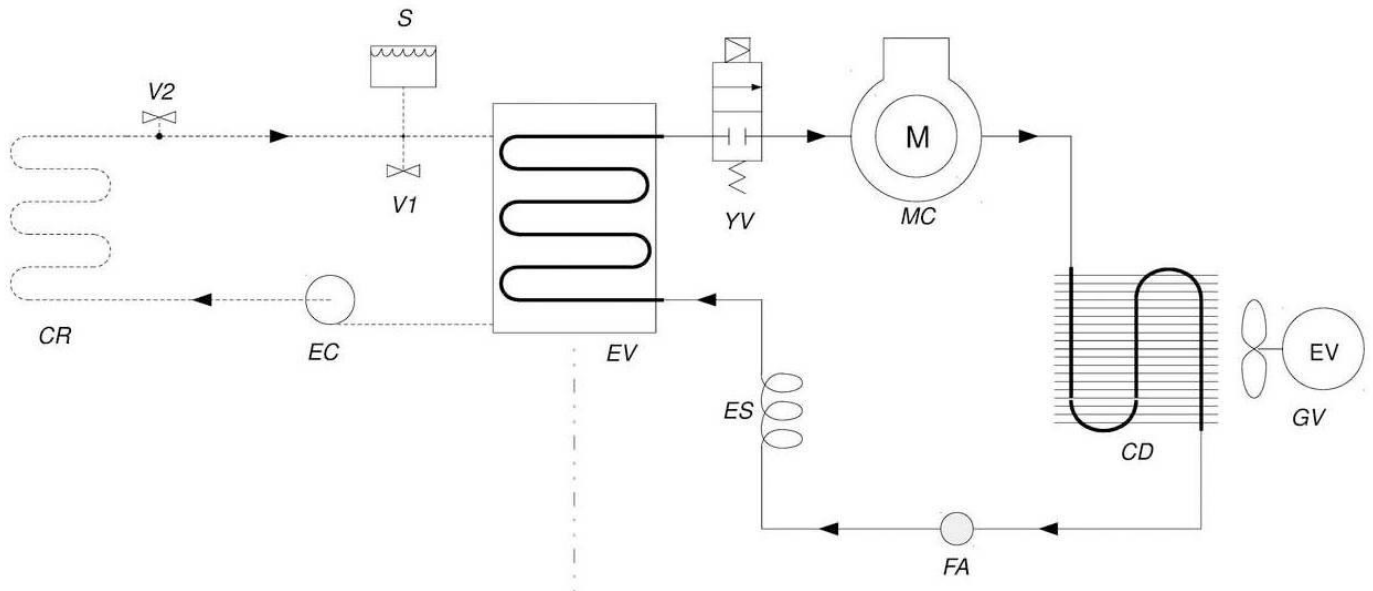









Secondary circuit	
EC	Electro circulator
V1	Emptying valve
V2	Purging valve
S	Reservoir
CR	Cooling manifold

Primary circuit	
MC	Motor-compressor
CD	Condenser
GV	Ventilation system
FA	Oil separator filter
ES	Expansion valve
EV	Evaporator
YV	Electrovalve











8. Spare Parts Section

	ONE 001 Transformer 220 V - 24 V
	ONE 002 Fridge group solenoid
	ONE 003 Power board
	ONE 004 Display and control card
	ONE 005 Display Membrane
	ONE 006 Tank sensor 6x100 wire length 2m
	ONE 007 Column sensor 6x60 wire length 1m
	ONE 008 Terminal sensor 6x100 wire length 1m
	ONE 009 Fridge sensor 6x150 wire length 2m

	ONE 010 Flap for accessories' socket
	ONE 011 Connecting cable between microcircuit board and power board
	ONE 012 24V tungsten resistance for vibrating table
	ONE 013 Safety relay
	ONE 014 Line contactor
	ONE 015 24V accessory socket
	ONE 016 230V accessory plug
	ONE 017 230V accessory plug
	ONE 018 24V accessory plug



	ONE 019 Electrical panel door microswitch		ONE 028 Motor for vibrating table
	ONE 020 Emergency button box		ONE 029 Spring for vibrating table
	ONE 021 Emergency button		ONE 030 Mat for vibrating table
	ONE 022 Pedal		ONE 031 Vibrating table wiper
	ONE 023 Fuse kit		ONE 032 Nut-gasket for fixing resistance to vibrating table
	ONE 024 Column resistance		ONE 033 Vibrating table sliders
	ONE 025 Tank-bed resistances		ONE 034 Tank mixer motor
	ONE 026 Tank sides band resistance		ONE 035 Pump motor
	ONE 027 Junction box for vibrating table		ONE 036 Tank mixer reducer

	ONE 037 Pump reducer
	ONE 038 Reducer driveshaft
	ONE 039 Tank mixer
	ONE 040 Tank pump duct cast
	ONE 041 Mixer Teflon bushing
	ONE 042 Flange attachment tank reducer
	ONE 043 Pump attachment flange
	ONE 044 H ₂ O circulation pump
	ONE 045 H ₂ O pump coupling

	ONE 046 Flexible tube for tank pump
	ONE 047 H ₂ O tubing kit
	ONE 048 Tap for H ₂ O
	ONE 049 Sensor holder
	ONE 050 Column thermal insulation
	ONE 051 H ₂ O tubing connections kit
	ONE 052 H ₂ O tank air exit hole
	ONE 053 Chocolate discharge valve
	ONE 054 Hydraulic block for pump fixing



	ONE 055 Fast accessories attachment
	ONE 056 Compressor starter box
	ONE 057 Condenser cooling fan
	ONE 058 Fridge compressor
	ONE 059 Fridge condensor
	ONE 060 Fan grating
	ONE 061 Mechanical pivot wheel
	ONE 062 Tank protection grid
	ONE 063 Nozze for chocolate supply

	ONE 065 Tank cover
--	------------------------------