

RS200

USER AND SERVICE MANUAL



PREFACE

SELM S.r.l. would like to thank you for purchasing our "RS200" Coating machine.

This manual is to be considered an integral part of the machine and its purpose is to allow use of the machine throughout its life, from delivery until demolition. Therefore, we suggest that you read it carefully. Everyone working with the machine must read this manual. It is also necessary to keep the manual in a place accessible to operators at all times.

In the event of loss or damage of this manual, please ask SELMI S.r.l. to send you a replacement copy.

The technical information contained in this manual belongs to SELMI S.r.l. and must be considered proprietary.

The total or partial reproduction of the graphic design, text and illustrations is forbidden

With a view to constant technical improvement, the company reserves the right to make any necessary amendments to the content of the manual, to the machine or to parts thereof. Consequently, some of the illustrations may differ slightly from your machine.

This document is an integral part of the "RS200 Coating machine", as described in section 1.7.4 of annex I of directive 2006/42/EC.

The Italian edition of this manual contains the original instructions. The foreign language editions are to be considered as translations of the original instructions.

© Copyright SELMI S.r.l.
Edition February 2019

EC DECLARATION OF CONFORMITY



The manufacturing company SELMI S.r.l., with main office in S. Vittoria D'Alba (CN) Italy – Via Statale, 151, in its capacity as manufacturer, declares, under its own responsibility, that the machine named:

RS200 - Coating machine

Serial number:

is compliant with all the provisions contained in the following directives: 2006/42/EC (machine directive), 2014/30/UE (electromagnetic compatibility) 2014/35/UE (low voltage directive) and EC regulation 1935/2004 (contact with foodstuffs).

The norms adhered to that are used as a reference for the design, realization and testing of the machine are listed in the technical files archived at Selmi Srl.

The manufacturer also wishes to inform you that the technical file may, in the cases envisaged by the directive, be put together by the manufacturing company.

Year of construction



The liable person

Date

Index

1. General information	5	3. Moving and transportation section	18
1.1. Structure of the manual	5	3.1. General norms	18
1.2. Messages Used	5	3.2. Packaging	18
1.3. Aim and contents	5	3.3. Transportation	19
1.4. Preservation of the manual	5	3.4. Removal of the packaging	19
1.5. External components	5	4. Installation section	20
1.7. Details of the manufacturer	9	4.1. Positioning	20
1.8. Identification plate of the machine	9	4.2. Electrical connections	20
1.9. Identification plate of the CE marking	9	4.3. Commissioning	20
1.10. Inteded use	9	4.4. Installation of the machine	21
1.11. Operating environment	9	5. Operation section	25
1.12. Noise level	9	5.1. Description of the controls	25
1.13. Technical characteristics	10	5.2. Machine adjustment	26
1.14. Dimensions	10	5.3. Using the machine	27
1.15. Storage	11	5.4. Position of the user	29
1.16. Disposal	11	5.5. Involuntary electrical interruptions	29
1.17. Warranty	11	6. Maintenance section	30
1.18. Person qualified to operate	12	6.1. General information	30
2. Safety section	13	6.2. General safety practice	30
2.1. Safety information	13	6.3. Cleaning external parts	31
2.2. Safety limitations	13	6.4. Maintenance of mechanical parts	31
2.3. Safety symbols and plaques	14	6.5. Maintenance of electrical system	32
2.4. Safety and protection devices	14	6.6. Components subject to wear and tear	32
2.5. Client's safety measures	16	6.7. Planned preventive maintenance	33
2.6. Personal protection equipment	16	7. Technical diagrams section	40
2.7. Residual risks	16	7.1. Electrical circuit diagram	40
2.8. Applied Directives	17	8. Spare Parts Section	42
2.9. Harmonized technical norms	17		

1. General information

1.1. Structure of the manual

To simplify the reading and understanding of the information contained in this manual and to make searches quicker, it has been divided into sections, each dedicated to a specific subject.

1.2. Messages used

Attention

This type of message is used to draw the reader's attention to more delicate or particular procedures which, if not carried out correctly, may pose a risk to the safety of the operator and cause damage to parts of the machine.

Warning

This type of message is used to draw the reader's attention to procedures which, if not carried out correctly or at pre-set intervals, may cause damage to the machine or its parts, as well as to the product being processed.

Environment

Messages relating to the environment draw the operator's attention to the rules to be followed to prevent the risk of environmental damages deriving, directly or indirectly, from use of the machine.

Note

These messages highlight instructions, advice and notes that can be particularly helpful during the various uses of the machine.

1.3. Aim and contents

This manual has been drawn up in consideration of the requirements of directive 2006/42/EC and paying particular attention to describing all the procedures necessary to obtain the best working conditions for the machine and its operators, without neglecting product quality:

The aim of this manual is, therefore, to provide the user with all the information necessary for the correct use and maintenance of the machine. Consequently it is absolutely necessary:

- to meticulously follow the instructions given in the manual during every phase of the machine's life, from transportation to demolition;
- for every machine operator to thoroughly read the contents of this manual;
- for the company's safety officer to make sure that all machine operators have clearly understood how the machine works

Attention

In case of doubts on the correct interpretation of the instructions please contact the manufacturer to obtain the necessary clarifications. All those carrying out any kind of operation on the machine must have thoroughly read and understood the contents of this instruction manual.

Warning

If this manual is damaged or lost, please ask the manufacturer or the authorised distributor in the country where the machine is being used for another copy.

1.4. Preservation of the manual

The instruction manual is an integral part of the machine and must be used to train and inform professional figures operating on the machine. Consequently, it is necessary to follow certain simple instructions regarding its preservation, as follows:

- store the manual in areas protected from humidity and heat, so as not to jeopardise the quality or legibility of any part of the publication;
- keep the manual in an easily accessible place known to the machine operators;
- avoid handling the manual with dirty or greasy hands;
- if you think it is necessary to highlight important steps of the manual, use non-permanent systems, to preserve its legibility;
- do not remove, rip or rewrite any parts of the manual for any reason.

1.5. External and internal components

- 1 Command panel
- 2 Emergency button
- 3 Lock / Unlock lever for paper roll
- 4 Paper roll
- 5 Blower
- 6 Stand
- 7 Belt
- 8 Chocolate emitting tube
- 9 Air emitter
- 10 Chocolate emitter
- 11 Coating section mesh
- 12 Loading section mesh
- 13 Crumbs collector
- 14 General safety switch
- 15 Transmission chain
- 16 Board
- 17 Inverter
- 18 Inverter
- 19 Microswitch
- 20 Motor
- 21 Gear motor
- 22 Tail cutting roller

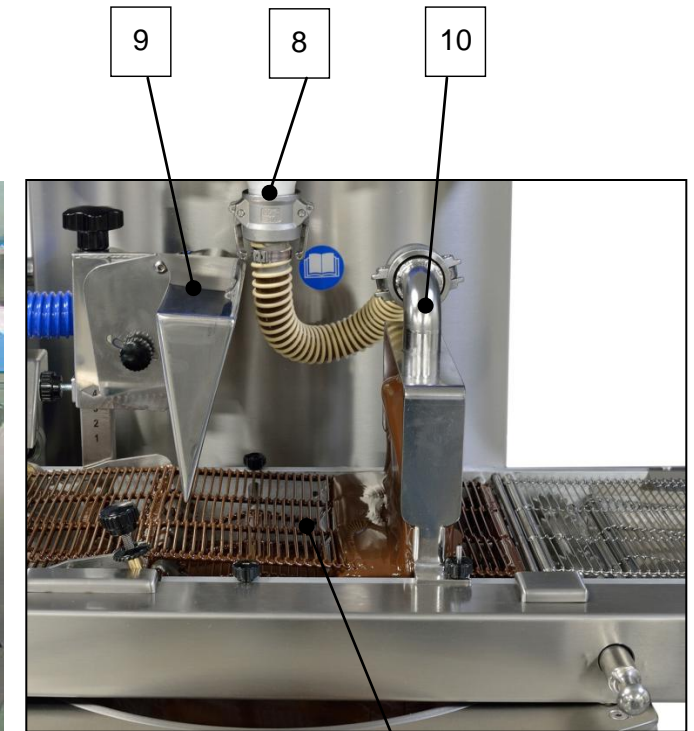
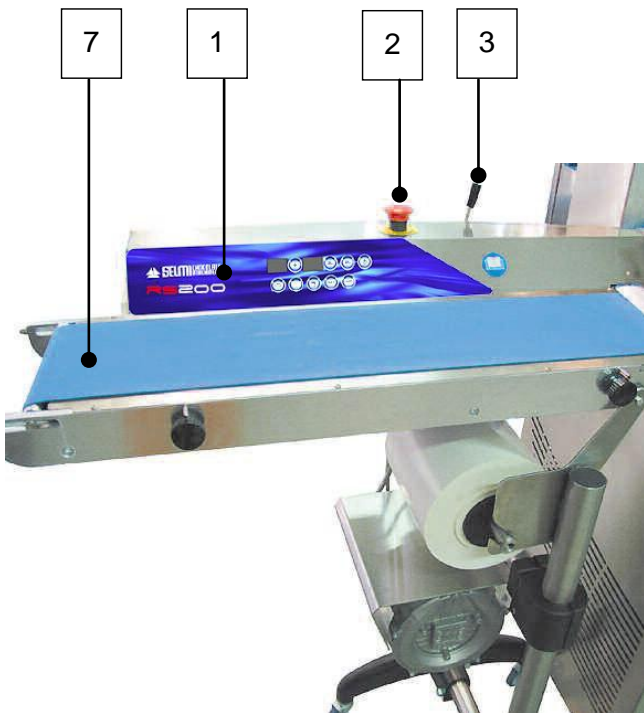
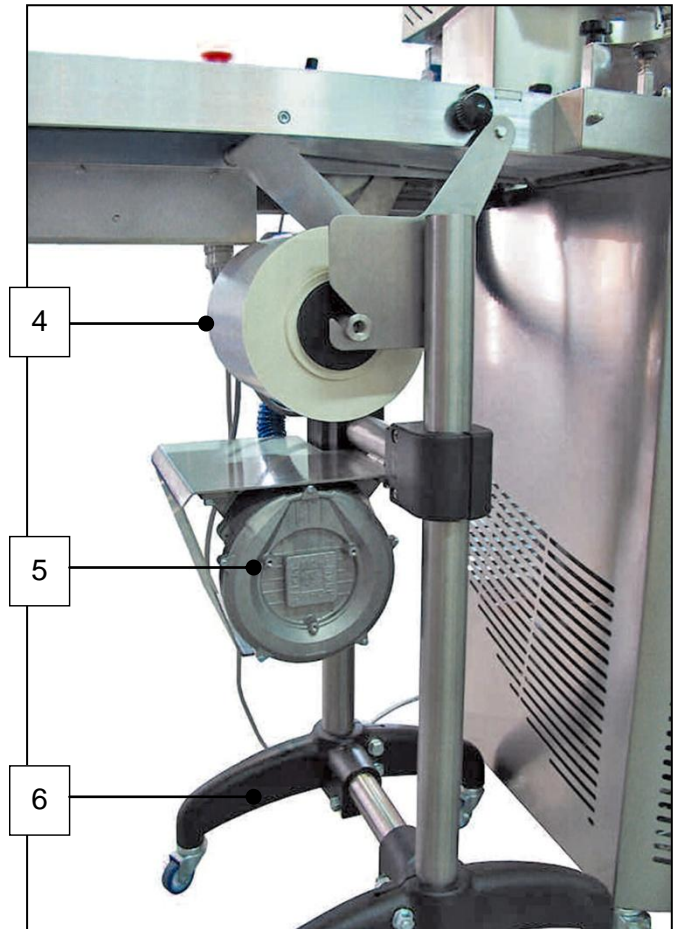



12 13

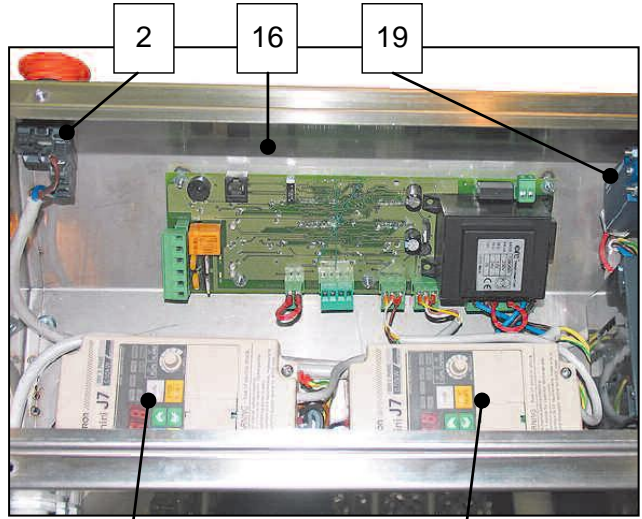

2 16 19
17 14 18

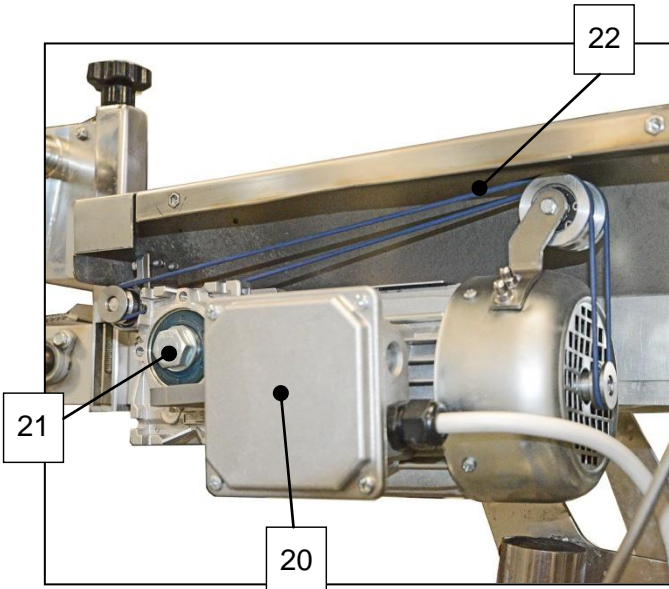

21 20 22



14

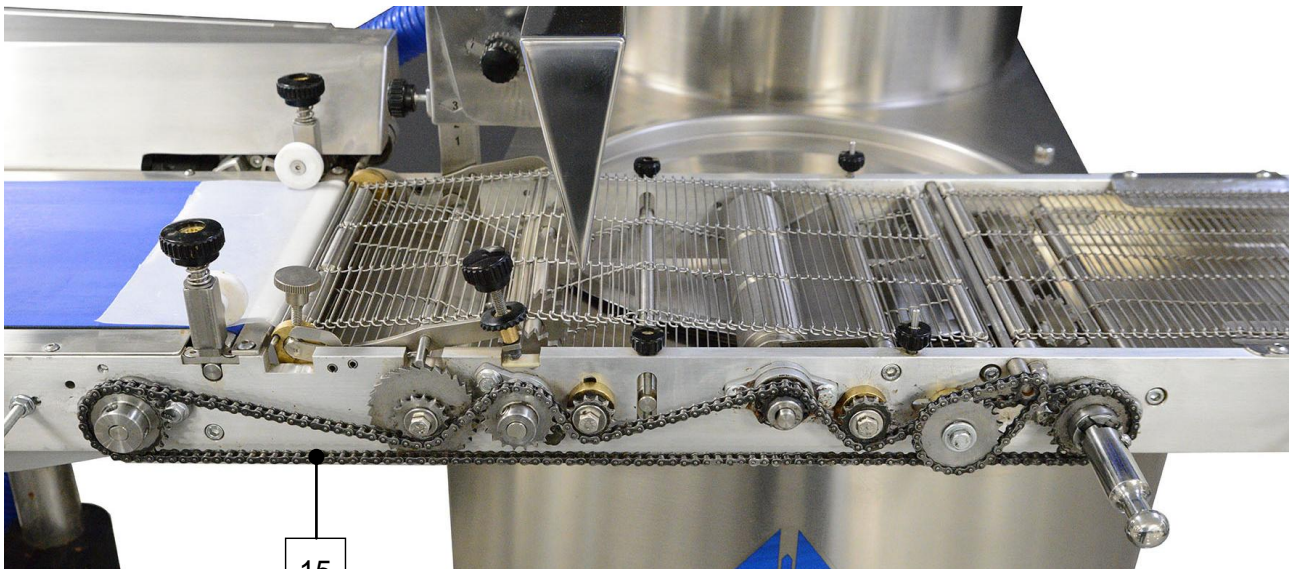

15

Power board

1. Auxiliary 24V
2. Programming input
3. Supply 220V
4. Connection for blower inverter
5. Connection for belt motor inverter
6. Connection for sensors
7. Auxiliary digital input
8. Connection for auxiliary triacs

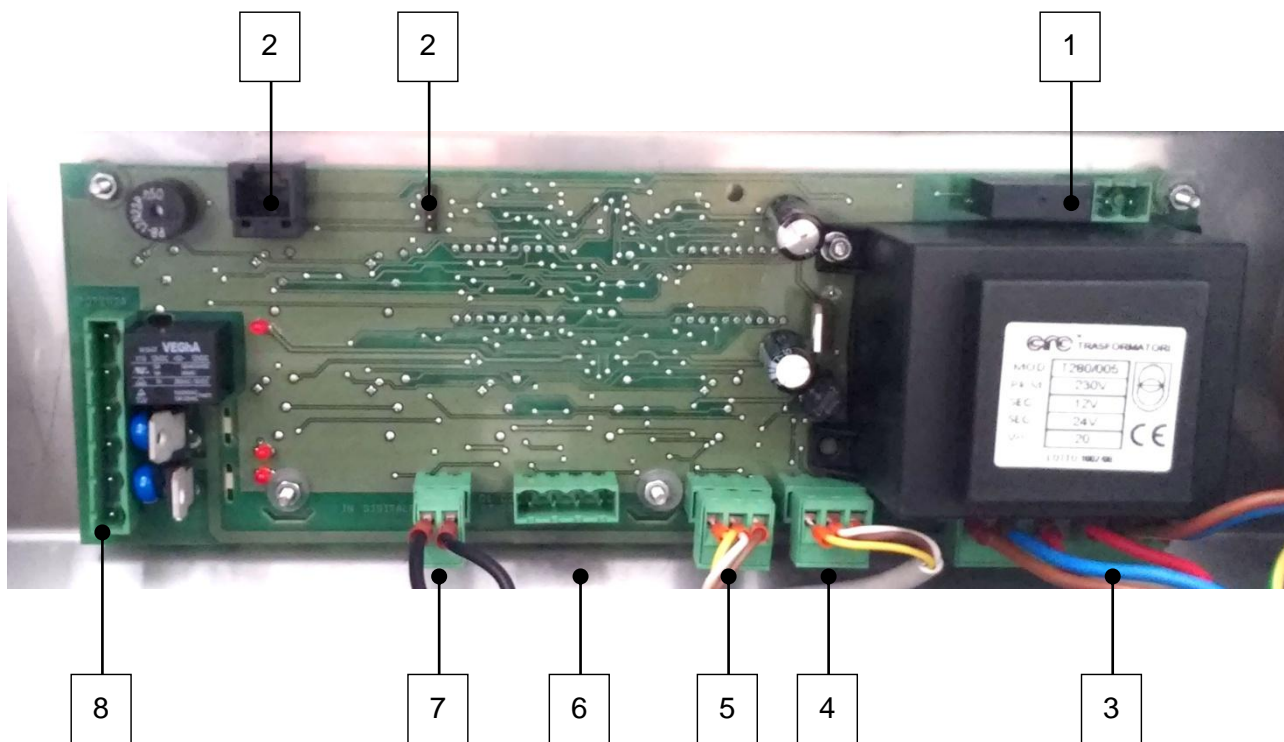

1.7. Details of the manufacturer

The machine described in this instruction manual was built by:

SELMI S.r.l.

Via Statale, 151 – 12069 – S. Vittoria D'Alba (CN) Italia
 Tel. 0172.479273 - 0172.479275 - Fax 0172.477814
 www.selmi-group.it - info@selmi-group.it

1.8. Identification plate of the machine (CE marketing)

There is a plate, similar to the one shown here, on the machine, indicating details of the manufacturer, the CE conformity mark and the machine's serial number. Always state this number when communicating with the manufacturer.



Example of identification plate on the machine structure

TYPE
SERIAL NUMBER
YEAR
WEIGHT

1.9. Identification plate of the CE marking electric panel (low voltage)

Example of identification plate on electrical panel. For the correct data, see the data shown in the section on the machine's technical specifications.



1.10. Inteded use

This machine was specifically designed and built to coat various types of sweets with chocolate.

The RS200 coating machine must only be used with tempering machines (Plus EX, Top EX and Futura EX) built by Selmi Srl.

The RS200 coating machine will only work properly when attached with the appropriate locks to the Selmi tempering machines.

For the correct use of the machine continuous processing is recommended.

Warning

A use other than that specified is considered improper. The machine is intended for professional use only.

Attention

Do not place any small objects near the control panel or the tank: they could fall and enter the tank, which would contaminate the product.

1.11. Operating environment

To guarantee proper functioning the machine must be protected from atmospheric agents. Its ambient operational temperature should be between 15C° and 35C° with relative humidity not exceeding 70%.

The working environment must be clean, sufficiently illuminated and away from an explosive environment. The environmental characteristics of the installation site are specified in section 4.

Attention

The machine's fixed guards have a variety of openings to allow the internal units to cool. When the machine is running, make sure that these openings are not covered by cloths or objects that obstruct proper air flow.

1.12. Noise level

The phonometric tests carried out on this specific machine model show an acoustic pressure lower than **70 dB(A)**.

1.13. Technical characteristics

Mechanical characteristics

Motors	Asynchronous triphase 0,18 kW
Reducers	Motovario NMRV 030
Steel	AISI 304
Blower	kW 0,1
Aluminium	Anticorodal
Conveyor belt	Alimentary PVC
Total weight	85 Kg

Electrical characteristics

Power consumption:	0,5 kW
Power supply voltage:	230V
Phases:	1
Frequency:	50Hz or 60Hz*
Wrapping protection:	IP65

* This data can change according to the contractual installation conditions. For correct data refer to the plate inserted inside the electric panel.

1.14. Dimensions

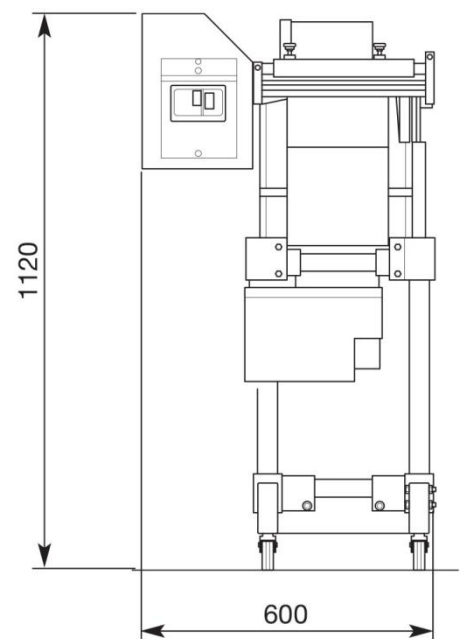
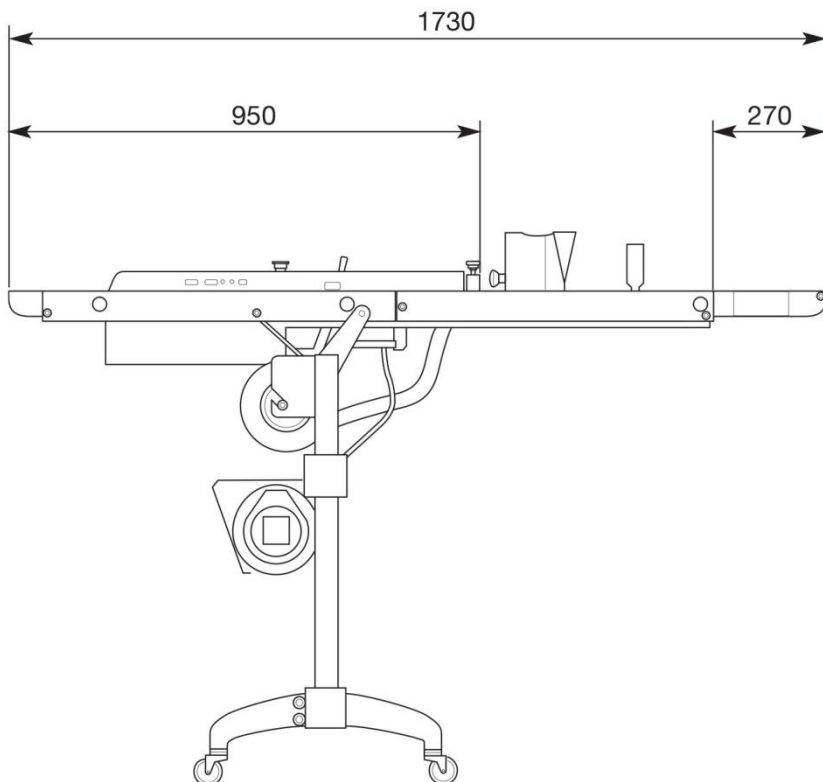

1.15. Storage

Remove the remaining product left in the machine following the instructions in the appropriate section. Stop the machine using the main switch and disconnect it from the electricity main. Move it to a spacious place (it is necessary to work all around the machine).

Clean the tank, the removable components (i.e. screw pump, mixer, nozzle) and the pipes as described in the appropriate section.

Attention

It is absolutely necessary to follow the instructions in order to insure the safety of the operators and to avoid damaging the machine's removable parts.

Use a brush to cover the movable components and the mechanical moving parts with a thin layer of food grade lubricant. This can later be removed with an alkaline de-greaser (Sodium Hydroxide) if the machine needs to be re-installed.

Carry out the same operation on the machine surfaces, taking care of avoiding the heating elements located in the inner part of the machine.

Gather the parts (use as reference the delivery packing list) and put them in the original packaging. Place packets of hygroscopic salt based on silica gel in the packaging.

Store all the parts in a sheltered place away from atmospheric agents and in temperatures from 0° C to 40° C. Cover the parts with nylon in order to prevent the accumulation of dust.

1.16. Disposal

Disposal will occur at the end of the working life of the machine, which under normal conditions of use and maintenance will be over ten years.

In the case of disposal all the components of the machine will have to be disposed of in adequate waste yards according to the legislation in force.

Before disposal it will be necessary to separate the plastic or rubber parts and the electrical and electronic material.

Environment

Parts made solely of plastic, aluminium and steel can be recycled in the appropriate collection centres.

According to the RoHS regulations electronic boards and electric material should be recycled separately in authorised collection centres.

1.17. Warranty

The manufacturer offers a warranty on this machine model for a period of 24 months from the purchase date, as shown on the fiscal document issued at the time the machine is delivered.

The warranty will be void if the machine is repaired by a third non authorized party or if fixtures and accessories not supplied by or recommended or approved by the manufacturer are used.

The warranty will also be void upon removal or alteration of the plate showing the serial number and other data.

Within the warranty period the manufacturer will repair or replace, free of charge, parts that are faulty due to manufacturing.

In case the repair has to take place at the manufacturer's site, the machine will have to be sent to the manufacturer in its original packaging.

Transportation expenses will be covered by the manufacturer during the warranty period.

The warranty does not cover the cleaning of the functioning parts.

Defects not clearly attributed to the material or the manufacturing will be examined. If the claim should turn out to be unjustified all repair expenses, changed parts and transportation will be charged to the buyer.

The warranty does not cover damage caused by the following:

- accidental damage during transportation
- damage due to lack of care or procedures carried out incorrectly
- damage due to improper use not conforming to the warnings of the user and service manual
- components subject to wear and tear; a detailed list is available in the components section.

Structural damage, modifications, improper alterations or repairs can affect the functioning of the safety mechanisms, thus making the declaration of conformity and warranty void. Alterations on the machine can be carried out solely by technicians authorised by the manufacturer.

1.18. Professional personnel qualified to operate the machine

The machine must only be used by authorised and purposely trained personnel; the same precautions are also applicable to personnel who carry out maintenance.

Personnel who do routine and extraordinary maintenance must be specially trained professionals; good knowledge of the machine is needed for extraordinary maintenance.

Attention

Do not permit others to approach the machine during its use or maintenance.

The following professional people, after having received all the necessary instructions, are the only ones allowed access to the machine:

Safety officer

The safety officer is responsible for protection and prevention of risks in the workplace, as is mentioned in European Directive 89/391/EEC (Safety in the workplace), introduced in Italy with the 12/11/1994 Legislative Decree.

It is the responsibility of the safety officer to make sure that all personnel who use/maintain the machine have received all the instructions regarding their relative roles contained in this manual.

Operator (user of the machine)

Operator trained and qualified for the use of the machine (working cycle, potential adjustments, etc.). He/she can only carry out the specific tasks described in this manual reserved for this role.

Mechanical maintenance technician

The technician is qualified to use the machine as the OPERATOR and furthermore to use it with the protection disabled, to attend to the mechanical parts for adjustments, maintenance and reparations.

He/she is not qualified to act on live electrical installations.

The mechanical maintenance technician must have a generic knowledge of the machine and a specific knowledge on this machine model.

Electrical maintenance technician

The technician is qualified to use the machine as the OPERATOR and furthermore to use it with the protection disabled, to attend to the adjustments and electrical installations for the purposes of maintenance and repair.

If qualified, he/she may work when the electrical panels, control devices, are live, provided he/she uses appropriate personal protective devices.

The electrical maintenance technician must have a generic understanding of the electrical panels and specific knowledge on the electrical panel and components of this machine.

Manufacturer

The manufacturer's personnel are qualified to perform all of the above-described operations.

Any operations not described in this manual may be performed ONLY by personnel authorized by the manufacturer.

2. Safety section

2.1. Safety information

Attention

The safety officer has the obligation to inform the workers on the risks related to the use of the machine.

Furthermore the employer must inform, educate and train the user according to statutory laws.

The lack of compliance with the basic norms or precautions could result in accidents during the functioning, maintenance or reparations of the machine. Accidents can often be avoided by acknowledging potential hazardous situations before they materialise. The operator must pay attention to the potential dangers and have the training, the competence and the necessary equipment to deal with these tasks correctly.

The manufacturer cannot be held responsible for accidents or damages resulting from the use of the machine by personnel not adequately trained or having used the machine improperly, as well as the lack of, even partial, compliance to the safety norms and interventions procedures contained in this manual.

The safety precautions and the warnings messages, the operator could be subject to accidents with serious consequences for himself and for other people.

In cases where tools, procedures, work methods or working techniques not explicitly suggested by the manufacturer are used, it will be necessary to make sure that no dangers are present for the individual carrying them out and to other alike.



Use exclusively original SELMI spare parts. The manufacturer will take no responsibility for accidents or damages in the case of use of non-original spare parts.

If a tool not supplied by the manufacturer is installed on the machine, the client needs to make sure that the norms stated in Directive 2006/42/EC are adhered to. If this new tool introduces new risks to the system then the new system must be re-certified. In any case the manufacturer cannot be held responsible for accidents or damages caused by the machine if it has been modified or equipped with non original accessories.

2.2. Safety limitations

Attention

The indications mentioned hereafter cannot completely safeguard from all dangers that one might encounter while using the machine; they must be used in conjunction with common sense and the experience of the operator, the only indispensable measures for the prevention of injury.

Every section has a list of specific safety measures for different operations. The safety measures mentioned here below are generic and should be followed for all procedures on the machine.

The responsibilities assigned to specific people concerning the use of the machine must be clearly defined as stated in the "Qualified Personnel" section.

Attention

The use of the machine is forbidden to personnel who have not been authorised or trained by the safety officer.

Consult the manufacturer before carrying out procedures that are not mentioned in this manual.

Prolonged overloads or anomalies can cause the electric motors and electrical appliances to overheat with resultant harmful fumes. In such cases immediately disconnect the machine from the mains and do not approach the machine until such fumes have been dispersed via adequate ventilation. In case of fires do not use water jets on the machine – use CO2 extinguishers instead.

The operator, any helping technician and the maintenance technician must use the appropriate personal protection equipment when working on the machine.

It is forbidden to climb on the machine.

Do not touch the electrical wires, switches, buttons etc. with wet hands.

The parts subject to wear and tear during the functioning of the machine must be checked and replaced as soon as they present noticeable signs of wear and tear.

The manufacturer has designed and built the machine to last for a reasonable time with the Client's normal conditions of use in mind; it is however necessary to periodically check the components and the structure of the machine, paying attention to any anomalous conditions, such as, for example, cracks or deformations. If necessary, contact the manufacturer to ask for a complete check of the machine.

Please consult Section 4 (Installation) for the working environmental conditions of the machine.

2.3. Safety symbols and plaques

The machine has a number of plaques with symbols and and/or safety messages stuck to it.

Attention

Make sure that all the safety messages are legible and in good condition.

Replace the damaged plaques with the new ones from the manufacturer. If a plaque happens to be on a part that is being replaced, make sure that a plaque is present on the new piece. For the cleaning of the plaques consult the appropriate section (6.3).

ATTENTION

THE PERFORMANCE OF WORK ON ELECTRICAL EQUIPMENT CONNECTED TO THE POWER SUPPLY IS STRICTLY FORBIDDEN

- ANY EXCEPTIONS MUST BE AUTHORISED BY THE EXECUTIVE MANAGER
- IN PARTICULARLY DANGEROUS SITUATIONS, ANOTHER PERSON MUST BE PRESENT IN ADDITION TO THE PERSON PERFORMING THE WORK

WORK MAY ONLY BEGIN WHEN THE SAFETY MEASURES HAVE BEEN IMPLEMENTED

IN OBSERVANCE OF PRESIDENTIAL DECREE 543 ON THE PREVENTION OF ACCIDENTS



(positioned on the door of the electrical panel)



Label indicating compulsory reading of the manual
(positioned on the front of the machine)

2.4. Safety and protection devices

Attention

The components shown here are particularly important for the safety of the operator and the machine. In cases of malfunction or wear they must be replaced with spare parts supplied or authorized by the manufacturer.

While the machine is in use all the protection devices must be correctly installed.

The safety devices present on the machine are:

- *Mushroom emergency button with mechanical unblock mechanism.*

There is an emergency stop mushroom button on the machine. Pushing it cuts voltage to all live parts by means of appropriate devices.

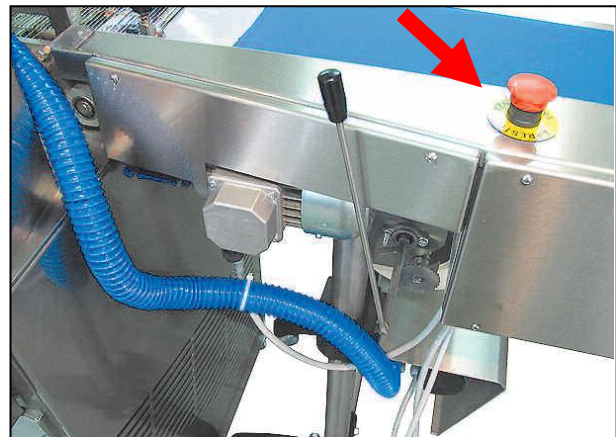

To reset it, release the emergency button by turning its head and then push the RESET button shown in the photo.

Before starting every shift, press it to make sure that it works properly.



- *Electric panel safety microswitch*

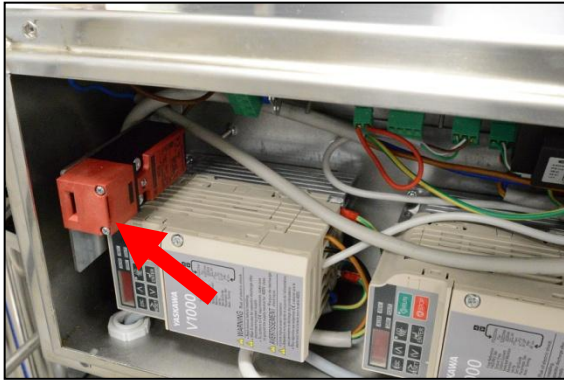

Within the electrical panel there is a safety microswitch which disconnects the voltage every time the panel is opened for maintenance interventions.

Attention

Periodically check that the safety microswitch is working properly. If faulty, please proceed immediately with its replacement.

- *Fuses*

The following fuses are located within the electric panel on the power board:



Warning

If fuses keep blowing it may be an indication of a fault of the devices installed on the machine; in such cases contact Technical Support.

- *Protective devices*

The machine is equipped with protective plates (A) that can be removed with a tool to allow access to the inside of the machine in order to carry out maintenance operations.

The fixed protective plates are screwed into position and can be removed with the appropriate tool; if the screws are removed the fixed protective plates will not remain in place and must be placed on the floor.

All the protective plates have smoothed and rounded edges for the safety of the exposed individual and of the operators.

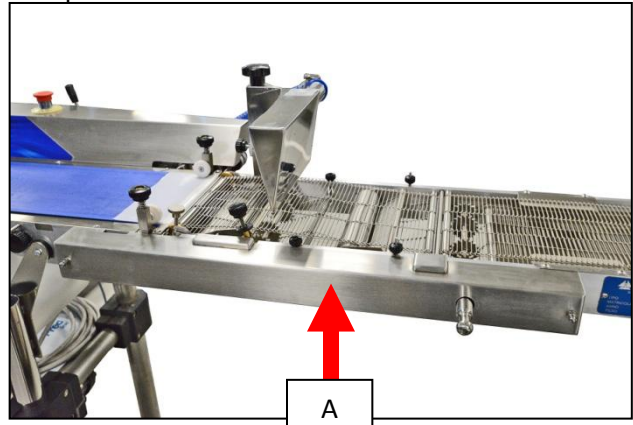

Attention

Do not switch the machine on if the protective panels are removed or not correctly fixed into position with the appropriate screws. Do not forget to remove cloths, keys or utensils used for the maintenance operation from within the machine.

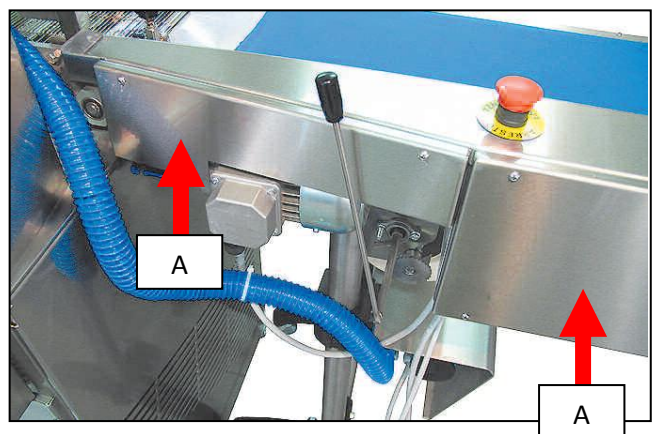

2.5. Client's safety measures

The client must arrange for the following safety measures to be in places:

Provision of an adequate location for installation, paying particular attention to the characteristics below:

- Adequate flooring
- Normal and emergency lighting
- Adequate ventilation
- Clearly signposted emergency exits
- Provision of mains voltage connection with associated safety devices, conforming with the norms in force and the characteristics of the machine
- Adequate means for the collection and subsequent disposal of residues, even hazardous or special ones (oils and grease, broken or waste material, etc.).
- Adequate fire safety systems and equipment
- Prohibition of entry into the installation area to non authorized personnel

The customer must also provide for:

- Training of the operators and the maintenance technicians
- Training for the operators on the basic functioning of the machine and emergency devices
- Provision of personal safety equipment to protect the operator and the hygiene of the product
- Checking the qualifications of external maintenance technicians potentially called to work on the machine
- Keeping of a maintenance log book

The employer is also responsible for checking that the operators correctly carry out the procedures explained in this manual.

2.6. Personal protection equipment

The operators who carry out functions on the machine must receive appropriate instructions on the use of personal protection equipment such as shoes, gloves, etc... which will protect them from residual risks derived from the execution of various activities. The operators must furthermore be equipped with protection equipment for hygiene purposes (caps or hair nets, gown, etc...).

If the noise level in the working environment surpasses 85dB(A) appropriate ear protection must be used.

Warning

The clothing of whoever operates or carries out maintenance on the machine must conform to the essential safety requirements defined by European directive and the laws in force in the country in which the machine is installed.

Attention

During maintenance operations individuals must wear adequate clothing to prevent the occurrence of accidents.

In order to avoid mechanical risks such as snagging or dragging, it is prohibited to wear particular objects such as bracelets, watches, rings or necklaces during the working cycle and during maintenance operations.

2.7. Residual risks

The accurate risk analysis carried out by the manufacturer and archived in the technical file has eliminated most of the residual risks, which are nevertheless present during the use of the machine, to acceptable levels.

The manufacturer's recommendation is to meticulously adhere to the instructions, procedures and recommendations contained in this manual.

Attention

It is strictly prohibited to carry out any type of mechanical or electrical modification so as not to create added dangers and unforeseen risks.

Attention

During cleaning and maintenance operations and during the work cycle, do not allow the product inside the tank to come into contact with water or other fluids.

Attention

If the machine remains unused for long periods of time please take note of the expiry date of the product remaining inside the machine. Upon restarting the processing only insert new chocolate if the product already in the machine has not expired. If the old product has expired, proceed to empty and clean the machine before inserting the new product.

Attention

Keep the machine with the residual chocolate inside the tank in an adequate environment with temperatures ranging from 10 °C to 25 °C.

The residual risks present on the machine are:

Risks during machine transportation

It is recommended to fasten the machine, or its parts, at the dedicated locations and lift it with appropriate means to the minimum permitted height, proceed at low speeds and make sure that the people helping with the moving are at a safe distance from the moving object. Before moving the machine make sure that the passage is clear and that there are no objects placed on the machine. It is important that the means of support and transportation is controlled by a person qualified for such a role, so as to avoid unforeseen movements which may be dangerous to the people in the vicinity who are helping with the moving.

Risks of faults to the circuits of signalling, safety, protection and emergency stop

In the case of a circuit fault, the safety and signaling circuits, the anti-injury protections and the emergency stop can lose their effectiveness, therefore it is asked that their functionality is periodically checked.

Identified residual risks and information plaques

The manufacturer has placed on the machine danger and/or warning plaques, based on the residual risks, with pictograms in compliance with the norm pertaining to the display of graphic symbols on the machine. The user should immediately replace these plaques if they are not clearly legible.

Attention

It is expressly forbidden to remove the safety and/or warning plaques placed on the machine. The manufacturer will not take any responsibility on the safety of the machines if this is not observed.

Risk to life (electrolocution)

Before commencing work on any electrical appliance it is necessary to disconnect the machine from the mains. If it were to become necessary to work within the electric panel by bypassing the electricity cut off devices, then the work must be carried out exclusively by specialised personnel.

Risk of spreading fire

In case of fire never use jets of water in the vicinity of the apparatus. Disconnect all connections to the mains and use the appropriate CO2 extinguishers located in the building.

2.8. Applied Directives

The following directives apply to the machine described in this manual:

- 2006/42/EC machinery Directive
- 2014/30/UE Directive for electromagnetic compatibility
- 2014/35/UE low voltage Directive

And the regulation:

- 1935/2004 EC regulation for materials in contact with foodstuffs

2.9. Harmonized technical norms

The machine was designed and tested to conform to the “essential requirements to health and safety” present in attachment I of European Directive 2006/42/EC.

The norms used as reference for the design, the realization and the testing of the machine are listed in the technical file archived by the manufacturer.

3. Moving and transportation section

3.1. General norms

Before moving the machine always check the weight and general instructions shown on the packaging. Personnel not responsible for the movement of the machine must not remain in the area needed for movement.

3.2. Packaging

The machine is delivered on a platform, secured by means of straps and placed inside a cardboard packaging which is also secured to the platform by means of straps. An example of the machine packaging is shown in the picture below.



Instructions for transportation are on the sides of the packaging.

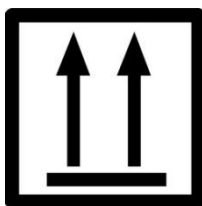

The first symbol shows the correct upright position of the packaging;



the second symbol shows that the packaging must be protected from the rain;



the third symbol shows that the content of the packaging is fragile and must be handled with care. On two sides of the packaging there is a device called "TILTWATCH", which can determine if the packaging has been tilted to such an extent that the content may have been damaged; it is necessary to pay attention to the instructions given on the adhesive label. If the machine has been excessively tilted during transportation (the dot at the centre of the TILTWATCH device will be red) some components could have been damaged.



Attention

The manufacturer's warranty does not cover damage during transportation; the buyer should follow the instructions on the adhesive label in order to avoid disputes.

3.3. Transportation

To transport the machine it is necessary to use a suitable vehicle equipped with a platform to lift the load; the platform must be adequate for the weight of the machine, which is stated in the technical characteristics section (section 1.13).

When the machine, still in its packaging, is in the body of the lorry, it can be carried to the lifting platform only by means of a manual transportation trolley for euro pallets.

The lifting platform has to be equipped with side rails in order to prevent the machine from falling when it is still high off the ground.

The machine can be lowered to the ground from the platform only after having lowered the manual trolley.

The machine should be lowered slowly from the platform, avoiding shaking and sudden stops which could cause a loss of stability.

After having completed the unloading procedures, the machine should be moved exclusively by means of a manual transportation trolley adequate for euro pallets; the platform should only be lifted to the height needed to move the machine.

Before moving the machine verify that the passage to the final destination is clear.

Attention

Do not go on very steep ramps which could cause the loss of control of the trolley.

3.4. Removal of the packaging

Cut the straps that anchor the cardboard to the platform; remove the cardboard and put it out of the way.

Cut the straps that hold the machine to the platform, remove the machine's plastic cover and unravel the accessories provided.

Carefully lift the front of the machine and remove the wooden slat blocking the front wheels; subsequently remove also the wooden slat blocking the rear wheels by lifting the back of the machine.

Very carefully lower the machine from the platform.

Note

Keep the original packaging; it may be necessary to use it if the machine needs to be sent to the manufacturer for extraordinary maintenance or repairs.

4. Installation section

4.1. Positioning

Warning

Before positioning the machine check that the machine, the associated accessories and the parts supplied separately have not been damaged during transportation.

It is the task of the Client to make sure that the strength of the supporting surface, at the point of installation, is adequate for the weight of the machine.

The flooring at the point of installation must be sufficiently level.

Isolate the machine from any potential vibrations coming from other nearby machinery.

In the case where the machine or any of the associated accessories are found damaged it is important to alert the manufacturer of the found anomaly so as to agree on the actions to be taken.

Attention

The machine must be placed on a level surface; for the other environmental requirements necessary for optimal functioning of the machine please see sections 1.11 and 2.5..

4.2. Electrical connections

Attention

The connection of the machine to the electrical system must be carried out by personnel observing the legislation in force; the characteristics of the electrical connection must be compatible with the electrical specifications of the machine which can be found in the relevant section or on the opposite plaque on the door of the electric panel.

Attention

This operation should be carried out by a technician or by a maintenance electrician.

4.3. Commissioning

Make sure that the coating machine is correctly connected to the mains.

Make sure that it is firmly attached to the tempering machine.

Make sure that there are no particular mechanical anomalies, extraneous parts in the working field of the machine and protective plates positioned improperly.

Check the safety systems: protection devices, emergency devices, control devices.

Make sure that the working area is free from potential extraneous objects to the processing and free of oil stains.

Make sure the main control panel and indicator lights are working properly and that the machine correctly responds to the commands given.

4.4. Installation of the RS200

Attach the coating machine to the tempering machine using the holes shown in the picture.

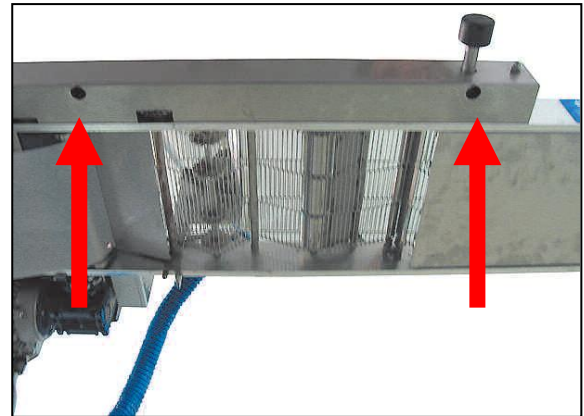

Rotate and lift the coating machine as shown in the picture.

Connect the tempering machine to the chocolate emitter of the coating machine via the provided tube (A).

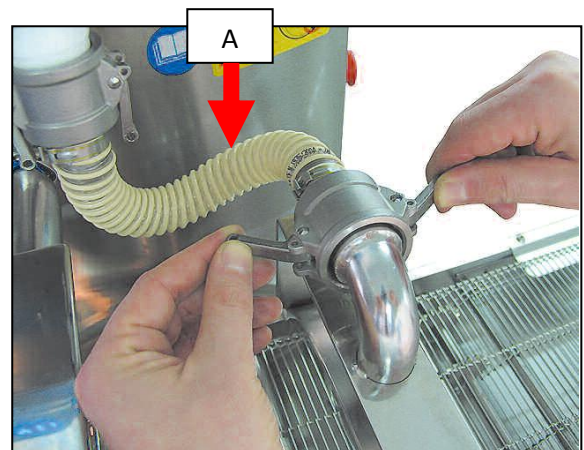

Use the knobs to pull out the shanks (B).

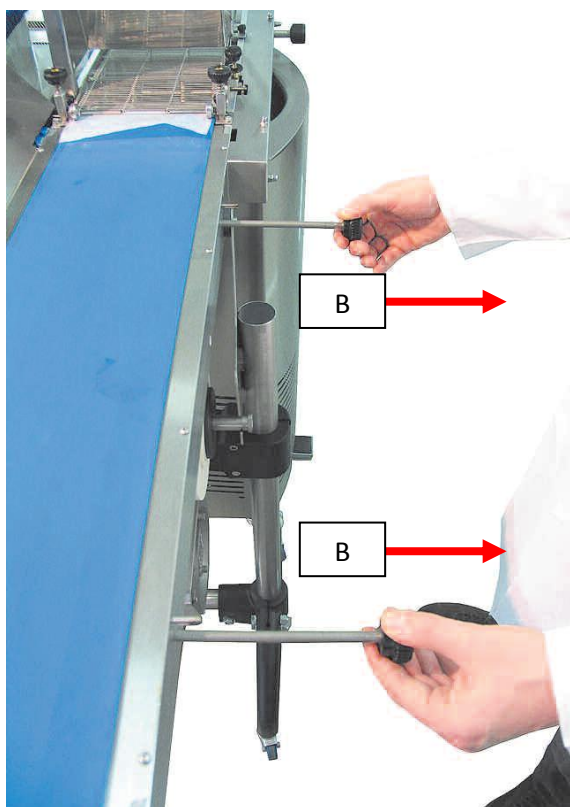

Rest the unload tray (C) on the shanks (B).

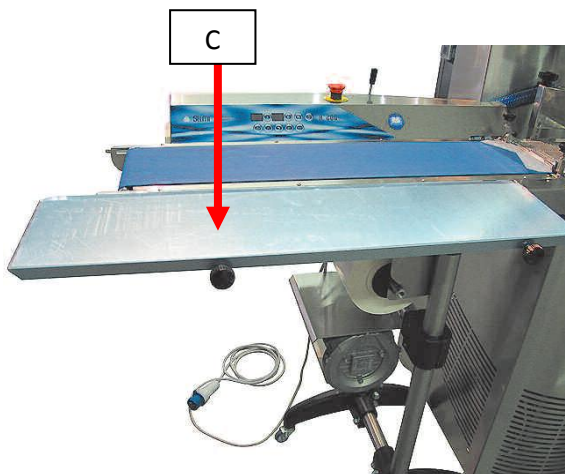

4.5. Installation of optional components

Optional "top partial coating" device

- 1) Support
- 2) Knob

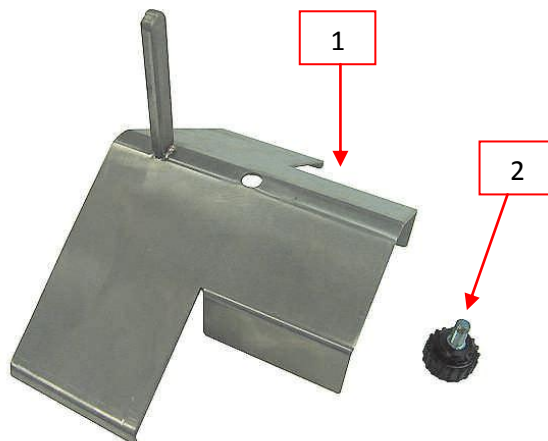

Position the support (1) under the chocolate emitter as shown in the picture.

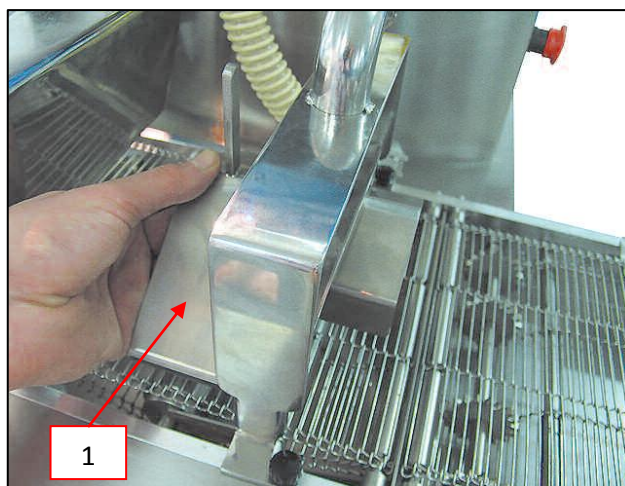

Lock support (1) in place using knob (2).

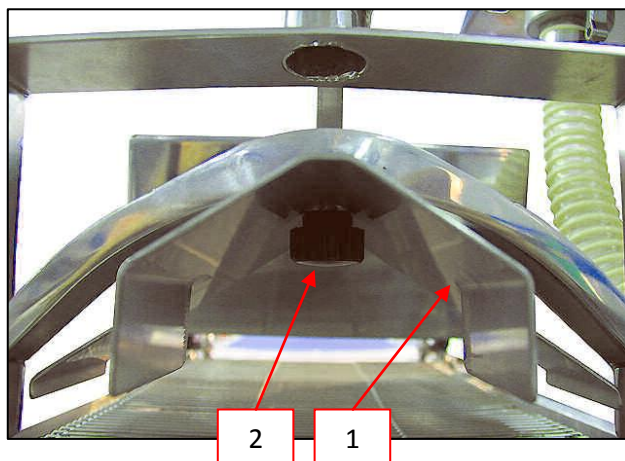

Optional “bottom partial coating” device.

- 1) Support
- 2) Support

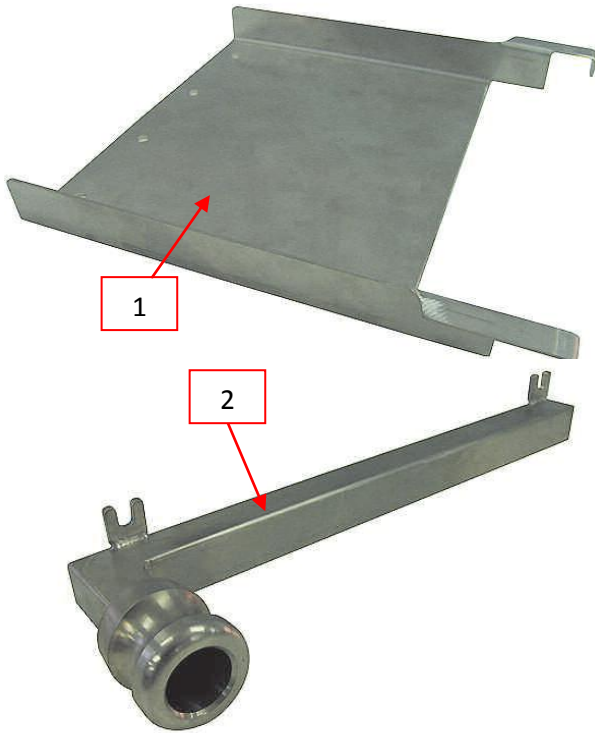

In order to install the optional device for bottom partial coating it will be necessary to remove the chocolate emitter (A) by disconnecting tube (B) and unscrewing the two knobs (C).

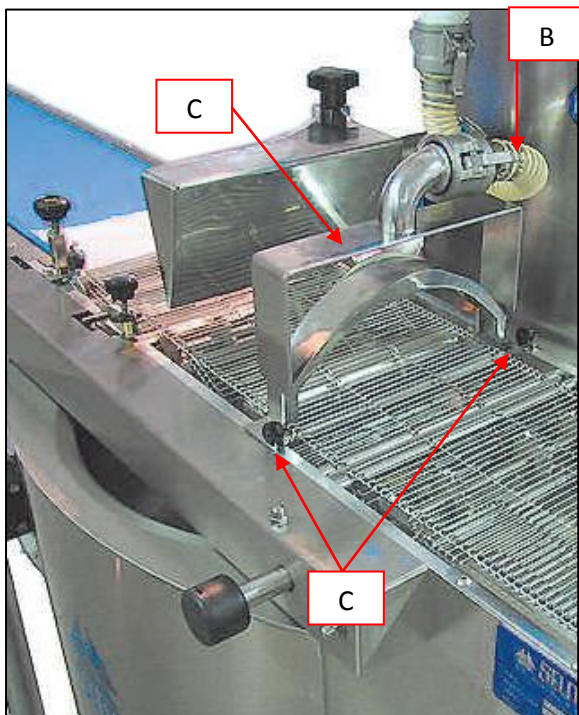

Place support (1) under mesh (D) in the coating zone.

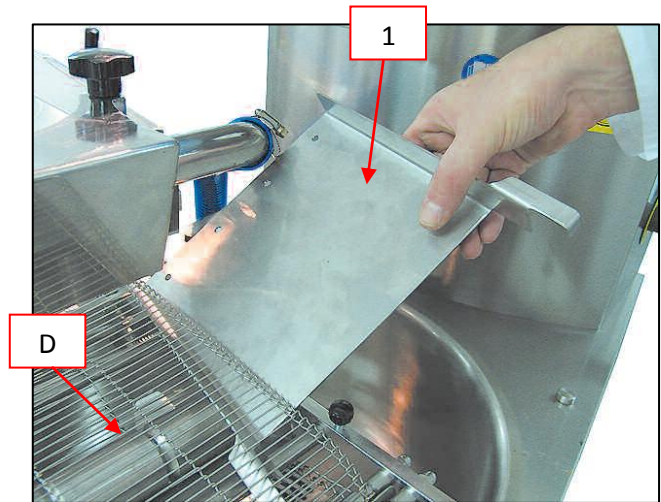

Mount support (2) and lock into place with the two locks (C).

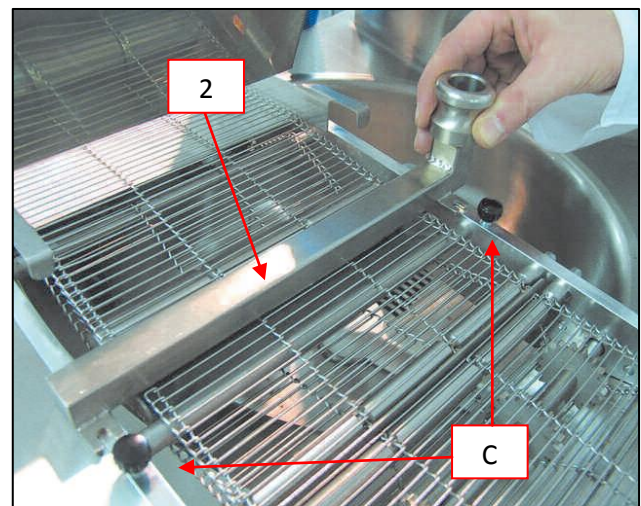

Lift support (1) and move it in the direction indicated by the arrow.

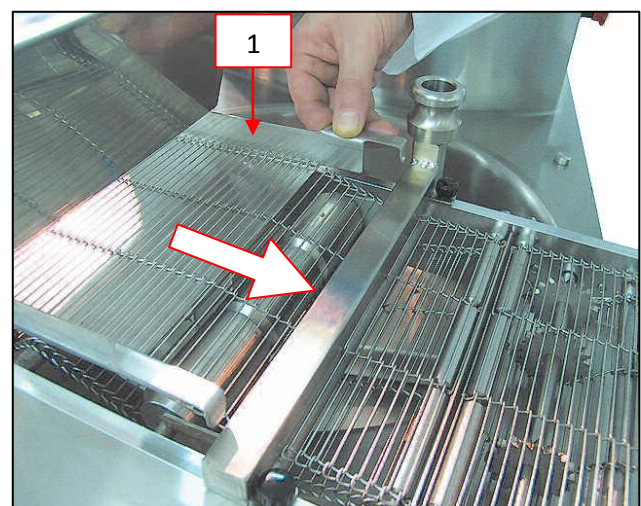

Attach support (1) to support (2) as shown in the picture.

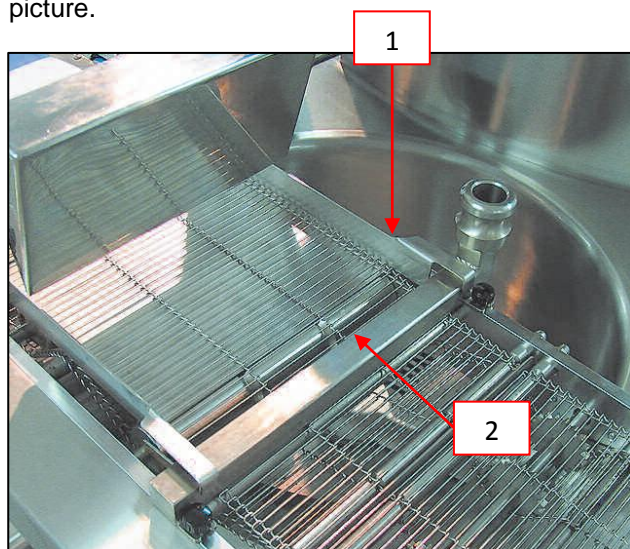



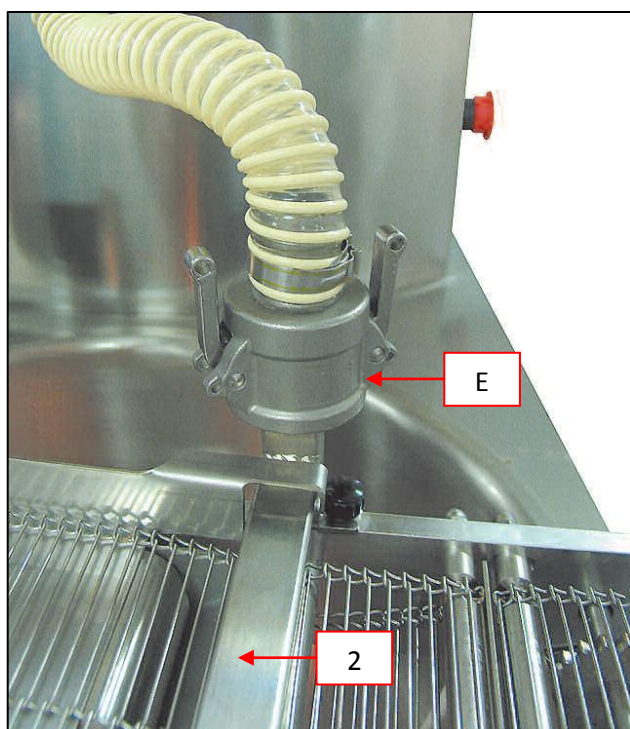





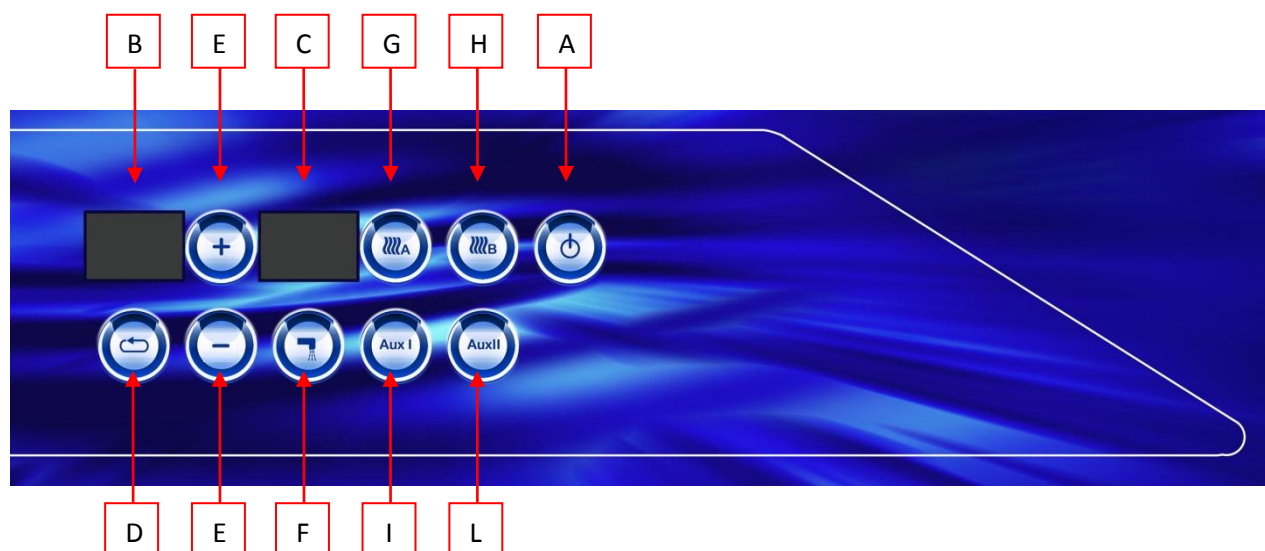

Connect the tempering machine to support (2) of the “bottom partial coating” optional device via tube (E).



5. Operation

5.1. Description of the controls



A		ON/OFF button	This button switches the machine on and off.
B		BELT SPEED display	This displays the speed of the air emitted from the blower.
C		BLOWER SPEED display	This displays the speed of the air emitted from the blower.
D		BELT CONTROL button	This button starts/stops the movement of the belt.
E		INCREASE/DECREASE BELT SPEED buttons	These buttons allow the user to increment/ decrement the values on the display.
F		BLOWER ON/OFF button	This button turns the blower on and off.
G		Auxiliary 220V OUTPUT button	-
H		Auxiliary 24V OUTPUT button	-
I		Auxiliary button 1 TO BE CONNECTED	-
L		Auxiliary button 2 TO BE CONNECTED	-

5.2. Machine adjustment

Use knob to regulate the air emitter to the desired height.



Use knob (3) to adjust the coating mesh vibration stopper (4).

This adjustment is mechanical.

Once the desired position is achieved lock knob (3) into place using lock (5).

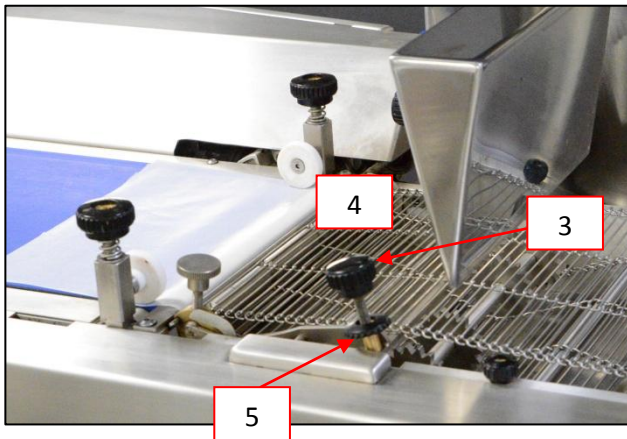

The height of the tail-cutting roller (6) needs to be adjusted according to the product to be coated by using the two knobs (7).

When adjusting the tail-cutting roller always keep it parallel to the coating plane.

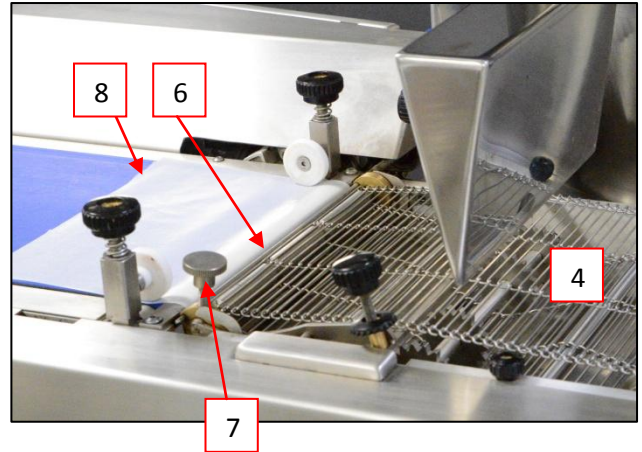

Normally the height of the tail-cutting roller (6) should be at the same height of the unload belt (8) as can be seen in the diagram.

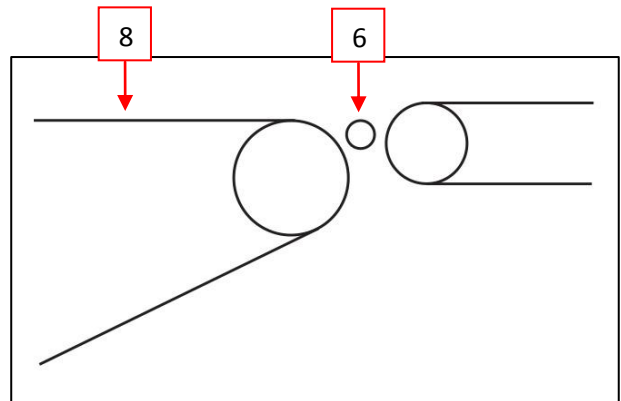

The height of the coating mesh (4) must be positioned 3 - 4 mm above the plane of the unload belt (8)

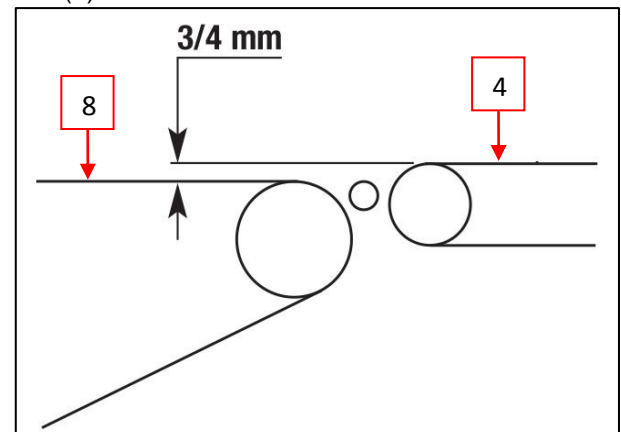

5.3. Using the machine

Attention

The use of the machine is forbidden to non authorised personnel who have not been trained in its use.

Operators who carry out permitted activities on the machine must receive adequate instructions with regards to personal protection equipment which eliminates the risks from the execution of various activities.

Turn on the machine via the black mains switch.



Press the **ON/OFF** button (A).

Check that the mesh in the coating area is not blocked by solidified chocolate.



If this is the case it will be necessary to heat the coating area with a heat gun until the residual chocolate has completely melted..

Warning



Press the belt control button (D) to set the belt in motion and check that the belt and the mesh in the coating area both move in a regular manner. If this is not the case stop the belt and repeat the chocolate melting procedure.



In order to regulate the speed of the belt press the **BELT CONTROL** button (D) for at least three seconds (display (B) will flash) and then use the two **INCREASE / DECREASE BELT SPEED** buttons (E) to set the desired speed.



After a few seconds the set speed will be automatically applied.



If the coated product needs a further drain of excess chocolate press the **BLOWER ON/OFF** button (F) in order to activate the pressure blower.



The amount of air needed for the draining of the specific product used can be regulated by pressing and holding the **BLOWER ON/OFF** button (F) for at least three seconds (display (C) will flash) and using the **INCREASE/ DECREASE BELT SPEED** buttons (E) to set the desired value.

Processing of the product

Manually place the product in the loading area and press knob (1) to move the product into the coating area.

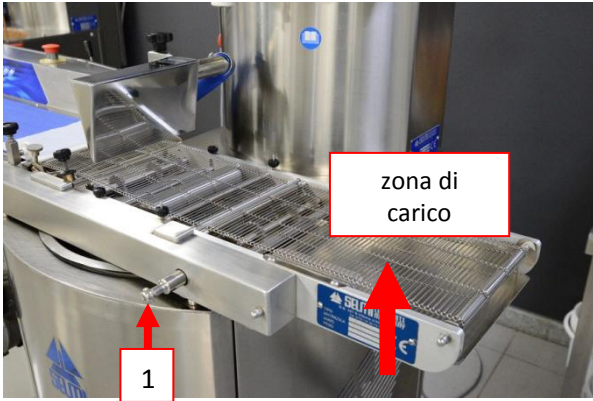

The product will pass through the dual veil chocolate distribution hopper as shown in the picture.



The product will be coated from beneath via roller (2).



Product coating area.



Move lever (3) as shown to unlock the supporting paper (4).

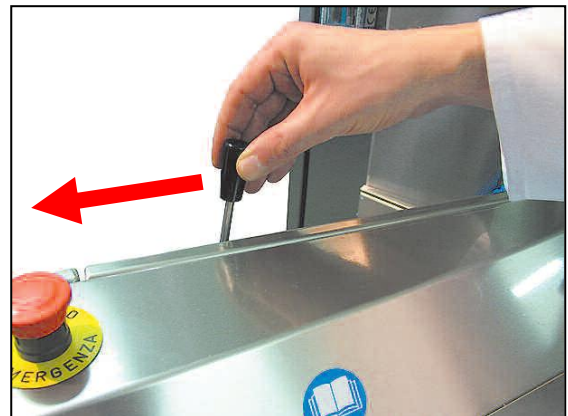

Once the product has gone through, the supporting paper (4) will need to be locked once more by moving lever (3) as shown in the picture.

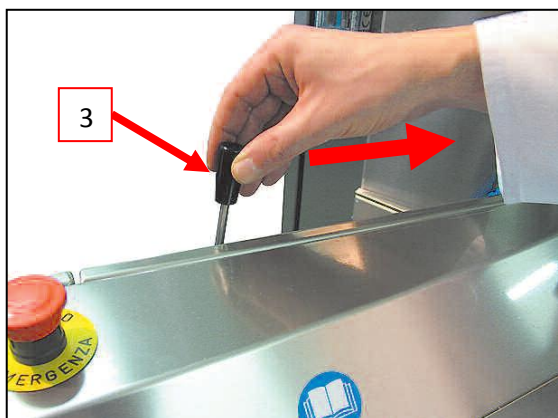

Use scissors to cut the paper holding the processed product and move everything to the previously prepared tray (5).

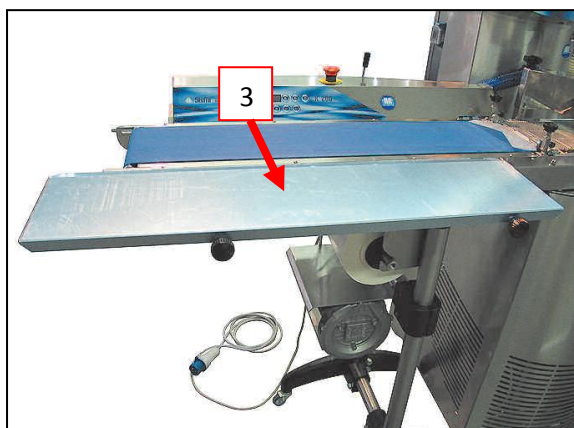

Pull knob (1) to halt the onward motion of the loading area and start a new processing cycle.



5.5. Position of the user

During the working cycle a sole operator is needed located in front of the working panel with easy access to the emergency button.

5.6. Involuntary electrical interruptions

If the voltage supply were to fail during the working cycle, a thermostat will prevent the machine from functioning for about 10/15 minutes (following the restoration operations) to allow the machine to return to its working temperature.

6. Maintenance section

6.1. General information

Attention

The product present in the tank or internally to the machine must NEVER come into contact with water or other liquids: this may lead to the formation of moulds and bacterial loads.

Attention

If a bacterial presence is found on the product derived from the processing carried out with this machine model it will be necessary to stop production immediately and contact the manufacturer for the disinfection procedures.

Before carrying out maintenance or cleaning procedures on the machine, cover the tank with the supplied lid.

Never clean or lubricate components in motion.

Warning

Extraordinary maintenance on the machine is exclusively carried out by the technicians approved by the manufacturer.

The training course carried out only gives the client the base instructions for ordinary maintenance. The manufacturer suggests carrying out a full service every two years to guarantee the safety conditions.

Note

The maintenance technician must note on an appropriate logbook all the interventions carried out on the machine.

This section describes the ordinary checking and maintenance procedures needed to guarantee the correct functioning of the machine.

Any other intervention that may be necessary to eliminate anomalies or faults must be expressly authorized by the manufacturer.

For major repairs it is recommended to turn to the manufacturer whose specialized personnel, possessing the technical expertise acquired from the original manufacturing in the factory, are always reachable and able to intervene quickly.

For maintenance or replacement of commercial components installed on the machine keep to the instructions provided directly by the manufacturers.

Such instructions are normally attached to the components or obtainable via catalogues or manuals provided by the manufacturers.

Environment

The components replaced during maintenance operations must be disposed of according to the laws in force concerning waste materials. If necessary, they can be sent to the manufacturer, who will dispose of them in the most appropriate manner.

6.2. General safety practice

Maintenance work must be carried out by specialised personnel who are trained in specific sectors, which for this machine are:

- mechanical maintenance technician;
- electrical maintenance technician.

It is the duty of the Safety Officer to ascertain the professionalism and competence of the abovementioned people.

Before starting a maintenance procedure the safety officer must:

Clear the working area of extraneous materials and people.

Make sure that the necessary tools are conveniently available to the maintenance technician and that they are in good condition.

Make sure that the lighting is sufficient and provide, if necessary, portable 24V lights.

Make sure that the maintenance technician is equipped with the necessary approved personal protection equipment for the specific operation (gloves, safety glasses, shoes, etc.).

Make sure that the maintenance technician has carefully read the instructions contained in this manual and knows perfectly the functioning of the machine. Before starting a maintenance procedure the maintenance technician must disconnect all the supplies to the machine (electrical, oil, pneumatic) and make the machine safe.

At the end of the procedure and before restarting service, the maintenance technician must check the entire working cycle, the functionality of the safety devices and the integrity of the protections.

Work on motors or on other electrical components must only be carried out by the electrical maintenance technician specially trained and authorised by the Safety Officer.

Attention

Following every maintenance intervention it is the Safety Officer's duty to ascertain the safety conditions of the machine and its protection devices.

During maintenance proceedings it is recommended to place a sign on the machine forbidding its movement.

The maximum reliability of the machine and a minimum maintenance cost are the results of a planned program of maintenance and inspection scrupulously followed during the entire life of the machine.

Strictly respect the maintenance time intervals and space them out according to the specific necessities in relation to the productive cycle of the machine.

Always use tools which are in good working order and appropriate for the task at hand; the use of inappropriate or inefficient tools can cause serious damage.

Unless expressly required for the solution of a breakdown, never interfere with the adjustments and positioning of the limit microswitches; their tampering can cause serious damage to the machine.

During disassembly distinguish and take note of the individual parts so as to assure their correct reassembly.

Before assembling a block always cover with a thin layer of oil the internal parts and coupled surfaces. Replace all the seals and gaskets with original parts before reassembling the components.

Always check for the presence of earth connections and their compliance to the norms.

Before starting the machine always check that the personnel responsible for the maintenance is at a safety distance and that tools or materials have not been left in the vicinity of the machine.

6.3. Cleaning the machine

Attention

Place the supplied lid on the tank.

Attention

Make sure that the chocolate present inside the tank and inside the machine does not come into contact with water or other liquids. There is a risk of mould formation leading to bacterial presence.

Before beginning any checking or maintenance operations it will be necessary to vacuum all the dirt present on the machine and remove the rest with appropriate solvents, avoiding the use of compressed air jets which can create zones of dirt accumulation and may cause injury to the individuals present in the cleaning area.

Clean persistent stains with dry and soft cloths that do not fray or use flexible bristle brushes.

If the stains are incrustated and hard to remove with cloths or dry brushes use an appropriate liquid solvent. Use personal safety equipment.

6.4. Maintenance of mechanical parts

Carry out the dismantling and movement of heavy components (over 30Kg) with the help of block and tackles or cranes.

If detailed diagrams are not available take note of every item and mark its location so as to avoid errors in reassembling.

Always use spanners of the correct size.

Immediately replace screws or bolts which show signs of wear on the threads and the heads.

When screwing and unscrewing do not use the spanners in conjunction with extensions to augment the torque. If dynamometric spanners and special tools are used verify that the calibration is appropriate for the component.

Special care must be taken when using pneumatic or hydraulic tools.

Before dismantling heavily oxidised parts spray them with adequate liquids (Svitol, etc.).

Before reassembling cover thinly with oil all the coupled surfaces.

During reassembly pay particular attention to anti-slip devices used by the manufacturer (flat washers, elastic washers, etc.), always replacing the worn out elements.

The anti-slip nuts and ring nuts having a plastic blocking ring must be replaced at every reassembly since the fatigued material will lose its functionality.

Attention

Always use personal protection equipment such as gloves, anti-injury shoes, etc.

6.5. Maintenance of electrical system

Before taking any action on electrical components disconnect the mains-side supply (main power switch). Always carefully check the isolating covers, the clamps and the grip of the sheaths.

This must always conform to the level of protection stated by the manufacturer.

Immediately replace the damaged gaskets and sheaths.

Check and restore, if necessary, the identification labels and stickers of the wires and of the components keeping to the indications shown in the diagrams.

Make sure that the hazard indications and explanatory plaques required by the norms are perfectly legible and firmly fixed.

Do not use compressed air for cleaning.

Use exclusively vacuum machines.

The replacement of faulty control components must always be carried out according to the norms (colours, dimensions, protections, etc.).

In the case of replacement of the microcircuit board connect the wires onto the new board as shown in the figure.



6.6. Components subject to wear and tear and fatigue

Attention

Components subject to wear and tear due to their work must be rigorously checked periodically and replaced when they show noticeable signs of wear.

The manufacturer has designed and built the machine to last for a reasonable amount of time taking into consideration the normal conditions of use of the Client; it is nevertheless necessary to periodically check all of these components carefully.

If mechanical fissures or permanent or cyclical structural deformations are found immediately contact the manufacturer and the expert technicians who will take the necessary steps.

The electrical wires will lose their isolating properties with time, especially if exposed to heat, humidity and low temperatures.

Verify their integrity with the help of expert technicians. All electrical components having mechanical moving parts during the working cycle (buttons, selectors, relays, etc.) are guaranteed by the manufacturer for a high, but always limited, number of cycles.

Frequently check their condition and consult with technical experts for the potential periodic replacement within their guaranteed lifespan.

6.7. Planned preventive maintenance

AT THE START OF EVERY PROCESSING

Emergency button check.
Check the functionality of the emergency button.

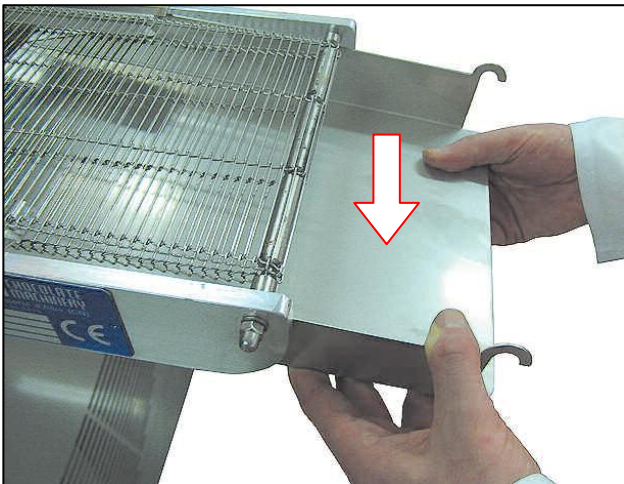
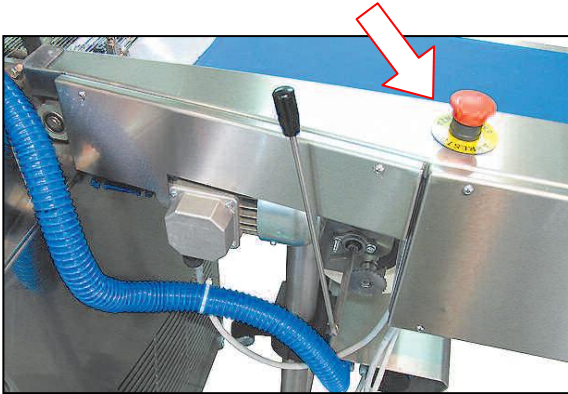

Cleaning of the crumbs collector.
Dismantle and clean the crumbs collector.

EVERY SIX MONTHS

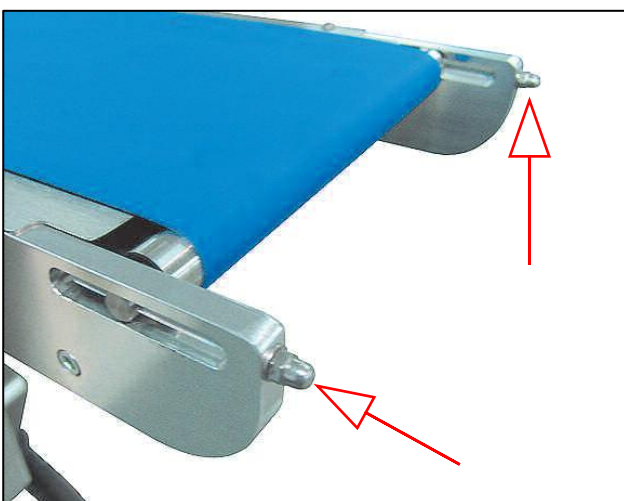

Check the belt tension.
Check the belt tension and if necessary stretch it using the indicated tension regulators.

Chain Tension
To adjust the chain tension operate on the two nuts (A) and (B):

Rotate anticlockwise to decrease the chain tension

Rotate clockwise to increase the chain tension.

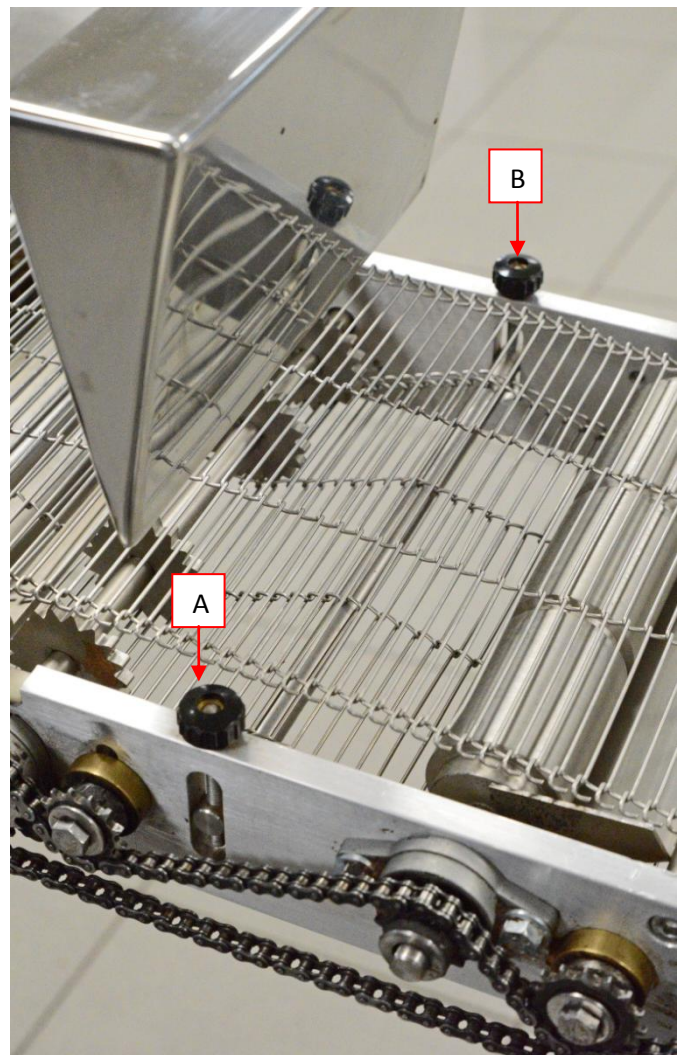

Lubrication and tension of the chain.

To carry out the lubrication and tension adjustment of the transmission chain one will need to:

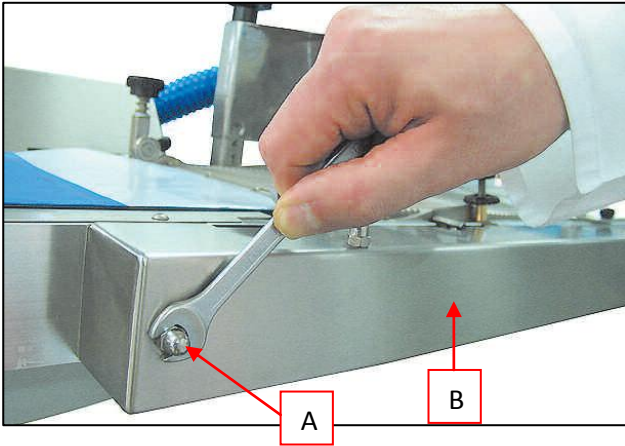

- unscrew the 2 bolts (A) which holds guard (B) in place and extract the carter as shown in picture.



- lubricate the chain with the appropriate oil.

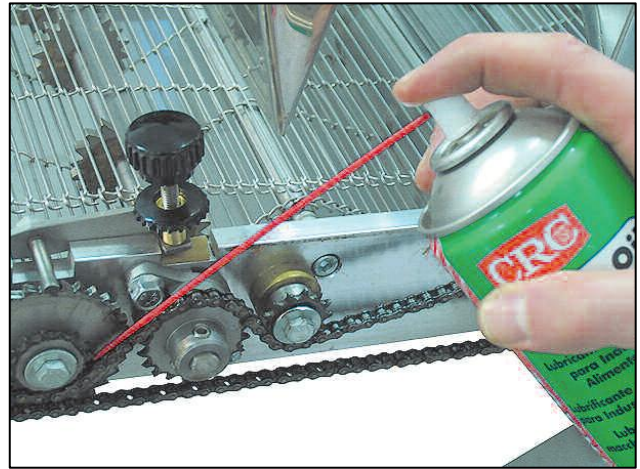

Check safety microswitch.

Check the correct functionality of the safety microswitch for the opening of the electric panel door.



BREAKDOWNS

Roller replacement.

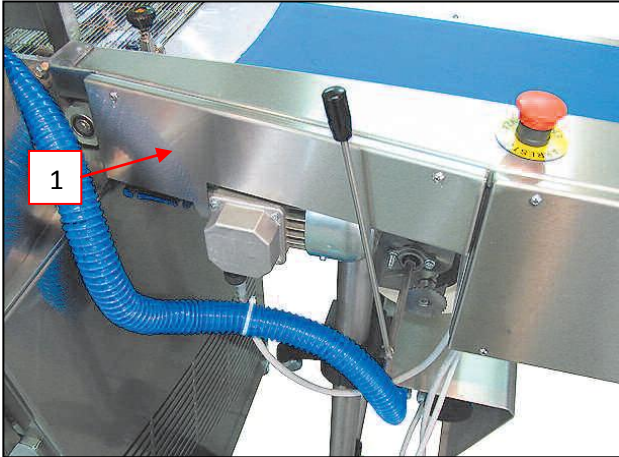

1- Unscrew the 2 screws and remove the protection (1);

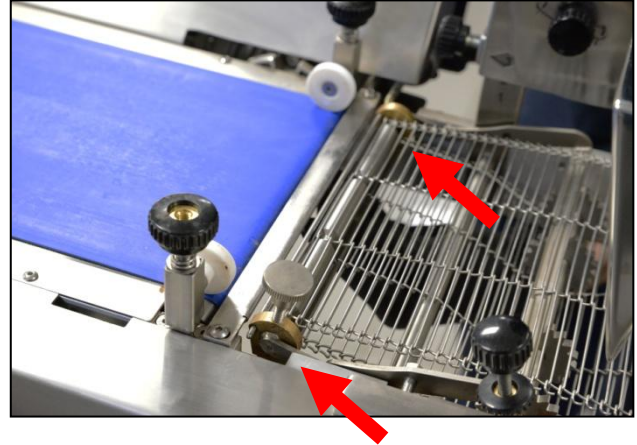

4 - Unscrew the 2 pairs of screws under the net

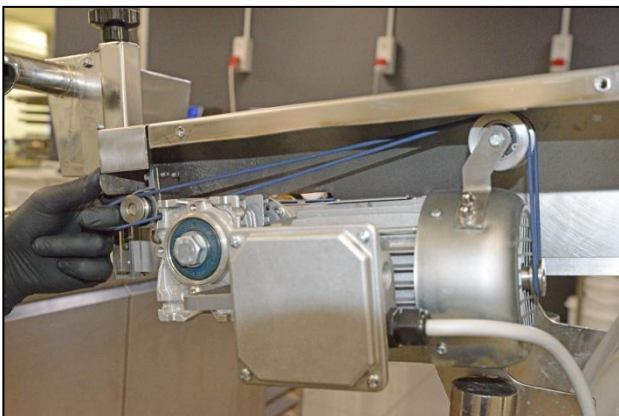

2 - Remove the belt

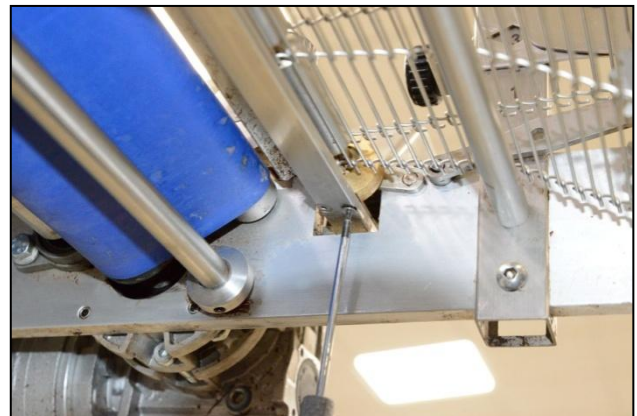

5 - Unscrew the 2 pairs of screws under the net



3 - Remove the crumb tray

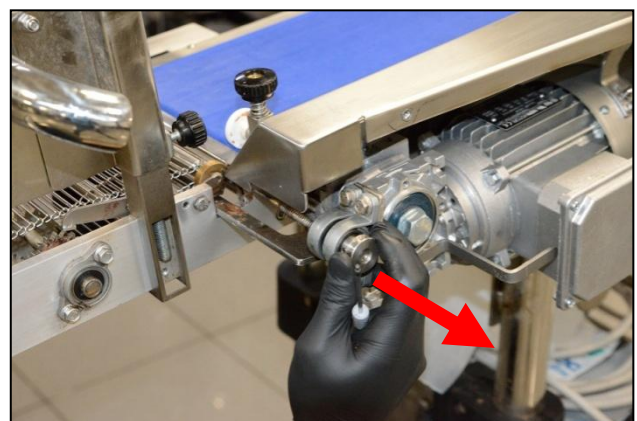

6 - Remove the roller

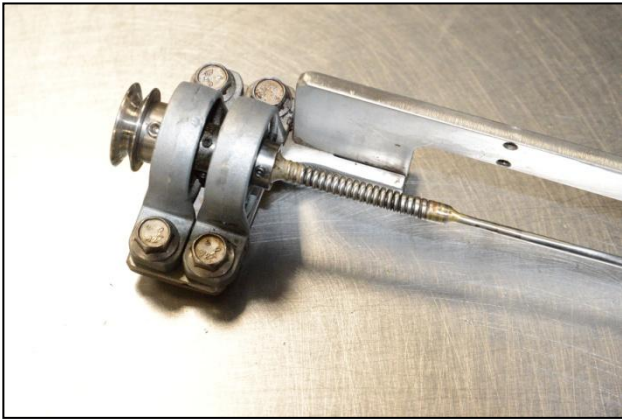

7 - Remove the roll from its structure



10 - Remove the roller



8 - Unscrew the two screws that secure it to the first bearing



11 - Unscrew the pulley

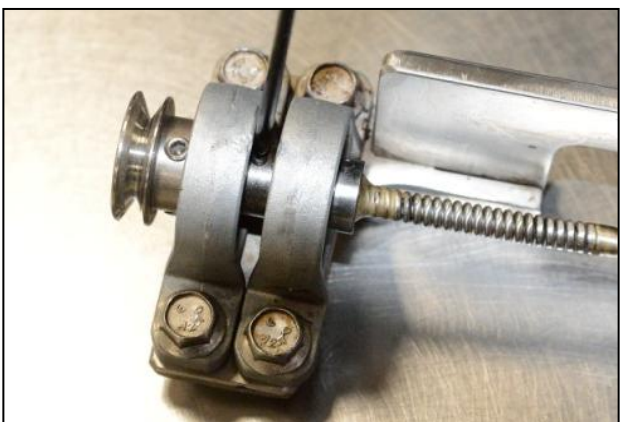

9- Then the two screws that fix it to the second bearing



12 - Remove the roller and replace it with a new one.

13 - Reassemble the roller

BREAKDOWNS

Replacement of the tail-cutting roller and drive belt.

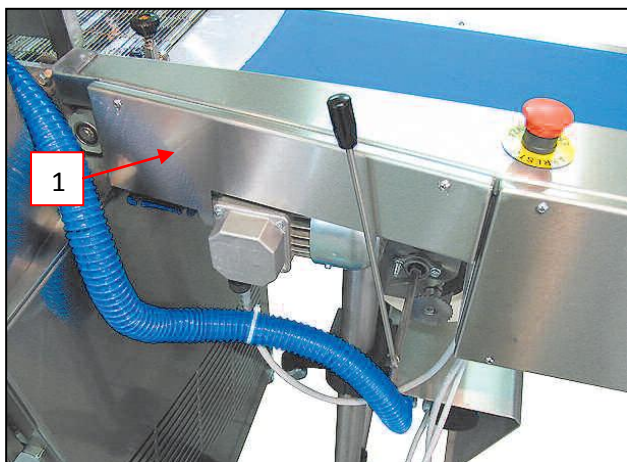

- unscrew the screws and remove the protective guard (1);

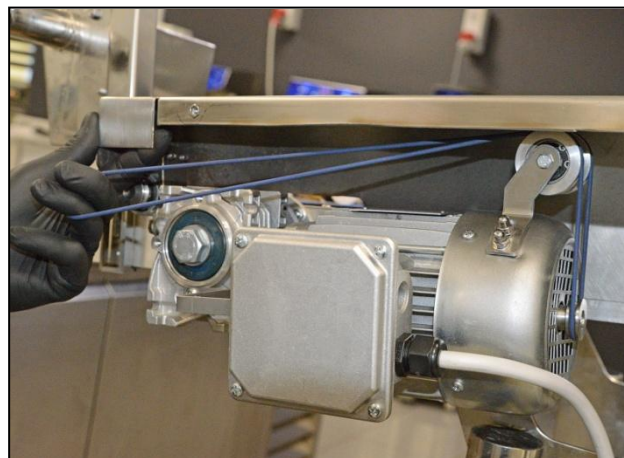

4 - Pass the belt on the two pulleys



2 - Insert the belt around the motor pulley

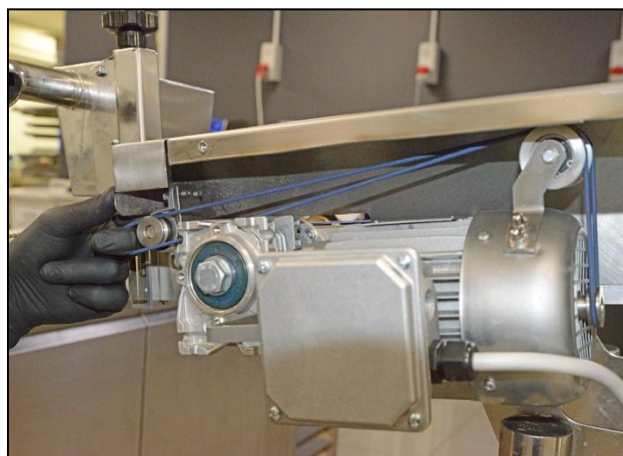

5 - Insert the belt on the roller pulley



3 - Pass the belt on the two pulleys

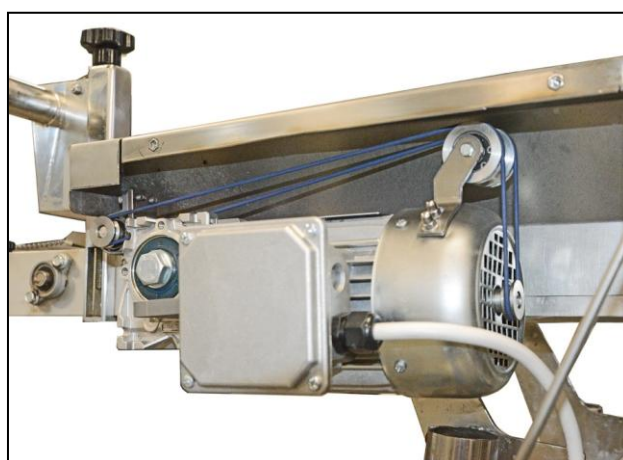

6 - Replacement carried out

Replacement and installation of the paper roll

In order to replace the paper roll unscrew the nut (A) and pull out the paper support kit (B).

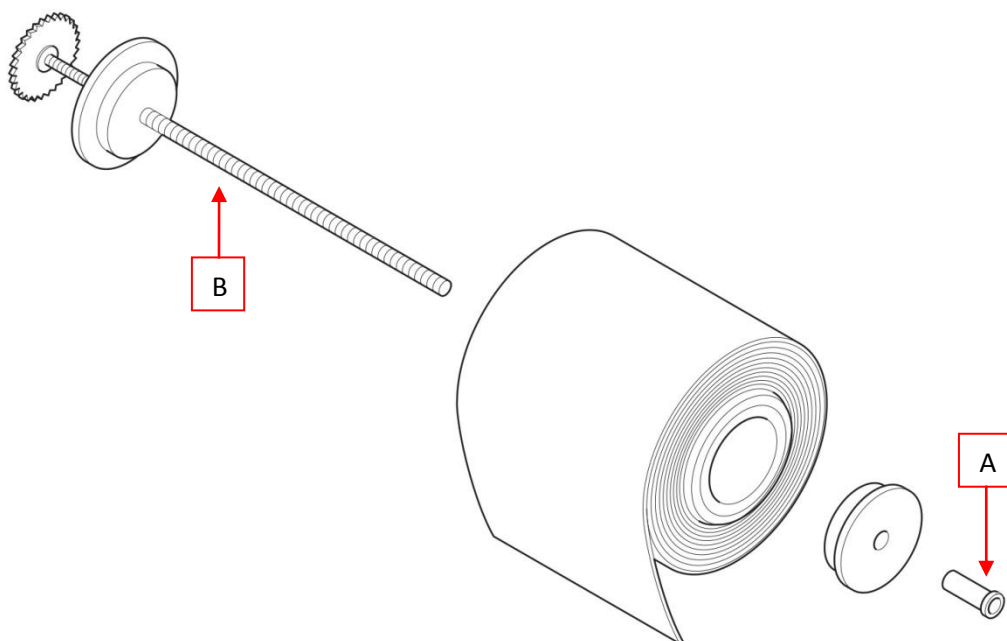

Mount the new paper roll inserting it in the slots indicated by the arrow.



Adjust via the knobs (C), making sure that the paper roll turns in a uniform manner over the unload belt.

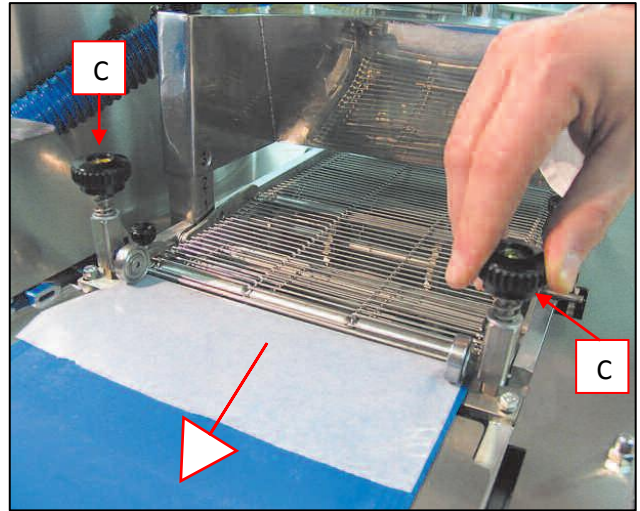

Thread the paper according to the arrows in the diagrams below.

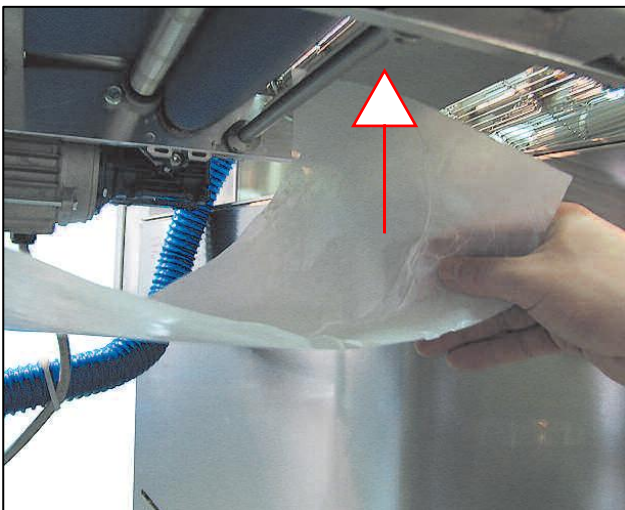
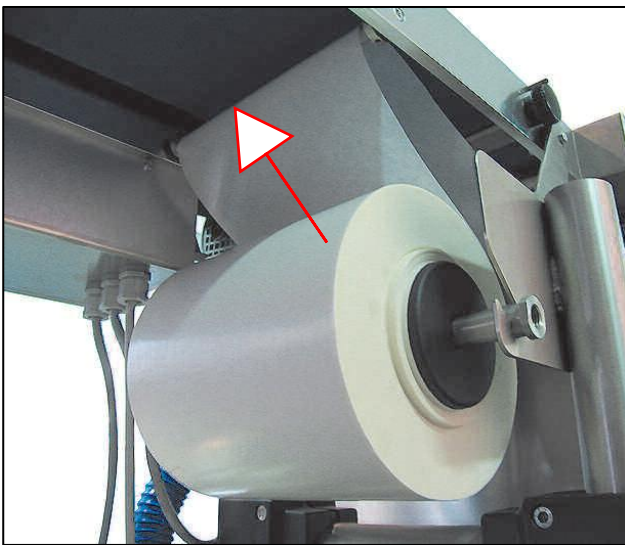

7. Technical diagrams section

7.1. Electrical circuit diagram

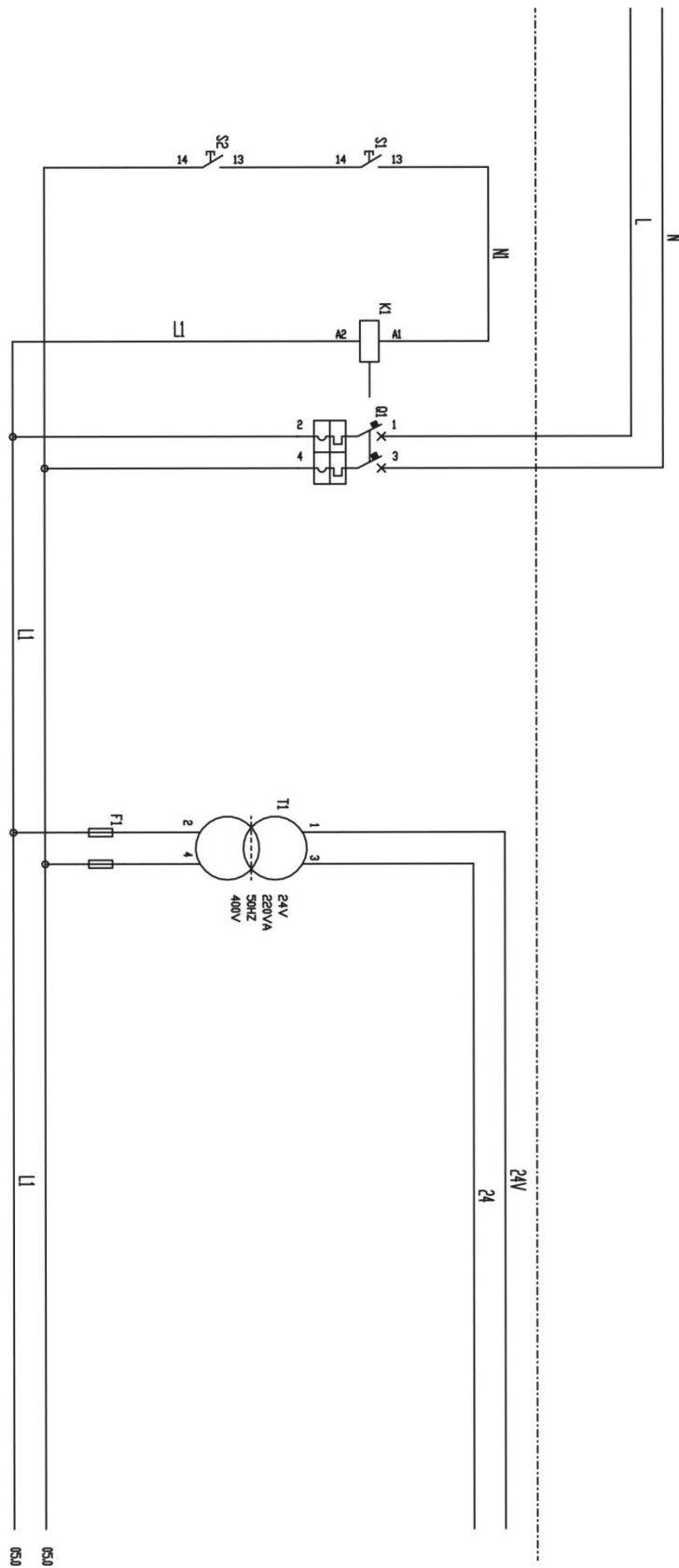

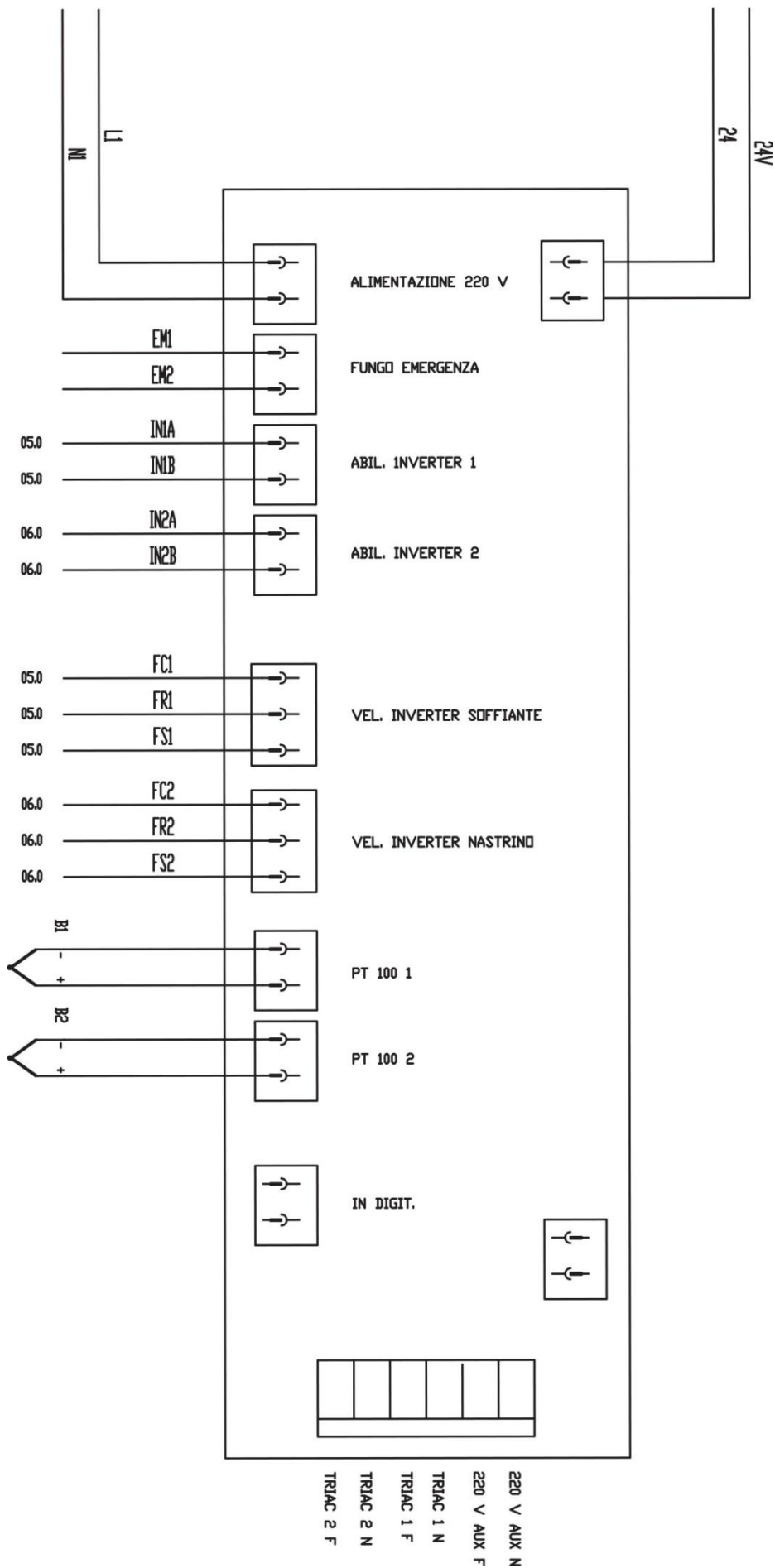

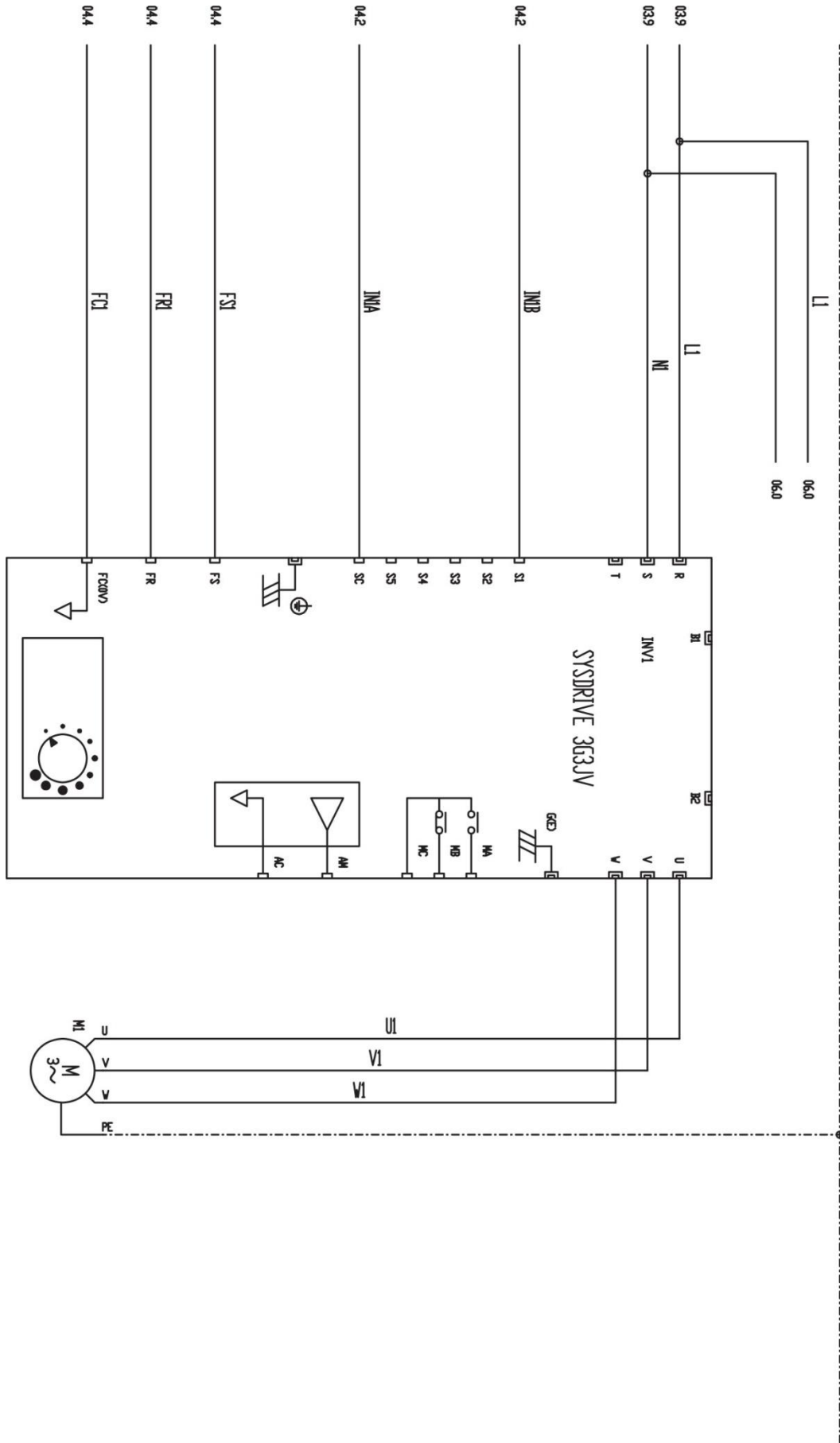

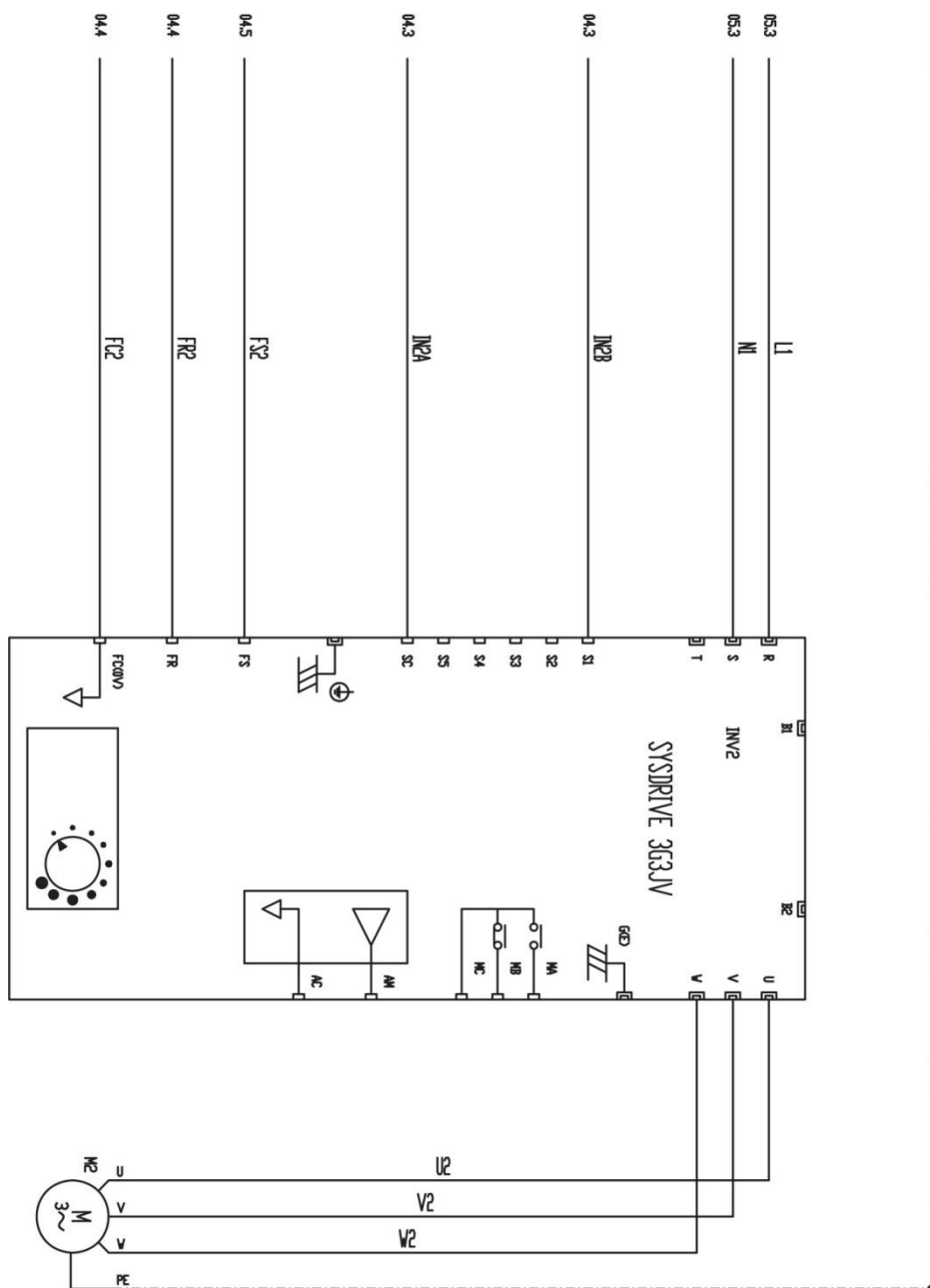

8. Spare Parts Section

	RS200 001 Paper adjustment kit
	RS200 002 Paper drawing bearing
	RS200 003 Transmission chain
	RS200 004 Shaft support
	RS200 005 Small roller belt
	RS200 006 Coating area mesh
	RS200 007 Loading area mesh
	RS200 008 Roller adjustment knob
	RS200 009 Vibration regulator adjustment knob

	RS200 010 Chocolate collecting slide
	RS200 011 Pivot wheel
	RS200 012 Belt drive roller
	RS200 013 Tail-cutting roller
	RS200 014 Conveyor belt
	RS200 015 Blower
	RS200 016 Roller scraper
	RS200 017 Chocolate distribution hopper
	RS200 018 Crumbs collector

	RS200 019 Electrical motor
	RS200 020 Reducer
	RS200 021 Reducer Flange
	RS200 022 Paper support kit
	RS200 023 Paper locking flange
	RS200 024 Blower filter
	RS200 025 200 mm paper roll
	RS200 026 Tray
	RS200 027 Tube complete with attachments

	RS200 028 Tube with bands
	RS200 029 Ventilation tube with bands
	RS200 030 Emergency circuit breaker
	RS200 031 Main switch
	RS200 032 Main switch casing
	RS200 033 Microswitch
	RS200 034 Display board
	RS200 035 Emergency contact
	RS200 036 Red mushroom push button

	<p>RS200 037 Inverter</p>
	<p>RS200 038 Membrane display</p>
	<p>RS200 039 Triangolo blower</p>
	<p>RS200 040 Roller charging section</p>

Use exclusively original SELMI spare parts



Selmi Srl assumes no responsibility for the use of non original replacement parts.