

TANK

200 - 400

USER AND SERVICE MANUAL



PREFAZIONE

SELMI S.r.l. would like to thank you for purchasing our "TANK". This manual is to be considered an integral part of the machine and its purpose is to allow use of the machine throughout its life, from delivery until demolition. Therefore, we suggest that you read it carefully. Everyone working with the machine must read this manual. It is also necessary to keep the manual in a place accessible to operators at all times.

In the event of loss or damage of this manual, please ask SELMI S.r.l. to send you a replacement copy.

The technical information contained in this manual belongs to SELMI S.r.l. and must be considered proprietary.

The total or partial reproduction of the graphic design, text and illustrations is forbidden

With a view to constant technical improvement, the company reserves the right to make any necessary amendments to the content of the manual, to the machine or to parts thereof. Consequently, some of the illustrations may differ slightly from your machine.

This document is an integral part of the "TANK", as described in section 1.7.4 of annex I of directive 2006/42/EC.

The Italian edition of this manual contains the original instructions. The foreign language editions are to be considered as translations of the original instructions.

© Copyright SELMI S.r.l.
Edition September 2019



EC DECLARATION OF CONFORMITY

The manufacturing company SELMI S.r.l., with main office in S. Vittoria D'Alba (CN) Italy – Via Statale, 151, in its capacity as manufacturer, declares, under its own responsibility, that the machine named:

"TANK"

Serial number:

is compliant with all the provisions contained in the following directives: 2006/42/EC (machine directive), 2014/30/UE (electromagnetic compatibility) 2014/35/UE (low voltage directive) and EC regulation 1935/2004 (contact with foodstuffs).

The norms adhered to that are used as a reference for the design, realization and testing of the machine are listed in the technical files archived at Selmi Srl.

The manufacturer also wishes to inform you that the technical file may, in the cases envisaged by the directive, be put together by the manufacturing company.

Year of construction:

Date:



The liable person

1. General information	1	3. Moving and transportation section	19
1.1. Structure of the manual	1	3.1. General norms	19
1.2. Messages Used	1	3.2. Packaging	19
1.3. Aim and contents	1	3.3. Transportation	20
1.4. Preservation of the manual	1	3.4. Removal of the packaging	20
1.5. External components	2	4. Installation section	21
1.6. Internal components	3	4.1. Positioning	22
1.7. Details of the manufacturer	10	4.2. Electrical connections	22
1.8. Identification plate of the machine	10	4.3. Installation of the machine	18
1.9. Identification plate of the CE marking	10	4.4. Commissioning	18
1.10. Inteded use	10	5. Operation section	22
1.11. Operating environment	10	5.1. Description of the controls	22
1.12. Noise level	10	5.2. Functions of the buttons	22
1.13. Technical characteristics	9	5.3. Using the machine	22
1.14. Dimensions	9	5.4. Position of the user	22
1.15. Storage	12	6. Maintenance section	28
1.16. Disposal	12	6.1. General information	30
1.17. Warranty	12	6.2. General safety practice	30
1.18. person qualified to operate	13	6.3. Cleaning external parts	
2. Safety section	14	6.4. Emptying and cleaning the machine	48
2.1. Safety information	14	7. Technical diagrams section	50
2.2. Safety limitations	14	7.1. Electrical circuit diagram	50
2.3. Safety symbols and plaques	15	7. Technical diagrams section	40
2.4. Safety and protection devices	15		
2.5. Client's safety measures	17		
2.6. Personal protection equipment	17		
2.7. Residual risks	18		
2.8. Applied Directives	19		
2.9. Harmonized technical norms	19		

1. General information

1.1. Structure of the manual

To simplify the reading and understanding of the information contained in this manual and to make searches quicker, it has been divided into sections, each dedicated to a specific subject.

1.2. Messages used

Attention

This type of message is used to draw the reader's attention to more delicate or particular procedures which, if not carried out correctly, may pose a risk to the safety of the operator and cause damage to parts of the machine.

Warning

This type of message is used to draw the reader's attention to procedures which, if not carried out correctly or at pre-set intervals, may cause damage to the machine or its parts, as well as to the product being processed.

Environment

Messages relating to the environment draw the operator's attention to the rules to be followed to prevent the risk of environmental damages deriving, directly or indirectly, from use of the machine.

Note

These messages highlight instructions, advice and notes that can be particularly helpful during the various uses of the machine.

1.3. Aim and contents

This manual has been drawn up in consideration of the requirements of directive 2006/42/EC and paying particular attention to describing all the procedures necessary to obtain the best working conditions for the machine and its operators, without neglecting product quality:

The aim of this manual is, therefore, to provide the user with all the information necessary for the correct use and maintenance of the machine. Consequently it is absolutely necessary:

- to meticulously follow the instructions given in the manual during every phase of the machine's life, from transportation to demolition;
- for every machine operator to thoroughly read the contents of this manual;
- for the company's safety officer to make sure that all machine operators have clearly understood how the machine works

Attention

In case of doubts on the correct interpretation of the instructions please contact the manufacturer to obtain the necessary clarifications. All those carrying out any kind of operation on the machine must have thoroughly read and understood the contents of this instruction manual.

Warning

If this manual is damaged or lost, please ask the manufacturer or the authorised distributor in the country where the machine is being used for another copy.

1.4. Preservation of the manual

The instruction manual is an integral part of the machine and must be used to train and inform professional figures operating on the machine. Consequently, it is necessary to follow certain simple instructions regarding its preservation, as follows:

- store the manual in areas protected from humidity and heat, so as not to jeopardise the quality or legibility of any part of the publication;
- keep the manual in an easily accessible place known to the machine operators;
- avoid handling the manual with dirty or greasy hands;
- if you think it is necessary to highlight important steps of the manual, use non-permanent systems, to preserve its legibility;
- do not remove, rip or rewrite any parts of the manual for any reason.

1.5. External Components



1. Touch screen
2. Product exit point
3. Right protection panel
4. Swivelling wheels
5. Handle for the tank cover opening
6. Cover for the mixer transmission chain
7. Emergency button

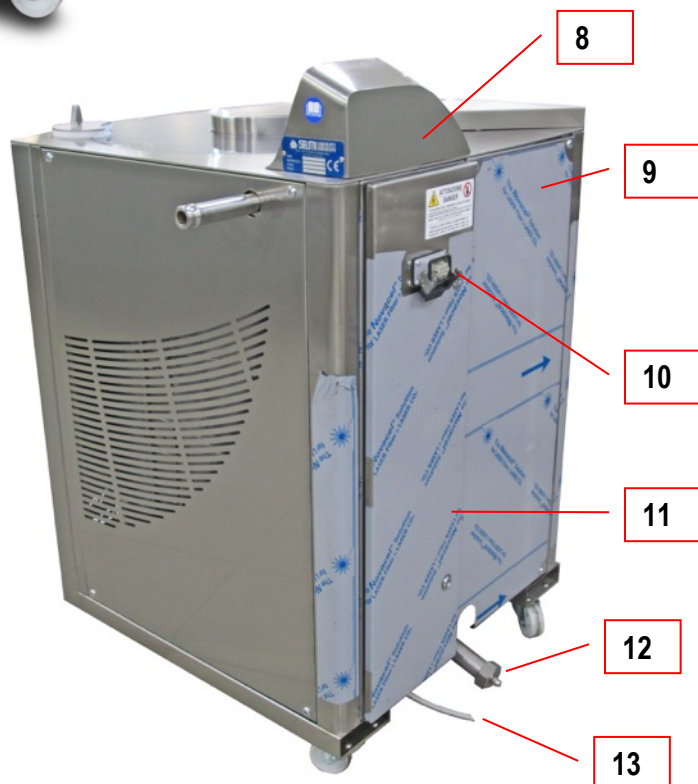

1.6. Internal Components**TANK 400**

- 1 - Mixer reducer
- 2 - Mixer motor
- 3 - Column for product exit point
- 4 - Unload / cleaning point
- 5 - Tank band resistance n°1
- 6 - Tank band resistance n°2
- 7 - Tank band resistance n°3
- 8 - Tank band resistance n°4
- 9 - Tank band resistance n°5
- 10 - Resistance temperature probe n° 1
- 11 - Resistance temperature probe n° 2
- 12 - Resistance temperature probe n° 3
- 13 - Resistance temperature probe n° 4
- 14 - Resistance temperature probe n° 5

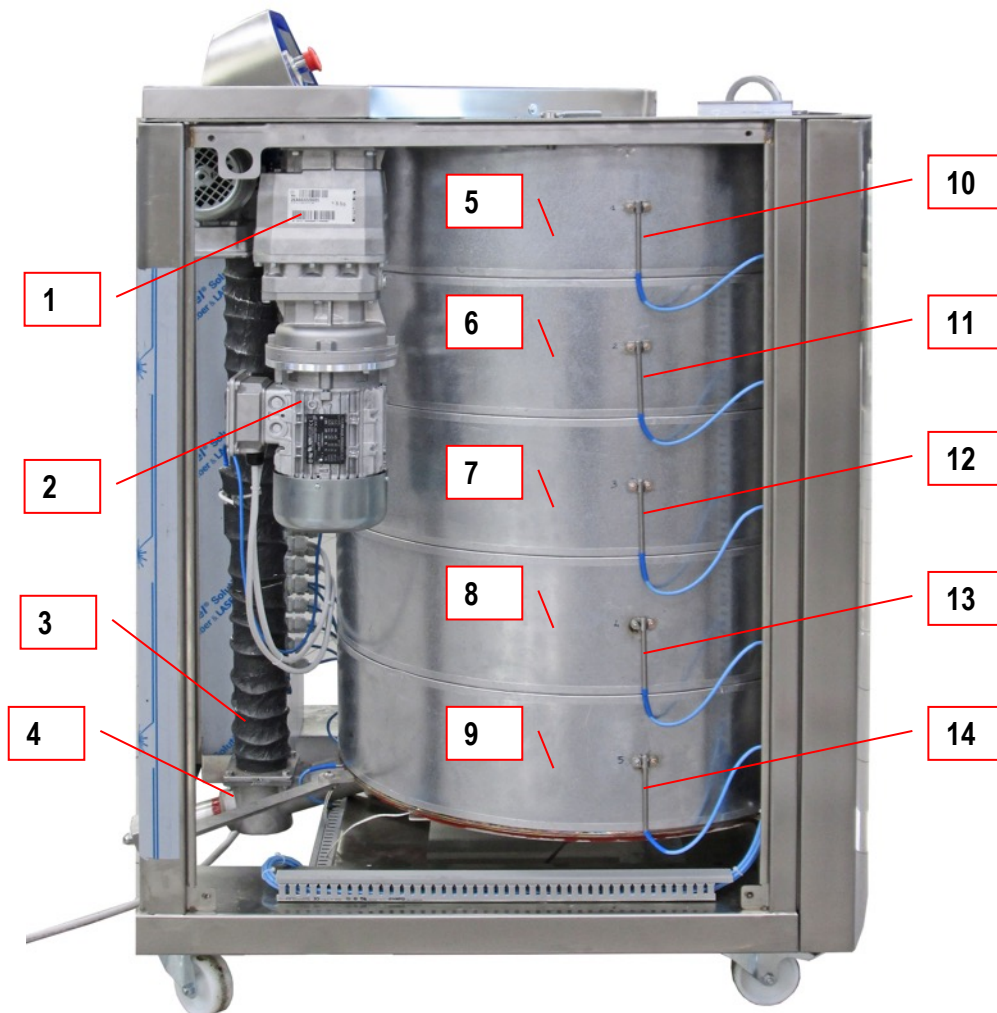

1.6. Internal Components

TANK 200

- 1 - Mixer reducer
- 2 - Column for product exit point
- 3 - Mixer motor
- 4 - Unload / cleaning point
- 5 - Tank band resistance n°1
- 6 - Tank band resistance n°2
- 7 - Tank band resistance n°3
- 8 - Resistance temperature probe n° 1
- 9 - Resistance temperature probe n° 2
- 10 - Resistance temperature probe n° 3

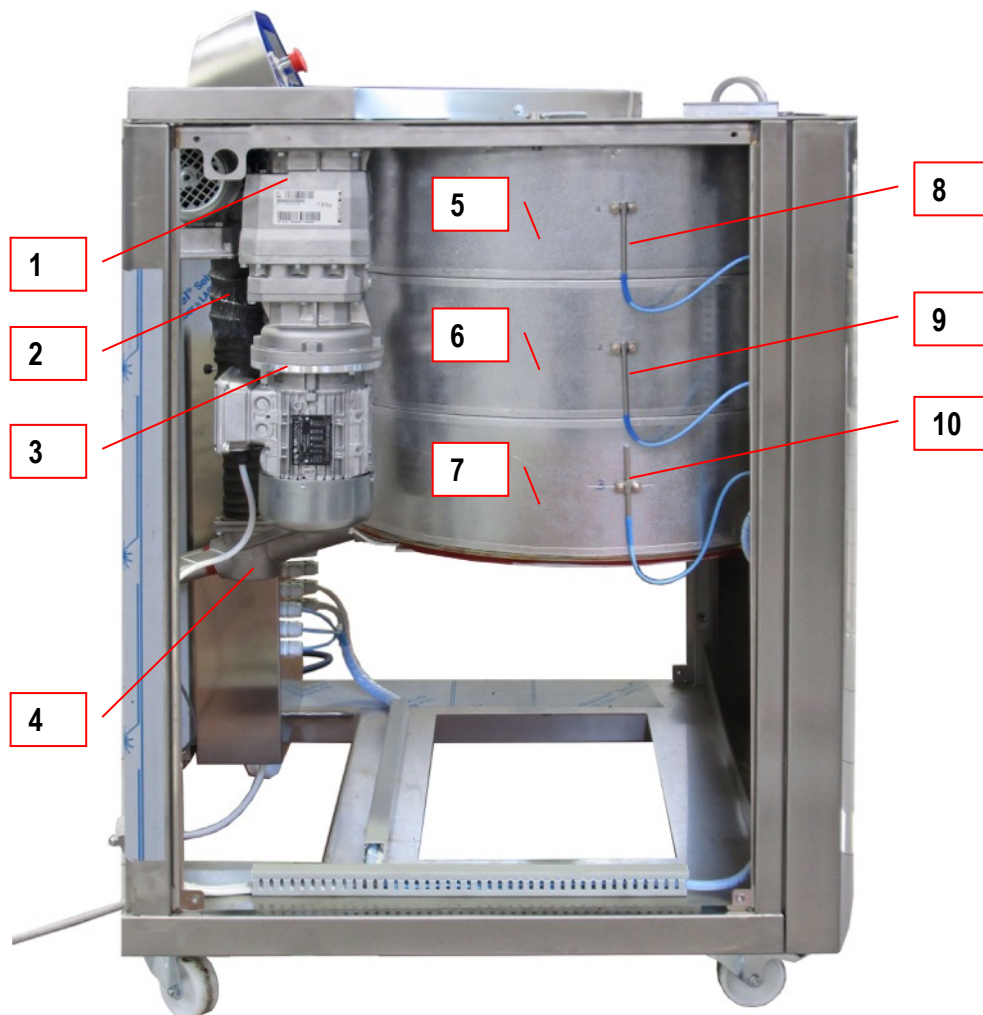

1.6. Internal Components**TANK 400**

- 1 - Tank band resistance n° 1
- 2 - Tank band resistance n° 2
- 3 - Tank band resistance n° 3
- 4 - Tank band resistance n° 4
- 5 - Tank band resistance n° 5
- 6 - Product exit point

FOR THE **TANK 200** ONLY 3 BAND RESISTANCES

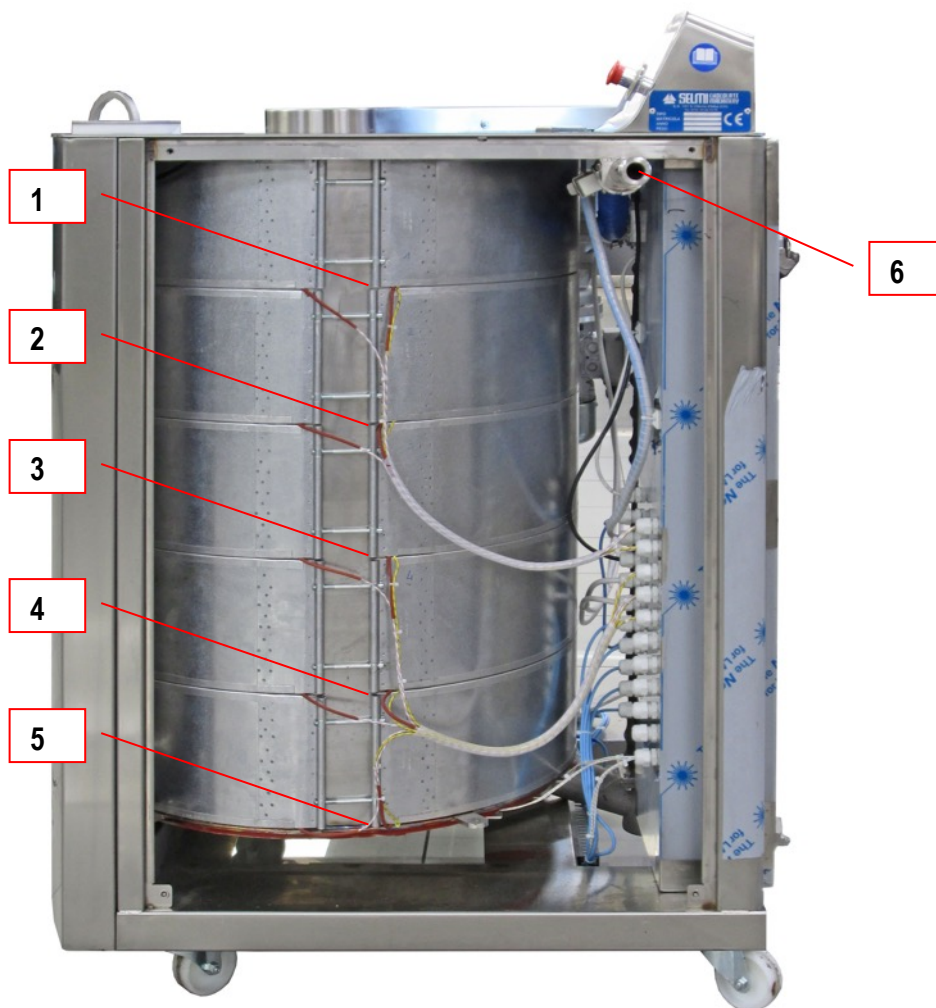

1.6. Internal Components

1. Touch screen
2. Product exit point
3. Pedal connection
4. Unload / cleaning point
5. Temperature probe for the column resistance
6. Column with resistance
7. Mixer motor
8. Mixer reducer
9. Product exit pump
10. Reducer

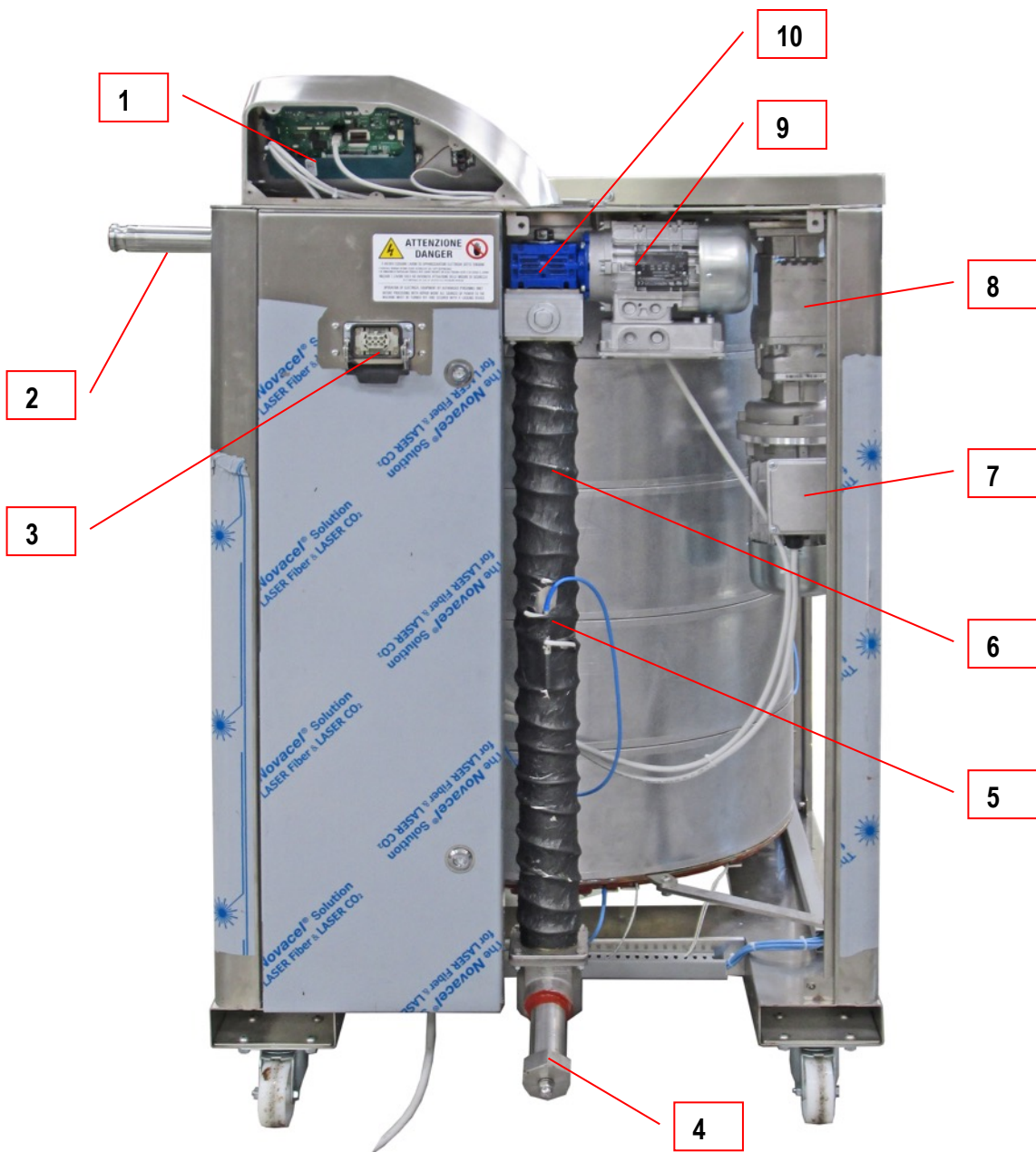

1.6. Internal Components

1. Mixer elements
2. Food grade plastic elements / scrapers for teh tank side
3. Food grade plastic elements / scrapers for teh tank bottom

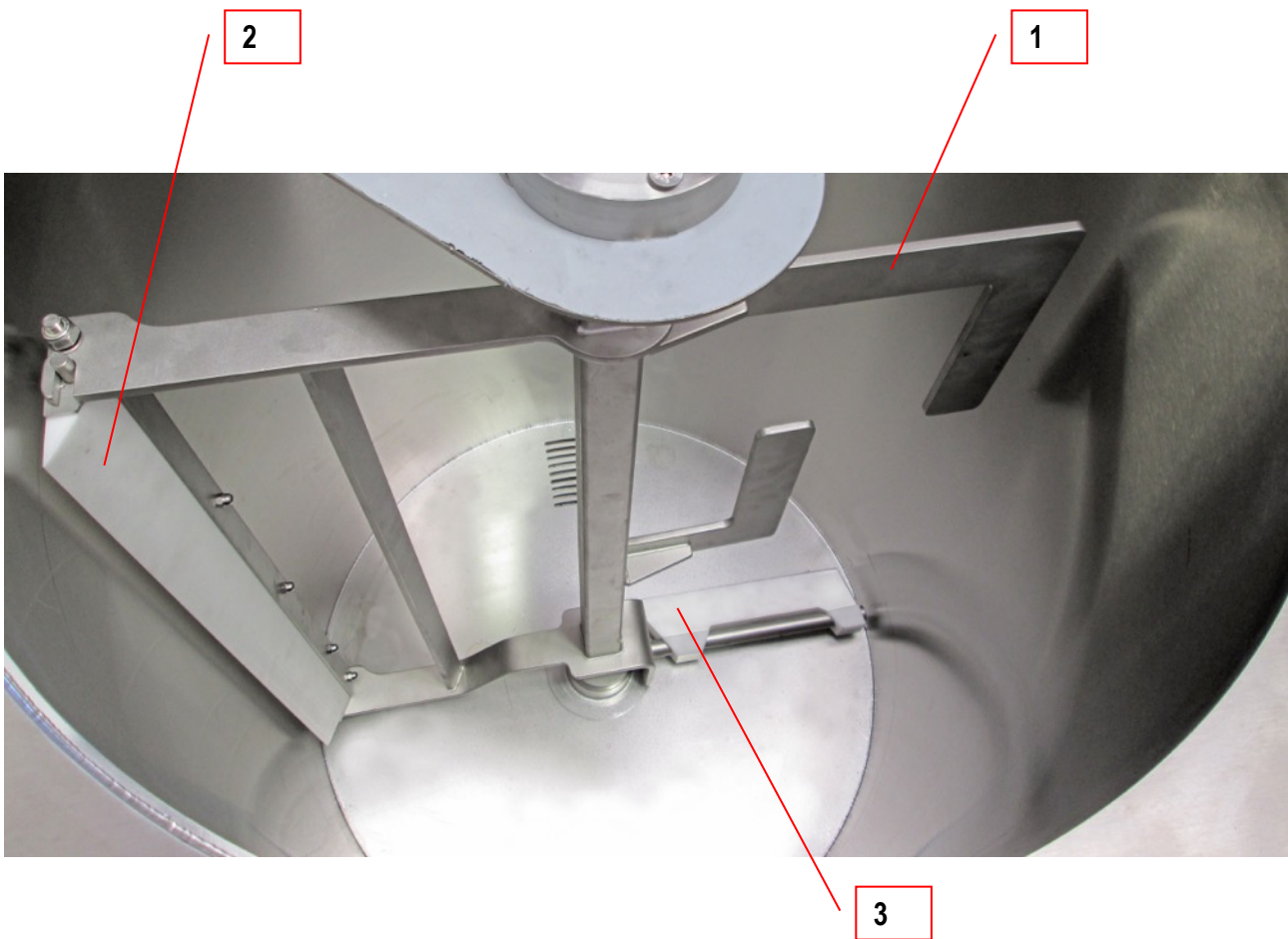

Electrical panel

1. Power board
2. Safety module
3. Main contactor
4. Transformer
5. Fuse holder
6. Power board
7. Ground connection
8. Micro security electrical panel door
9. Touch screen

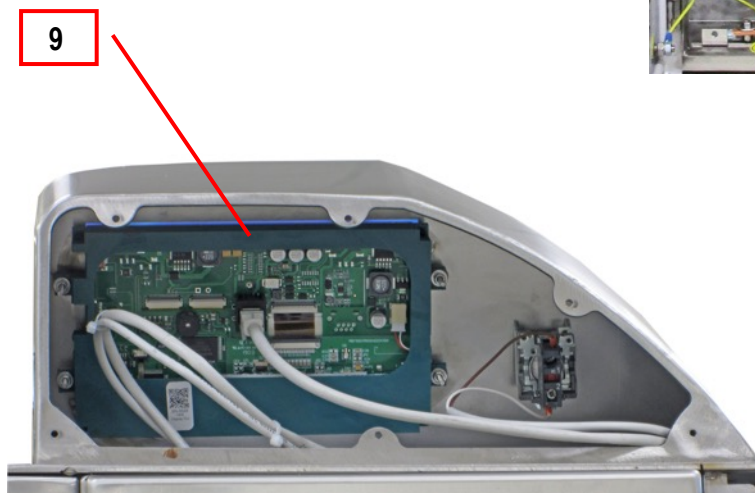
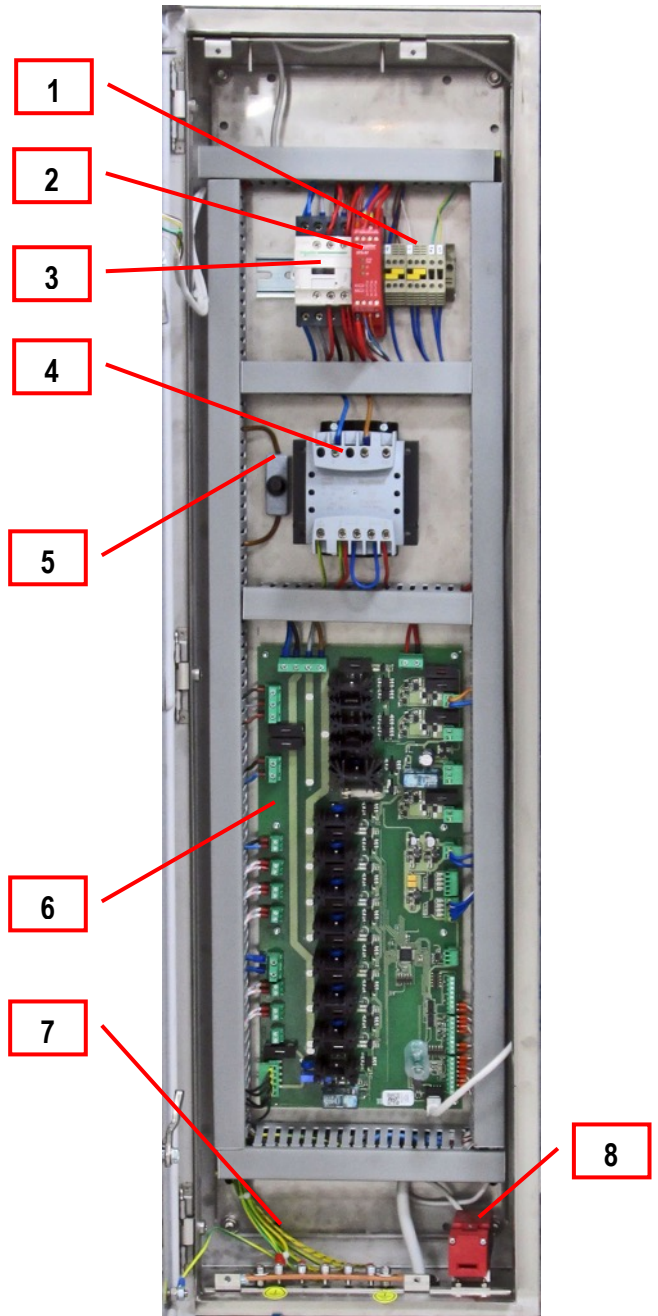

1.9. Power board

- 1 - Supply line 380V
- 2 - Mixer motor
- 3 - Tank bottom resistance
- 4 - Column resistance
- 5 - Tank band resistance n° 1
- 6 - Tank band resistance n° 2
- 7 - Tank band resistance n° 3
- 8 - Tank band resistance n° 4
- 9 - Tank band resistance n° 5
- 10 - Pump motor
- 11 - Flat cable connection
- 12 - Probe n° 1
- 13 - Probe n° 2
- 14 - Probe n° 3
- 15 - Probe n° 4
- 16 - Probe n° 5
- 17 - Column probe
- 18 - Tank bottom probe
- 19 - Product exit probe
- 20 - Pedal
- 21 - Emergency button
- 22 - Level sensor feed
- 23 - Safety level sensor
- 24 - Exit product pipe resistance
- 25 - Power board supply 24 ac

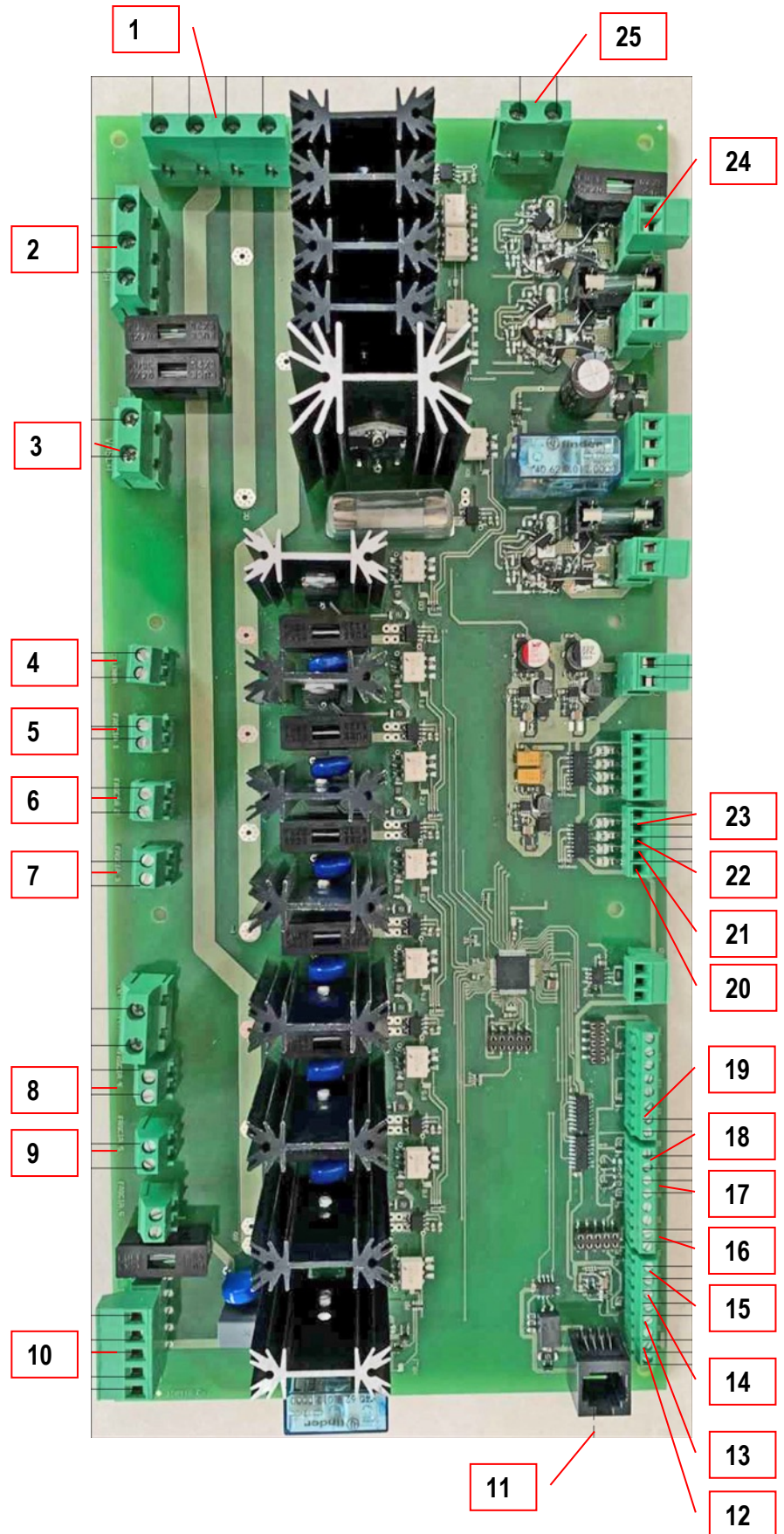

1.7. Details of the manufacturer

The machine described in this instruction manual was built by:

SELMi S.r.l.

Via Statale, 151 – 12069 – S. Vittoria D'Alba (CN) Italia
 Tel. 0172.479273 - 0172.479275 - Fax 0172.477814
 www.selmi-group.it - info@selmi-group.it

1.8. Identification plate of the machine (CE marketing)

There is a plate, similar to the one shown here, on the machine, indicating details of the manufacturer, the CE conformity mark and the machine's serial number. Always state this number when communicating with the manufacturer.



Example of identification plate on the machine structure

- TYPE
- SERIAL NUMBER
- YEAR
- WEIGHT

1.9. Identification plate of the CE marking electric panel (low voltage)

Example of identification plate on electrical panel. The correct data shown in the section on the machine's technical specifications.

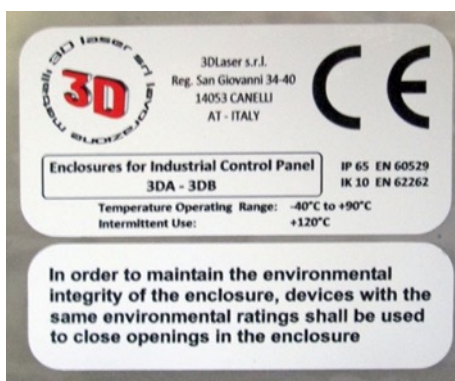

1.10. Inteded use

Chocolate mixers and melters TANK 400 Continuous chocolate mixer and melter. Entirely built in stainless steel AISI 304. The mixer can be operated in a continuous or intermittent mode with programmable temperatures and timed mixing. The heating of the tank and of the exit conduit are separately thermoregulated. Integrated pump for the supply of the relevant machines.

Warning

A use other than that specified is considered improper. The machine is intended for professional use only.

Attention

Do not place any small objects near the control panel or the tank: they could fall and enter the tank, which would contaminate the product.

1.11. Operating environment

To guarantee proper functioning the machine must be protected from atmospheric agents. Its ambient operational temperature should be between 15C° and 25C° with relative humidity not exceeding 70%.

The working environment must be clean, sufficiently illuminated and away from an explosive environment.

The environmental characteristics of the installation site are specified in section 4.

Attention

The machine's fixed guards have a variety of openings to allow the internal units to cool. When the machine is running, make sure that these openings are not covered by cloths or objects that obstruct proper air flow.

1.12. Noise level

The phonometric tests carried out on this specific machine model show an acoustic pressure lower than **70 dB(A)**.

1.13 Electrical and technical characteristics

Total weight	300 kg
Total power installed	9 kW
Voltage	380 V
Phases	3
Frequency	50Hz or 60 Hz
Protection	IP 65
Tank capacity	200 or 350 kg

* This data may change according to the installation conditions required under the contract. For the correct data please refer to the label located inside the electrical panel.

1.14 Dimensions

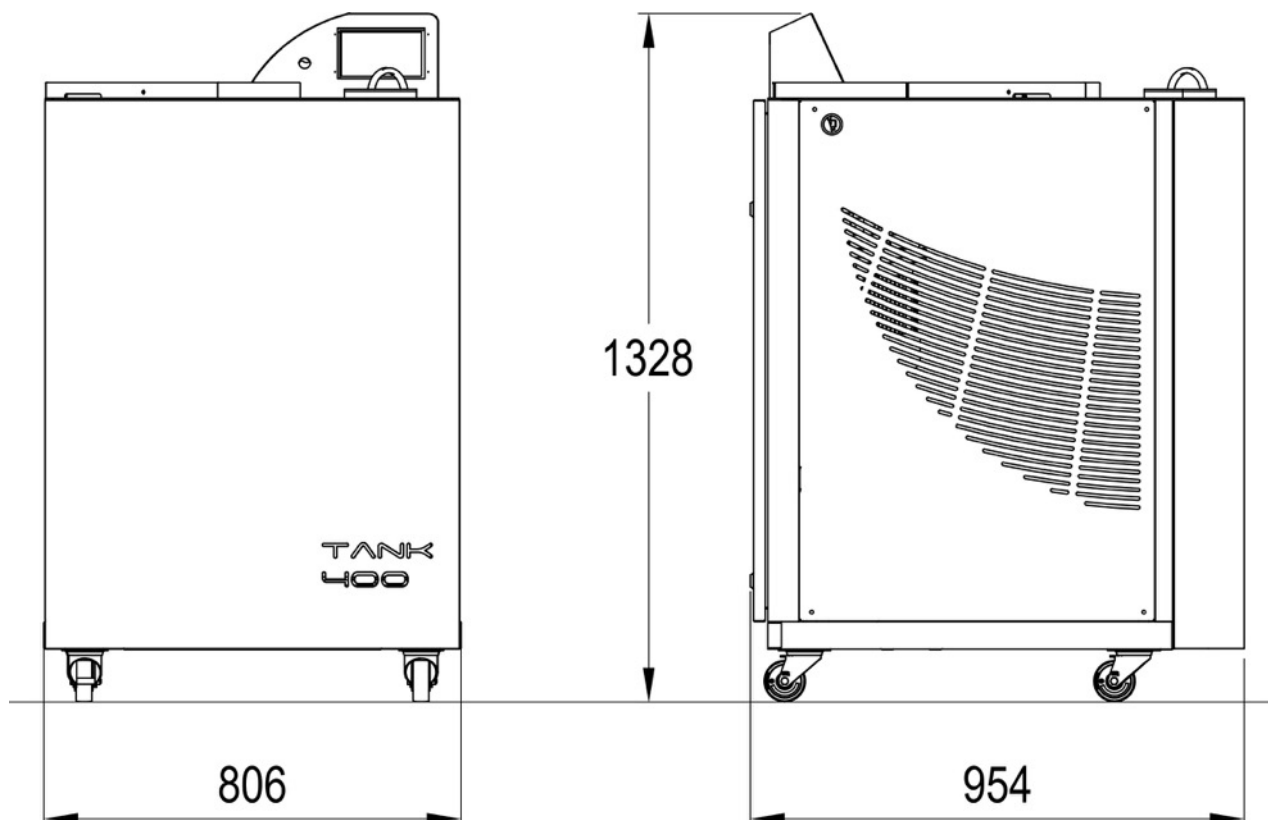

1.15. Storage

Remove the remaining product left in the machine following the instructions in the appropriate section. Stop the machine using the main switch and disconnect it from the electricity main. Move it to a spacious place (it is necessary to work all around the machine).

Clean the tank, the removable components (i.e. screw pump, mixer, nozzle) and the pipes as described in the appropriate section.

Attention

It is absolutely necessary to follow the instructions in order to insure the safety of the operators and to avoid damaging the machine's removable parts.

Use a brush to cover the movable components and the mechanical moving parts with a thin layer of food grade lubricant. This can later be removed with an alkaline de-greaser (Sodium Hydroxide) if the machine needs to be re-installed.

Carry out the same operation on the machine surfaces, taking care of avoiding the heating elements located in the inner part of the machine.

Gather the parts (use as reference the delivery packing list) and put them in the original packaging. Place packets of hygroscopic salt based on silica gel in the packaging.

Store all the parts in a sheltered place away from atmospheric agents and in temperatures from 0° C to 40° C. Cover the parts with nylon in order to prevent the accumulation of dust.

1.16. Disposal

Disposal will occur at the end of the working life of the machine, which under normal conditions of use and maintenance will be over ten years.

In the case of disposal all the components of the machine will have to be disposed of in adequate waste yards according to the legislation in force.

Before disposal it will be necessary to separate the plastic or rubber parts and the electrical and electronic material.

Environment

Parts made solely of plastic, aluminium and steel can be recycled in the appropriate collection centres.

According to the RoHS regulations electronic boards and electric material should be recycled separately in authorised collection centres.

1.17. Warranty

The manufacturer offers a warranty on this machine model for a period of 24 months from the purchase date, as shown on the fiscal document issued at the time the machine is delivered.

The warranty will be void if the machine is repaired by a third non authorized party or if fixtures and accessories not supplied by or recommended or approved by the manufacturer are used.

The warranty will also be void upon removal or alteration of the plate showing the serial number and other data.

Within the warranty period the manufacturer will repair or replace, free of charge, parts that are faulty due to manufacturing.

In case the repair has to take place at the manufacturer's site, the machine will have to be sent to the manufacturer in its original packaging.

Transportation expenses will be covered by the manufacturer during the warranty period.

The warranty does not cover the cleaning of the functioning parts.

Defects not clearly attributed to the material or the manufacturing will be examined. If the claim should turn out to be unjustified all repair expenses, changed parts and transportation will be charged to the buyer.

The warranty does not cover damage caused by the following:

- accidental damage during transportation
- damage due to lack of care or procedures carried out incorrectly
- damage due to improper use not conforming to the warnings of the user and service manual
- components subject to wear and tear; a detailed list is available in the components section.

Structural damage, modifications, improper alterations or repairs can affect the functioning of the safety mechanisms, thus making the declaration of conformity and warranty void. Alterations on the machine can be carried out solely by technicians authorised by the manufacturer.

1.18. Professional personnel qualified to operate the machine

The machine must only be used by authorized and purposely trained personnel; the same precautions are also applicable to personnel who carry out maintenance.

Personnel who do routine and extraordinary maintenance must be specially trained professionals; good knowledge of the machine is needed for extraordinary maintenance.

Attention

Do not permit others to approach the machine during its use or maintenance.

The following professional people, after having received all the necessary instructions, are the only ones allowed access to the machine:

Safety officer

The safety officer is responsible for protection and prevention of risks in the workplace, as is mentioned in European Directive 89/391/EEC (Safety in the workplace), introduced in Italy with the 12/11/1994 Legislative Decree.

It is the responsibility of the safety officer to make sure that all personnel who use/maintain the machine have received all the instructions regarding their relative roles contained in this manual.

Operator (user of the machine)

Operator trained and qualified for the use of the machine (working cycle, potential adjustments, etc.). He/she can only carry out the specific tasks described in this manual reserved for this role.

Mechanical maintenance technician

The technician is qualified to use the machine as the OPERATOR and furthermore to use it with the protection disabled, to attend to the mechanical parts for adjustments, maintenance and reparations.

He/she is not qualified to act on live electrical installations.

The mechanical maintenance technician must have a generic knowledge of the machine and a specific knowledge on this machine model.

Electrical maintenance technician

The technician is qualified to use the machine as the OPERATOR and furthermore to use it with the protection disabled, to attend to the adjustments and electrical installations for the purposes of maintenance and repair.

If qualified, he/she may work when the electrical panels, control devices, are live, provided he/she uses appropriate personal protective devices.

The electrical maintenance technician must have a generic understanding of the electrical panels and specific knowledge on the electrical panel and components of this machine.

Manufacturer

The manufacturer's personnel are qualified to perform all of the above-described operations.

Any operations not described in this manual may be performed ONLY by personnel authorized by the manufacturer.

2. Safety section

2.1. Safety information

Attention

The safety officer has the obligation to inform the workers on the risks related to the use of the machine.

Furthermore the employer must inform, educate and train the user according to statutory laws.

The lack of compliance with the basic norms or precautions could result in accidents during the functioning, maintenance or reparations of the machine. Accidents can often be avoided by acknowledging potential hazardous situations before they materialize. The operator must pay attention to the potential dangers and have the training, the competence and the necessary equipment to deal with these tasks correctly.

The manufacturer cannot be held responsible for accidents or damages resulting from the use of the machine by personnel not adequately trained or having used the machine improperly, as well as the lack of, even partial, compliance to the safety norms and interventions procedures contained in this manual.

The safety precautions and the warnings messages, the operator could be subject to accidents with serious consequences for himself and for other people.

In cases where tools, procedures, work methods or working techniques not explicitly suggested by the manufacturer are used, it will be necessary to make sure that no dangers are present for the individual carrying them out and to other alike.



Use exclusively original SELMI spare parts. The manufacturer will take no responsibility for accidents or damages in the case of use of non-original spare parts.

If a tool not supplied by the manufacturer is installed on the machine, the client needs to make sure that the norms stated in Directive 2006/42/EC are adhered to. If this new tool introduces new risks to the system then the new system must be re-certified. In any case the manufacturer cannot be held responsible for accidents or damages caused by the machine if it has been modified or equipped with non original accessories.

2.2. Safety limitations

Attention

The indications mentioned hereafter cannot completely safeguard from all dangers that one might encounter while using the machine; they must be used in conjunction with common sense and the experience of the operator, the only indispensable measures for the prevention of injury.

Every section has a list of specific safety measures for different operations. The safety measures mentioned here below are generic and should be followed for all procedures on the machine.

The responsibilities assigned to specific people concerning the use of the machine must be clearly defined as stated in the "Qualified Personnel" section.

Attention

The use of the machine is forbidden to personnel who have not been authorised or trained by the safety officer.

Consult the manufacturer before carrying out procedures that are not mentioned in this manual.

Prolonged overloads or anomalies can cause the electric motors and electrical appliances to overheat with resultant harmful fumes. In such cases immediately disconnect the machine from the mains and do not approach the machine until such fumes have been dispersed via adequate ventilation. In case of fires do not use water jets on the machine – use CO2 extinguishers instead.

The operator, any helping technician and the maintenance technician must use the appropriate personal protection equipment when working on the machine.

It is forbidden to climb on the machine.

Do not touch the electrical wires, switches, buttons etc. with wet hands.

The parts subject to wear and tear during the functioning of the machine must be checked and replaced as soon as they present noticeable signs of wear and tear.

The manufacturer has designed and built the machine to last for a reasonable time with the Client's normal conditions of use in mind; it is however necessary to periodically check the components and the structure of the machine, paying attention to any anomalous conditions, such as, for example, cracks or deformations. If necessary, contact the manufacturer to ask for a complete check of the machine.

Please consult Section 4 (Installation) for the working environmental conditions of the machine.

2.3. Safety symbols and plaques

The machine has a number of plaques with symbols and and/or safety messages stuck to it.

Attention

Make sure that all the safety messages are legible and in good condition.

Replace the damaged plaques with the new ones from the manufacturer. If a plaque happens to be on a part that is being replaced, make sure that a plaque is present on the new piece. For the cleaning of the plaques consult the appropriate section (6.3).

ATTENTION

THE PERFORMANCE OF WORK ON ELECTRICAL EQUIPMENT CONNECTED TO THE POWER SUPPLY IS STRICTLY FORBIDDEN

- ANY EXCEPTIONS MUST BE AUTHORISED BY THE EXECUTIVE MANAGER
- IN PARTICULARLY DANGEROUS SITUATIONS, ANOTHER PERSON MUST BE PRESENT IN ADDITION TO THE PERSON PERFORMING THE WORK

WORK MAY ONLY BEGIN WHEN THE SAFETY MEASURES HAVE BEEN IMPLEMENTED

IN OBSERVANCE OF PRESIDENTIAL DECREE 543 ON THE PREVENTION OF ACCIDENTS



(positioned on the door of the electrical panel)



Label indicating compulsory reading of the manual (positioned on the front of the machine)

2.4. Safety and protection devices

Attention

The components shown here are particularly important for the safety of the operator and the machine. In cases of malfunction or wear they must be replaced with spare parts supplied or authorized by the manufacturer.

While the machine is in use all the protection devices must be correctly installed.

The safety devices present on the machine are:

- *Mushroom emergency button with mechanical unblock mechanism.*



There is an emergency stop mushroom button on the machine. Pushing it cuts voltage to all live parts by means of appropriate devices. To reset it, release the emergency button by turning its head and then push the RESET button shown in the photo.

Before starting every shift, press it to make sure that it works properly.

- *Electric panel safety microswitch*



Within the electrical panel there is a safety microswitch which disconnects the voltage every time the panel is opened for maintenance interventions.

Attention

Periodically check that the safety microswitch is working properly.

If faulty, please proceed immediately with its replacement.

- Fusibles



Warning

If fuses keep blowing it may be an indication of a fault of the devices installed on the machine; in such cases contact Technical Support.

- *Protective devices*

The machine is equipped with protective plates (Pg. 2 points 9, 10 and 16) that can be removed with a tool to allow access to the inside of the machine in order to carry out maintenance operations.

The fixed protective plates are screwed into position and can be removed with the appropriate tool; if the screws are removed the fixed protective plates will not remain in place and must be placed on the floor.

All the protective plates have smoothed and rounded edges for the safety of the exposed individual and of the operators.

The protective plates have loss-proof screws that remain attached to the plate when it is removed from the machine.

To remove the protective plates see section 6.5.

Attention

Do not switch the machine on if the protective panels are removed or not correctly fixed into position with the appropriate screws.

Do not forget to remove cloths, keys or utensils used for the maintenance operation from within the machine.

Before closing with the protective panels and switching on the machine check carefully and if necessary remove any extraneous objects which may be present inside the machine.

All protection and safety devices must always be kept in perfect working conditions. If faulty, they must be immediately repaired or replaced.

The replacement, disengagement, partial or total removal of the protective plates, safety devices and protective structures must only be carried out during maintenance operations. This also applies to the safety plaques attached to the side of the machine.

2.5. Client's safety measures

The client must arrange for the following safety measures to be in places:

Provision of an adequate location for installation, paying particular attention to the characteristics below:

- Adequate flooring
- Normal and emergency lighting
- Adequate ventilation
- Clearly signposted emergency exits
- Provision of mains voltage connection with associated safety devices, conforming with the norms in force and the characteristics of the machine
- Adequate means for the collection and subsequent disposal of residues, even hazardous or special ones (oils and grease, broken or waste material, etc.).
- Adequate fire safety systems and equipment
- Prohibition of entry into the installation area to non authorized personnel

The customer must also provide for:

- Training of the operators and the maintenance technicians
- Training for the operators on the basic functioning of the machine and emergency devices
- Provision of personal safety equipment to protect the operator and the hygiene of the product
- Checking the qualifications of external maintenance technicians potentially called to work on the machine
- Keeping of a maintenance log book

The employer is also responsible for checking that the operators correctly carry out the procedures explained in this manual.

2.6. Personal protection equipment

The operators who carry out functions on the machine must receive appropriate instructions on the use of personal protection equipment such as shoes, gloves, etc... which will protect them from residual risks derived from the execution of various activities. The operators must furthermore be equipped with protection equipment for hygiene purposes (caps or hair nets, gown, etc...).

If the noise level in the working environment surpasses 85dB(A) appropriate ear protection must be used.

Warning

The clothing of whoever operates or carries out maintenance on the machine must conform to the essential safety requirements defined by European directive and the laws in force in the country in which the machine is installed.

Attention

During maintenance operations individuals must wear adequate clothing to prevent the occurrence of accidents.

In order to avoid mechanical risks such as snagging or dragging, it is prohibited to wear particular objects such as bracelets, watches, rings or necklaces during the working cycle and during maintenance operations.

2.7. Residual risks

The accurate risk analysis carried out by the manufacturer and archived in the technical file has eliminated most of the residual risks, which are nevertheless present during the use of the machine, to acceptable levels.

The manufacturer's recommendation is to meticulously adhere to the instructions, procedures and recommendations contained in this manual.

Attention

It is strictly prohibited to carry out any type of mechanical or electrical modification so as not to create added dangers and unforeseen risks.

Attention

During cleaning and maintenance operations and during the work cycle, do not allow the product inside the tank to come into contact with water or other fluids.

Attention

If the machine remains unused for long periods of time please take note of the expiry date of the product remaining inside the machine. Upon restarting the processing only insert new chocolate if the product already in the machine has not expired. If the old product has expired, proceed to empty and clean the machine before inserting the new product.

Attention

It is expressly forbidden to remove the safety and/or warning plaques placed on the machine.

The manufacturer will not take any responsibility on the safety of the machines if this is not observed.

Attention

Keep the machine with the residual chocolate inside the tank in an adequate environment with temperatures ranging from 10 °C to 25 °C.

The residual risks present on the machine are:

Risks during machine transportation

It is recommended to fasten the machine, or its parts, at the dedicated locations and lift it with appropriate means to the minimum permitted height, proceed at low speeds and make sure that the people helping with the moving are at a safe distance from the moving object. Before moving the machine make sure that the passage is clear and that there are no objects placed on the machine. It is important that the means of support and transportation is controlled by a person qualified for such a role, so as to avoid unforeseen movements which may be dangerous to the people in the vicinity who are helping with the moving.

Risks of faults to the circuits of signalling, safety, protection and emergency stop

In the case of a circuit fault, the safety and signaling circuits, the anti-injury protections and the emergency stop can lose their effectiveness, therefore it is asked that their functionality is periodically checked.

Identified residual risks and information plaques

The manufacturer has placed on the machine danger and/or warning plaques, based on the residual risks, with pictograms in compliance with the norm pertaining to the display of graphic symbols on the machine.

The user should immediately replace these plaques if they are not clearly legible.

Risk to life (electrocution)

Before commencing work on any electrical appliance it is necessary to disconnect the machine from the mains. If it were to become necessary to work within the electric panel by bypassing the electricity cut off devices, then the work must be carried out exclusively by specialised personnel.

Risk of spreading fire

In case of fire never use jets of water in the vicinity of the apparatus. Disconnect all connections to the mains and use the appropriate CO2 extinguishers located in the building.

2.8. Applied Directives

The following directives apply to the machine described in this manual:

- 2006/42/EC machinery Directive
- 2014/30/UE Directive for electromagnetic compatibility
- 2014/35/UE low voltage Directive

And the regulation:

- 1935/2004 EC regulation for materials in contact with foodstuffs

2.9. Harmonized technical norms

The machine was designed and tested to conform to the “essential requirements to health and safety” present in attachment I of European Directive 2006/42/EC.

The norms used as reference for the design, the realization and the testing of the machine are listed in the technical file archived by the manufacturer. **3.**

Moving and transportation section

3.1. General norms

Before moving the machine always check the weight and general instructions shown on the packaging. Personnel not responsible for the movement of the machine must not remain in the area needed for movement.

3.2. Packaging

The machine is delivered on a platform, secured by means of straps and placed inside a cardboard packaging which is also secured to the platform by means of straps. An example of the machine packaging is shown in the picture below.



Instructions for transportation are on the sides of the packaging.

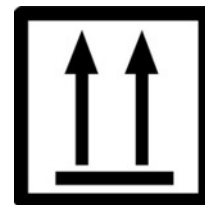

The first symbol shows the correct upright position of the packaging;



the second symbol shows that the packaging must be protected from the rain.



the third symbol shows that the content of the packaging is fragile and must be handled with care. On two sides of the packaging there is a device called "TILTWATCH", which can determine if the packaging has been tilted to such an extent that the content may have been damaged; it is necessary to pay attention to

the instructions given on the adhesive label. If the machine has been excessively tilted during transportation (the dot at the centre of the TILTWATCH device will be red) some components could have been damaged.



Attention

The manufacturer's warranty does not cover damage during transportation; the buyer should follow the instructions on the adhesive label in order to avoid disputes.

3.3. Transportation

To transport the machine it is necessary to use a suitable vehicle equipped with a platform to lift the load; the platform must be adequate for the weight of the machine, which is stated in the technical characteristics section (section 1.13).

When the machine, still in its packaging, is in the body of the lorry, it can be carried to the lifting platform only by means of a manual transportation trolley for euro pallets.

The lifting platform has to be equipped with side rails in order to prevent the machine from falling when it is still high off the ground.

The machine can be lowered to the ground from the platform only after having lowered the manual trolley. The machine should be lowered slowly from the platform, avoiding shaking and sudden stops which could cause a loss of stability.

After having completed the unloading procedures, the machine should be moved exclusively by means of a manual transportation trolley adequate for euro pallets; the platform should only be lifted to the height needed to move the machine.

Before moving the machine verify that the passage to the final destination is clear.

Attention

Do not go on very steep ramps which could cause the loss of control of the trolley.

3.4. Removal of the packaging

Cut the straps that anchor the cardboard to the platform; remove the cardboard and put it out of the way.

Cut the straps that hold the machine to the platform, remove the machine's plastic cover and unravel the accessories provided.

Carefully lift the front of the machine and remove the wooden slat blocking the front wheels; subsequently remove also the wooden slat blocking the rear wheels by lifting the back of the machine.

Very carefully lower the machine from the platform.

Note

Keep the original packaging; it may be necessary to use it if the machine needs to be sent to the manufacturer for extraordinary maintenance or repairs.

Before moving the machine always check the weights and the general indications on the packaging.
When moving with the forklift, lift the load 200 mm from the ground and tilt backwards.

A) Forklift fork boxes..

Machine weight Kg 180

When lifting loads, take into account the height of the environment in which you are working.
Go back down the slopes; drive downhill with the forward load decreases the stability of the trolley.
Before starting the movement, make sure that the area of passage is clear and there are no objects furniture on board the machine.
Ropes and chains must be protected from sharp edges using angles, corner guards or other protections (rags or wood).
Before moving the machine, some preliminary preparation operations must be carried out:

- check that the machine is released from floor;
- remove the removable parts;
- block all moving parts to avoid damage them during transport;
- use lifting equipment suitable for the declared weights.



4. Installation section

4.1. Positioning

Warning

Before positioning the machine check that the machine, the associated accessories and the parts supplied separately have not been damaged during transportation.

It is the task of the Client to make sure that the strength of the supporting surface, at the point of installation, is adequate for the weight of the machine.

The flooring at the point of installation must be sufficiently level.

Isolate the machine from any potential vibrations coming from other nearby machinery.

In the case where the machine or any of the associated accessories are found damaged it is important to alert the manufacturer of the found anomaly so as to agree on the actions to be taken.

Attention

The machine must be placed on a level surface; for the other environmental requirements necessary for optimal functioning of the machine please see sections 1.11 and 2.5..

4.2. Electrical connections

Attention

The connection of the machine to the electrical system must be carried out by personnel observing the legislation in force; the characteristics of the electrical connection must be compatible with the electrical specifications of the machine which can be found in the relevant section or on the opposite plaque on the door of the electric panel.

Attention

If the machine has been purchased to be powered by a three phase line, make sure that in the socket there is a connection to the neutral wire. This is necessary for the functioning of the machine.

Attention

Before starting any procedure make sure that there are no objects inside the tank.

Attention

This operation should be carried out by a technician or by a maintenance electrician.

Connection to the pneumatic system must be made using a quick fitting with closure valve; this fitting must be compatible in size with that installed on the machine.

The first time the machine is used, the pneumatic connection must be made by qualified personnel.

When connecting the machine to the electrical system via a three phase line, check the direction of rotation as follows:

- 1) plug in the machine
- 2) verify that the emergency stop button is not pressed and, if this is the case, reset it
- 3) close the upper protective panel
- 4) Choose the manual mode
- 5) Start the mixer

Warning

The machine can work only if the tank mixer is rotating anticlockwise when observed from above.

If the rotation direction is wrong, it is necessary to act as follows:

- 1) Stop the mixer
- 2) turn off the machine by pushing the red button on the main switch
- 3) disconnect the plug, open it and swap the position of the two black wires n°2 with n°3, paying attention not to disconnect the other wires

Attention

This operation should be carried out by a technician or by a maintenance electrician.

If the mixer is rotating in the correct direction carry out the following steps:

- 1) close the upper protective panel
- 2) Choose the manual mode
- 3) Start the mixer

After checking the direction of rotation, it is necessary to check that the pneumatic system has been correctly connected to the machine with the quick fitting. After completing these checks, continue the installation operations as described in the following sections.

Warning

Don't run the pump without product inside the tank.

4.3. Installation of the machine

After carrying out the positioning operations and connection to the electricity main, proceed with the following operations:

- Cleaning the supplied accessories

Attention

Make sure that no objects used during installation have been left in the tank; if so, remove them.

4.4. Commissioning

Check that all of the above-described procedures were done correctly.

Check that the emergency button is not pushed; if it is, release it.

Power-on the machine by pressing the button on the main switch. The display on the control panel will light up to show that the machine is in STAND-BY.

Check that the safety and emergency protections and control devices are working correctly.

Make sure the work zone is free of all objects not needed for work and that there are no oil stains on the floor.

4.5. Installation of the delivery pedal chocolate

To connect the pedal it will be necessary to insert the plug (1) in the socket located at the back of the machine.



5 - OPERATION SECTION

TOUCH SCREEN PAGES DESCRIPTION

HOME PAGE:

When you connect the machine to the power supply, the following start page appears on the touch screen display

To access the next screen, press somewhere on the screen to go to the workpage



WORK PAGE

HOME button

Mixer ON - OFF button

Auto ON - OFF button. When it's grey is turned OFF

Pump ON - OFF button. DON'T RUN THE PUMP WITHOUT PRODUCT INSIDE THE TANK

TEMPERATURE CONTROL PANEL

Tank temperature main control. Press the blue temperature to set. On the right the READ temperature

Pump temperature main control. Press the blue temperature to set. On the right the READ temperature

WORK PAGE WHEN THE SENSOR LEVEL IS CONNECTED BUT NOT ENABLED

PRESS ON HTE BUTTON TO ENABLE THE SENSOR FEED

WORK PAGE WHEN THE SENSOR LEVEL IS ENABLED

TEMPERATURE CONTROL PAGE

This page shows all the temperatures for the resistances:

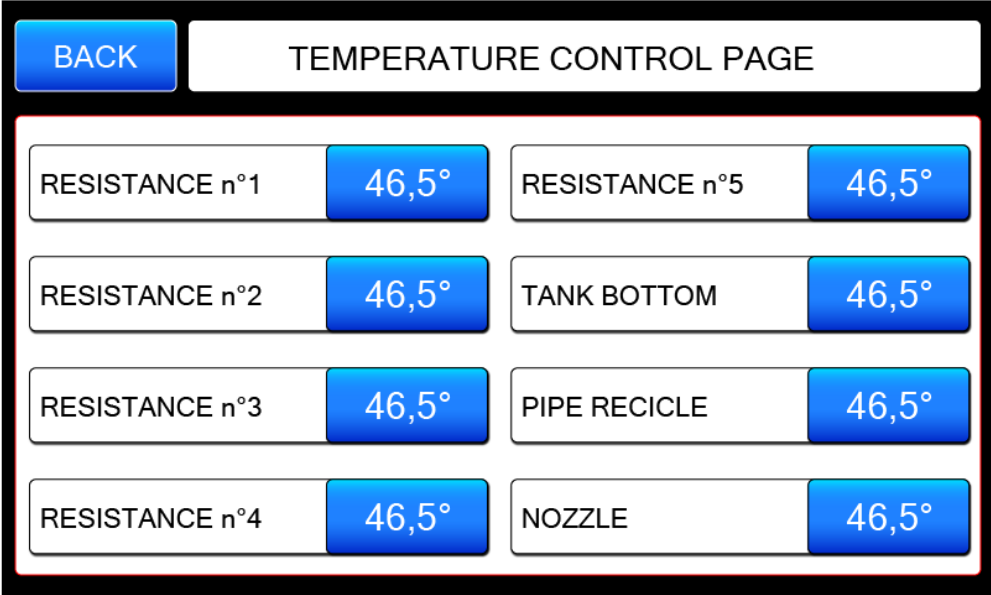

The screenshot displays a control interface titled "TEMPERATURE CONTROL PAGE" with a "BACK" button. It shows temperature readings for five resistances and three other components, all at 46,5°. The interface is annotated with red boxes on the left and right sides, mapping the labels to the corresponding data points in the screenshot.

Component	Temperature
RESISTANCE n°1	46,5°
RESISTANCE n°2	46,5°
RESISTANCE n°3	46,5°
RESISTANCE n°4	46,5°
RESISTANCE n°5	46,5°
TANK BOTTOM	46,5°
PIPE RECICLE	46,5°
NOZZLE	46,5°

Annotations on the left side of the screenshot:

- tank band n°1
- tank band n°2
- tank band n°3
- tank band n°4

Annotations on the right side of the screenshot:

- tank band n°5
- tank bottom
- recicle pipe for product exit
- nozzle product exit point

HOW TO WORK WITH THE MACHINE

1. Connect the machine with the electrical supply
2. Insert the product into the tank
max 200 kg for TANK 200 - **max 400 kg** for TANK 400
3. Choose the working between mixer working AUTO or continuous.

AUTO:

Use AUTO mode when it's not necessary that the mixer will run in continuous;

For example 30 minutes of working, then 30 minutes is turned off.

In this way it's possible to save electricity and mixer motor work.

1. Set the working time
2. Set the pause time
3. Press START

The machine will work and then pause for the time values that are set.

TO USE THE CHOCOLATE OF THE MACHINE

Work page. Press pump button and the product will flow from the exit point to fill for example any tempering machine connected with a pipe from the tank nozzle to the tempering machine tank.

PUMP



To take some chocolate for any use you can use the pedal. Press the pedal to activate the pump and the chocolate will flow from the pipe exit. Release the pedal to stop chocolate flow.

SENSOR FEED LEVEL

If you have the sensor feed level connected and placed into a tempering machine, press on the disable button to ENABLE. the chocolate will flow and feed automatically the tempering machine tank every time is necessary



CLEANING AND MAINTENANCE

1. Place a container in order to receive the product.
2. unscrew the pipe cover
3. Activate the pump to empty the tank.
4. Wait until the product is unloaded.



5.4. Position of the user

During the working cycle a sole operator is needed located in front of the working panel with easy access to the emergency button.

5.5. Involuntary electrical interruptions

If the voltage supply were to fail during the working cycle, restart the machine as described in section 5.3.1.

5.6. End of the working cycle

Upon completion of the machine operating cycle, after emptying it as described in section 5.3.2., simply place the circulation tube back in position and close the upper protective panel.

The machine can be placed in stand-by or be turned off using the main switch.

6. Maintenance section

6.1. General information

Attention

The product present in the tank or internally to the machine must NEVER come into contact with water or other liquids: this may lead to the formation of moulds and bacterial loads.

Attention

If a bacterial presence is found on the product derived from the processing carried out with this machine model it will be necessary to stop production immediately and contact the manufacturer for the disinfection procedures.

Before carrying out maintenance or cleaning procedures on the machine, cover the tank with the supplied lid.

Never clean or lubricate components in motion.

Warning

Extraordinary maintenance on the machine is exclusively carried out by the technicians approved by the manufacturer.

The training course carried out only gives the client the base instructions for ordinary maintenance. The manufacturer suggests carrying out a full service every two years to guarantee the safety conditions.

Note

The maintenance technician must note on an appropriate logbook all the interventions carried out on the machine.

This section describes the ordinary checking and maintenance procedures needed to guarantee the correct functioning of the machine.

Any other intervention that may be necessary to eliminate anomalies or faults must be expressly authorized by the manufacturer.

For major repairs it is recommended to turn to the manufacturer whose specialized personnel, possessing the technical expertise acquired from the original manufacturing in the factory, are always reachable and able to intervene quickly.

For maintenance or replacement of commercial components installed on the machine keep to the instructions provided directly by the manufacturers.

Such instructions are normally attached to the components or obtainable via catalogues or manuals provided by the manufacturers.

Environment

The components replaced during maintenance operations must be disposed of according to the laws in force concerning waste materials. If necessary, they can be sent to the manufacturer, who will dispose of them in the most appropriate manner.

6.2. General safety practice

Attention

Before starting a maintenance procedure disconnect the machine from the mains and put in place all the necessary safety measures.

Attention

During maintenance procedures place on the machine, preferably on the control panel but in any case in a clearly visible location, a sign with the text: "MACHINE UNDER MAINTENANCE, DO NOT SWITCH ON".

Maintenance work must be carried out by specialized technicians who are trained in specific sectors, which for this machine are:

- mechanical maintenance technicians;
- electrical maintenance technicians.

It is the duty of the Safety Officer to ascertain the professionalism and competence of the maintenance technicians.

Before starting a maintenance procedure the safety officer must:

- 1) Clear the working area of extraneous materials and people.
- 2) Make sure that the necessary tools are conveniently available to the maintenance technician and that they are in good condition.
- 3) Make sure that the lighting is sufficient and provide, if necessary, portable low voltage lights.
- 4) Make sure that the maintenance technician is equipped with the necessary approved personal protection equipment for the specific operation (gloves, safety glasses, shoes, etc.).
- 5) Make sure that the maintenance technician has carefully read the instructions contained in this manual and has excellent knowledge of how the machine works.

6.3. Cleaning external parts

Attention

The product in the tank and in the machine must NEVER come into contact with water or other liquids: this may lead to the formation of moulds and bacterial loads.

Attention

Use appropriate personal safety equipment while carrying out the cleaning of the machine.

Clean persistent stains with dry and soft clothes that do not fray or use flexible bristle brushes.

If the stains are incrustated and hard to remove with dry clothes or brushes use a liquid solvent appropriate for use in an alimentary environment. Avoid the use of flammable or toxic solvents.

Clean the signalling plaques with a cloth, soap and water or any other mild liquid; avoid using chemical solvents.

Before beginning and at the end of every maintenance operation it will be necessary to vacuum away the dust and other residues, recurring to using appropriate solvents if necessary but avoiding the use of compressed air jets which can create zones of dirt accumulation and may cause injury to the individuals present in the area.

Warning

The operation explained in this paragraph is delicate and requires particular attention; the manufacturer can supply the instructions necessary to correctly perform the operation.

6.5. Maintenance of mechanical parts

If detailed diagrams are not available take note of every item and mark its location so as to avoid errors in reassembling.

Always use spanners of the correct size.

Immediately replace screws or bolts which show signs of wear on the threads and the heads. When screwing and unscrewing do not use the spanners in conjunction with extensions to augment the torque. If dynamometric spanners and special tools are used verify that the calibration is appropriate for the component.

Special care must be taken when using pneumatic or hydraulic tools.

Before dismantling heavily oxidised components spray them with deoxidising agents.

Before reassembling cover thinly with oil all the coupled surfaces.

During reassembly pay particular attention to anti-slip devices used by the manufacturer (flat washers, elastic washers, etc.), always replacing the worn out elements.

The ring nuts and anti-slip ring nuts with plastic blocking rings must be replaced at every reassembly since the fatigued material will deform and lose its functionality.

Attention

During maintenance procedures always use appropriate personal protection equipment.

6.5.1 Removal of the fixed lateral and rear fixed protective panels

Attention

Do not start the machine with the protective panels removed or incorrectly screwed into place.

Do not forget cloths, spanners or other maintenance tools inside the machine.

In order to remove the front lateral fixed protective panels follow this procedure:

- 1) Disconnect the electrical power plug and the pneumatic power
- 2) Position the machine in a spacious area so as to allow easy access.
- 3) Using both hands lift the panel out of position and place it, preferably horizontally, on the floor or on a level surface. Make sure that it is not in the way and that it cannot fall or create risks to others working in the vicinity of the machine

In order to remove the rear fixed protective panel follow this procedure:

- 4) Disconnect the electrical power plug and the pneumatic power
- 5) Position the machine in a spacious area so as to allow easy access.
- 6) Prepare the machine by closing the upper protective panel
- 7) Identify the location of the rear panel fixing screws (B)
- 8) Loosen with an appropriate tool (not supplied by) all fixing screws of the panel which needs to be removed
- 9) Remove the screws one at a time, keeping the panel in place until all screws are removed
- 10) Using both hands lift the panel out of position and place it, preferably horizontally, on the floor or on a level surface. Make sure that it is not in the way and that it cannot fall or create risks to others working in the vicinity of the machine

6.6. Maintenance of electrical system

Attention

Before taking any action on electrical components disconnect the machine from the mains.

Always carefully check the isolating covers, the clamps and the grip of the sheaths; seal gaskets cannot guarantee the IP level of protection declared by the manufacturer if they are not correctly positioned or if they are damaged.

Replace sheaths and cables if their isolating covers are ruined or damaged.

Check and restore, if necessary, the identification labels and stickers of the wires and of the components keeping to the indications shown in the electrical diagrams.

Make sure that the identification plate of the electric panel (see section 1.9) and the adhesive electric hazard plaque (see section 2.3) are perfectly legible and firmly attached; otherwise replace them by requesting new ones from the manufacturer.

The replacement of faulty control components must always be carried out according to the norms in force, using components with technical characteristics complying with those of the components that need to be replaced.

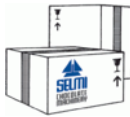

Use exclusively original SELMI spare parts

The manufacturer will take no responsibility for accidents or damages in the case of use of non-original spare parts.

6.6.1 Disconnection and reconnection of the motor

If the motor needs to be replaced an electrical technician will need to intervene. He will firstly have to disconnect the damaged motor and then connect the new motor.

Follow these steps to disconnect the motor:

- 1) Remove the lateral fixed protective panels following the instructions given in section 6.5.1
- 2) Remove the screws of the connection terminal protective box
- 3) Disconnect the wires paying attention to the terminal each wire is connected to. You will need to remember this when you come to reconnect the wires
- 4) Free the cable from the cable holder that holds it to the motor and pull it out

Attention

Never connect the power supply when one or more of the electrical components of the machine are disconnected and the conductors are not correctly isolated.

To connect the new motor follow these steps:

- 1) Make sure that the electrical characteristics of the new motor are compatible with the original one's
- 2) Unscrew the protective box of the connection terminal
- 3) Reinstall the motor power cable into the appropriate cable holder
- 4) Tighten the cable holder until it has a good grip of the cable, paying attention not to use too much force, as there is danger of damaging the cable or the cable holder
- 5) Reconnect the wires into the connection terminal
- 6) Remount the protective box of the connection terminal and fix it in place with the screws.

6.6.2 Replacement of fuses

To replace the fuses act as follows:

- 1) Unplug the machine
- 2) Open the electric panel by releasing the lateral hooks
- 3) Remove each fuse from the power board and individually check their continuity until the faulty one is found. Remove only one fuse at a time; once checked, if the fuse is not faulty, put it back in place before removing the next one.
- 4) Replace it with a new fuse having the same electrical characteristics and dimensions
- 5) Check that the fuse caps have been correctly put back on
- 6) Close the electric panel and check that the machine is working correctly

Warning

When checking the continuity of the fuses make sure that they are not on a conducting surface.

Warning

Repeated blowing of fuses could be caused by problems related to devices installed on the machine; in this case contact Technical Services.

6.6.3 Replacement of the display board

To replace the display board follow this procedure:

- 1) Unplug the machine
- 2) Open the electric panel
- 3) Remove the board connection adapter, taking care to mark the positions of the cables
- 4) Unscrew the display board and remove it
- 5) Slot in the new display board and tighten it into place as it was originally.
- 6) Reconnect the wires to the probes, making sure to reinsert the wires in the correct terminals and tighten the screws
- 7) Reinsert the display board connecting cable

The electronic board is sensitive to static discharges; we suggest handling it with caution, avoiding touching the printed circuit tracks.

6.6.4 Replacement of the power board

When replacing the power board (see photo on page 6) follow these steps:

- 1) Unplug the machine
- 2) Open the electric panel by using the provided key
- 3) Remove the plug-in terminals from the power board along with the display board connecting cable
- 4) Disconnect the wires from the screw terminals, labelling them in order to be able to reconnect them correctly
- 5) Unscrew the power board and remove it, paying attention not to move the spacers that keep it separated from the metallic casing of the electric panel
- 6) Slot in the new power board and tighten it into place as it was originally
- 7) Reconnect the wires into the screw terminals, paying attention not to invert their original positions
- 8) Reinsert the plug-in terminals correctly
- 9) Reinsert the display board connecting cable

The electronic board is sensitive to static discharges; we suggest handling it with caution, avoiding touching the printed circuit tracks.

6.7. Components subject to wear and tear

Attention

Components subject to wear and tear due to their function must be periodically checked and replaced when they show noticeable signs of wear.

The manufacturer has designed and built the machine to last for a reasonable amount of time taking into consideration its intended use; it is nevertheless necessary to periodically carry out checks to verify the state of the components subject to wear and tear.

If structural deformations or fissures in the metallic components or in the soldering are found, immediately contact the manufacturer's customer service; the expert technicians will help you to take the necessary steps.

Due to their manufacturing properties, heating elements undergo a reduction of their isolating properties over time, particularly when exposed to a high level of humidity. Periodically check the functioning of the circuit breaker, provided for the protection of the machine.

All electrical components having mechanical moving parts during the working cycle (buttons, relays, etc.) are guaranteed by the manufacturer for a high, but always limited, number of cycles.

Periodical cleaning of the inner part of the electric panel prevents these elements from being subject to further mechanical fatigue.

6.8. Planned preventive maintenance

Thanks to the correct use of the machine and to the appropriate planned preventive maintenance it is possible to obtain the highest reliability from the machine at a minimum maintenance cost. Furthermore, through periodic checks, mechanical or electrical faults will come to light before these cause damage to the machine or pose risks to personnel.

Note

Strictly respect the maintenance time intervals and space them out according to the specific necessities in relation to the productive cycle of the machine.

Here below is a list of periodic checks suggested by the manufacturer:

Before and at the end of each working cycle:

Cleaning of the external parts of the machine (see section 6.4)

Before starting each working cycle:

Check that the emergency stop button is functioning correctly: press the emergency stop button while the machine is switched on and check that the main switch trips, cutting off the power to the machine.

Check that the grill safety micro switch is functioning correctly: lift the grill while the machine is switched on and check that the main switch trips, cutting off the power to the machine.

Every month:

Check the state of the internal components of the machine: remove one of the lateral fixed protective panels and check that there are no signs of humidity inside the machine induced by other nearby machines.

Every six months:

Check that the safety micro switch of the electric panel door is functioning correctly: open the door of the electric panel while the machine is switched on, check if the main switch trips, cutting off the power to the machine.

Check the state of the mechanical fixings of the internal components: remove the lateral and rear fixed protective panels and check, by using the appropriate tools, that the components' fixing screws are not loose.

Warning

The manufacturer suggests carrying out a full service every two years to maintain the safety aspects of the machine over time.

Note

The machine is for professional use: it is therefore necessary to strictly respect the legislation in force regarding the periodic checks to the electrical circuits.

The manufacturer recommends the logging of all planned maintenance and extraordinary interventions, including dates and reasons for the interventions.

A		B		C		D		E		F																
0		1		2		3		4		5																
6		7		8		9																				
<p>Progettazione e Costruzione Macchine</p> <p>Schema Elettrico</p> <p>TANK 200/400 MY 2019</p>																										
<div style="border: 2px solid black; padding: 10px; width: fit-content; margin: 0 auto;"> <p>COMMESSA</p> <p>2019_06_001</p> </div>																										
<table border="1" style="margin: 0 auto;"> <tr> <td>RATED VOLTAGE</td> <td>400</td> <td>V</td> </tr> <tr> <td>PHASES</td> <td>3PH+N+Pe</td> <td></td> </tr> <tr> <td>FREQ.</td> <td>50</td> <td>Hz</td> </tr> <tr> <td>FULL LOAD CURRENT</td> <td>16</td> <td>A</td> </tr> <tr> <td>DRAW NUMBER</td> <td>2019_06_001</td> <td></td> </tr> </table>												RATED VOLTAGE	400	V	PHASES	3PH+N+Pe		FREQ.	50	Hz	FULL LOAD CURRENT	16	A	DRAW NUMBER	2019_06_001	
RATED VOLTAGE	400	V																								
PHASES	3PH+N+Pe																									
FREQ.	50	Hz																								
FULL LOAD CURRENT	16	A																								
DRAW NUMBER	2019_06_001																									
REV		MODIFICA		DATA		FIRMA		APPR		DATA																
										17-07-2019																
										DISEGN																
										VISTO																
										APPR																
										SOST. IL :																
										SOST. DA :																
										FILE :																
										TANK_200/400																
										MY_2019																
										Copertina																
										2019_06_001																
										=																
										+																
										FG 1																
										F.S. 2																

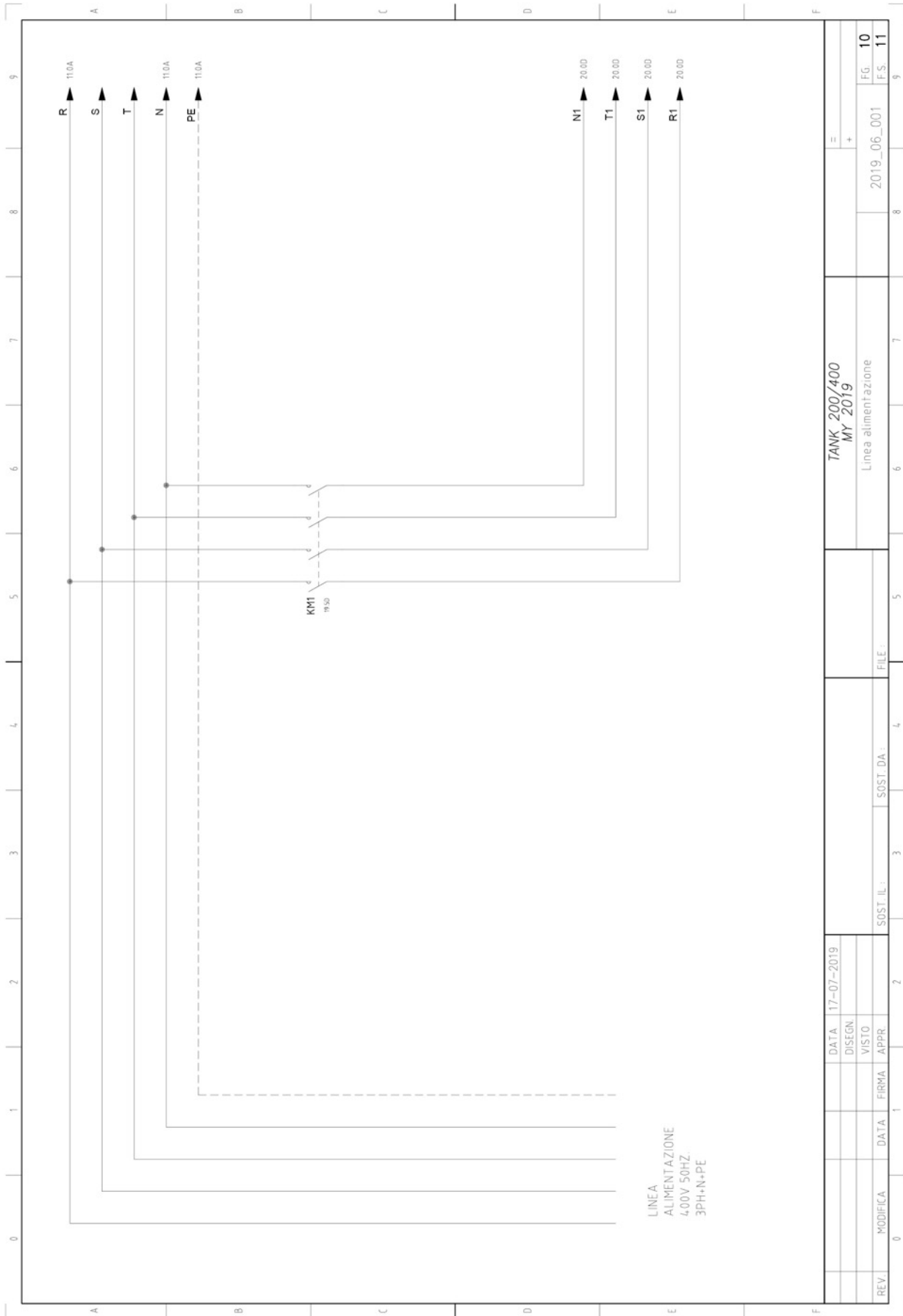

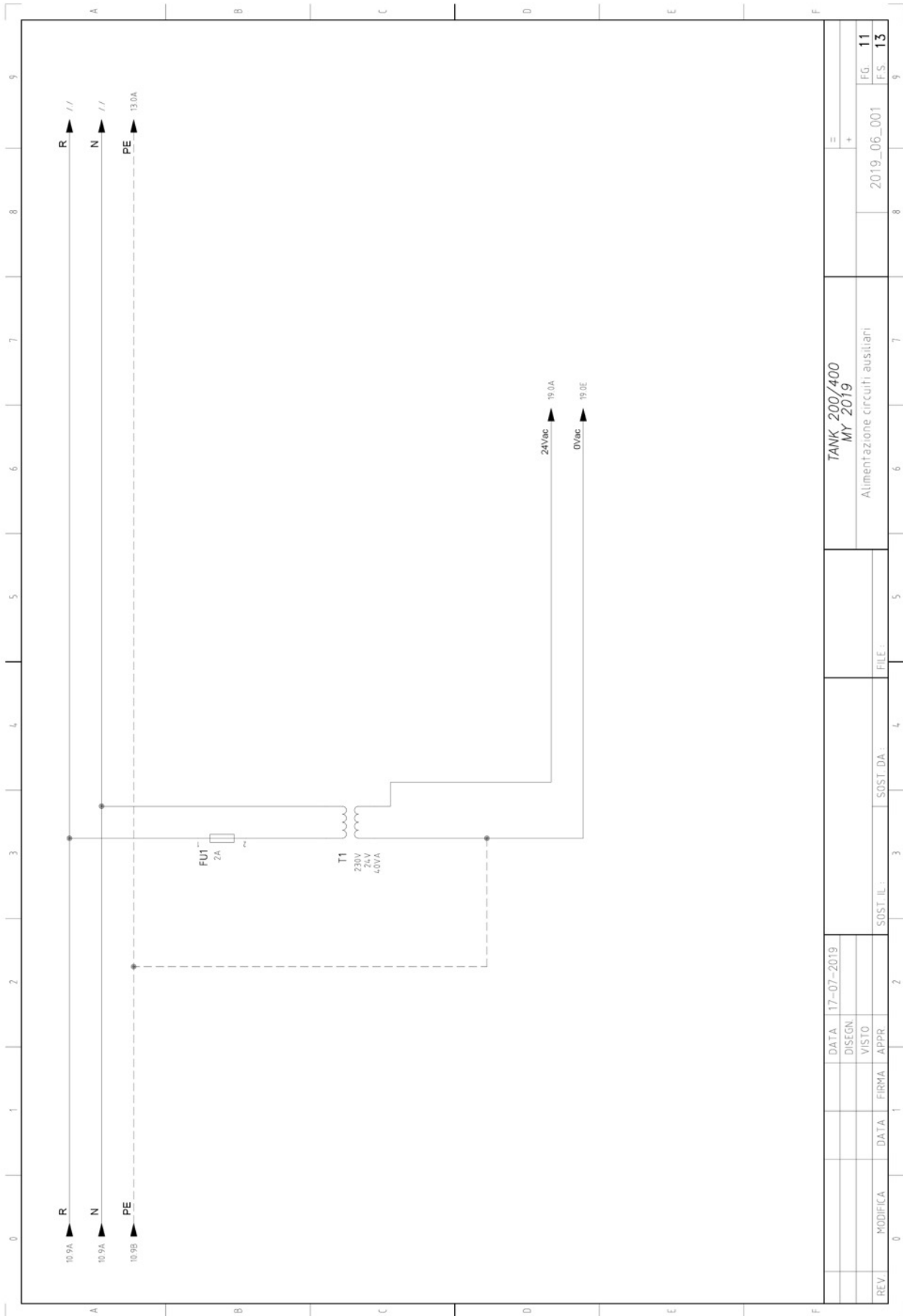

REV.	MODIFICA	DATA	FIRMA	APPR	SOST. IL.:	SOST. DA	FILE	TANK_200/400 MY 2019 Alimentazione circuiti ausiliari	2019_06_001	FG. 11 F.S. 13
------	----------	------	-------	------	------------	----------	------	---	-------------	-------------------

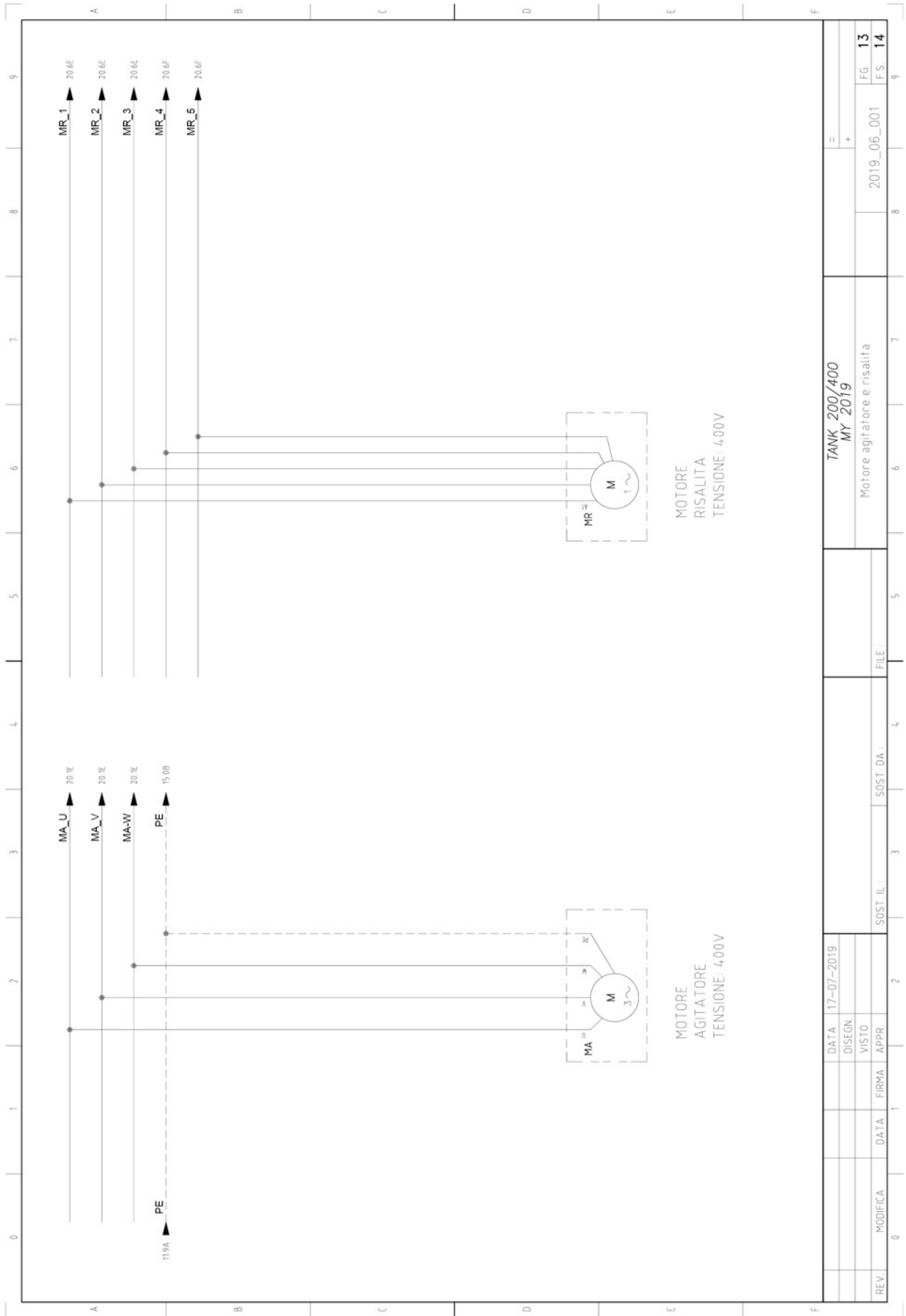

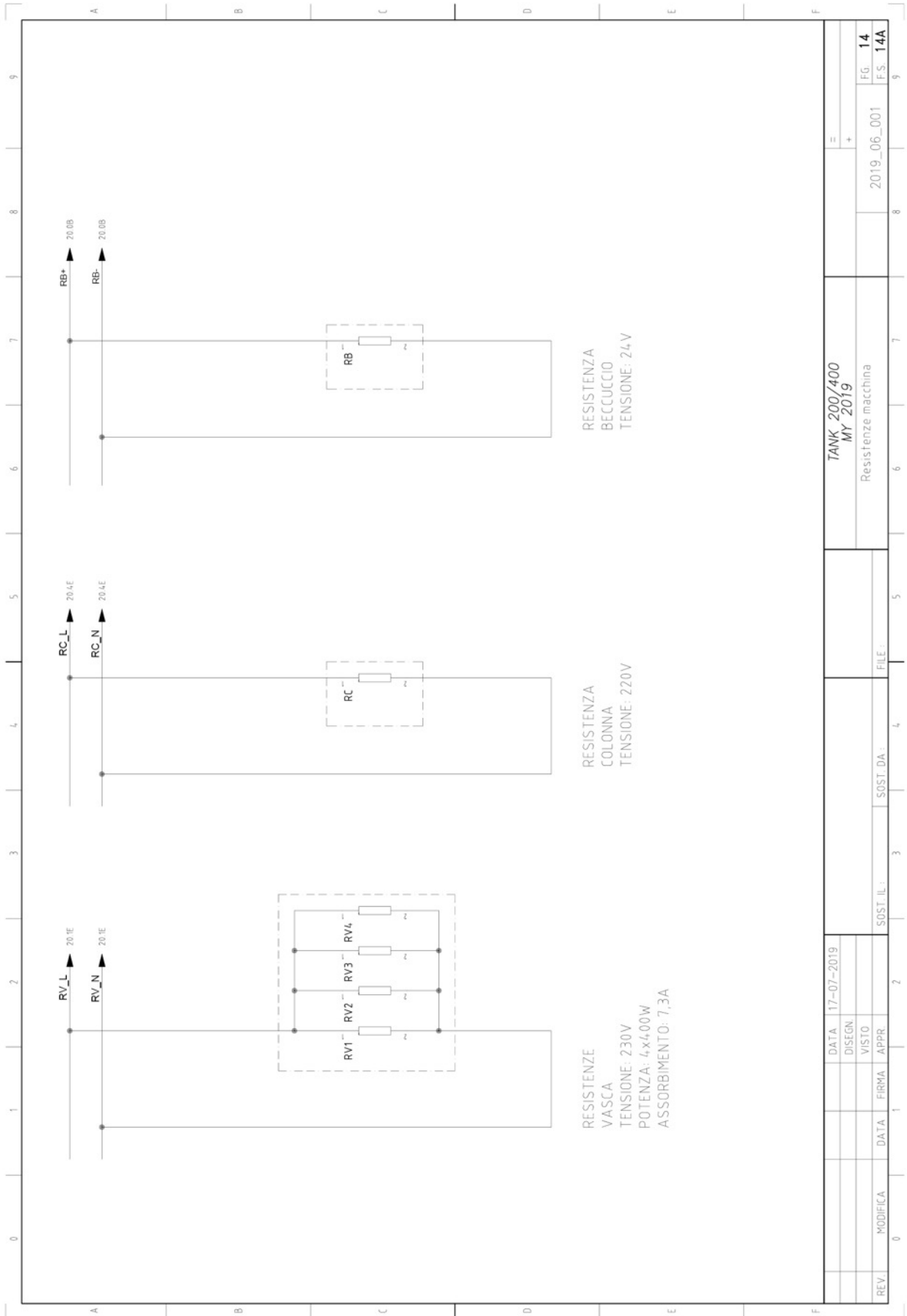

REV.	MODIFICA	DATA	FIRMA	APPR.	SOST. IL.:	SOST. DA.:	FILE:	TANK 200/400 MY 2019 Resistenze macchina	2019_06_001	FG. 14 F.S. 14A
------	----------	------	-------	-------	------------	------------	-------	--	-------------	--------------------

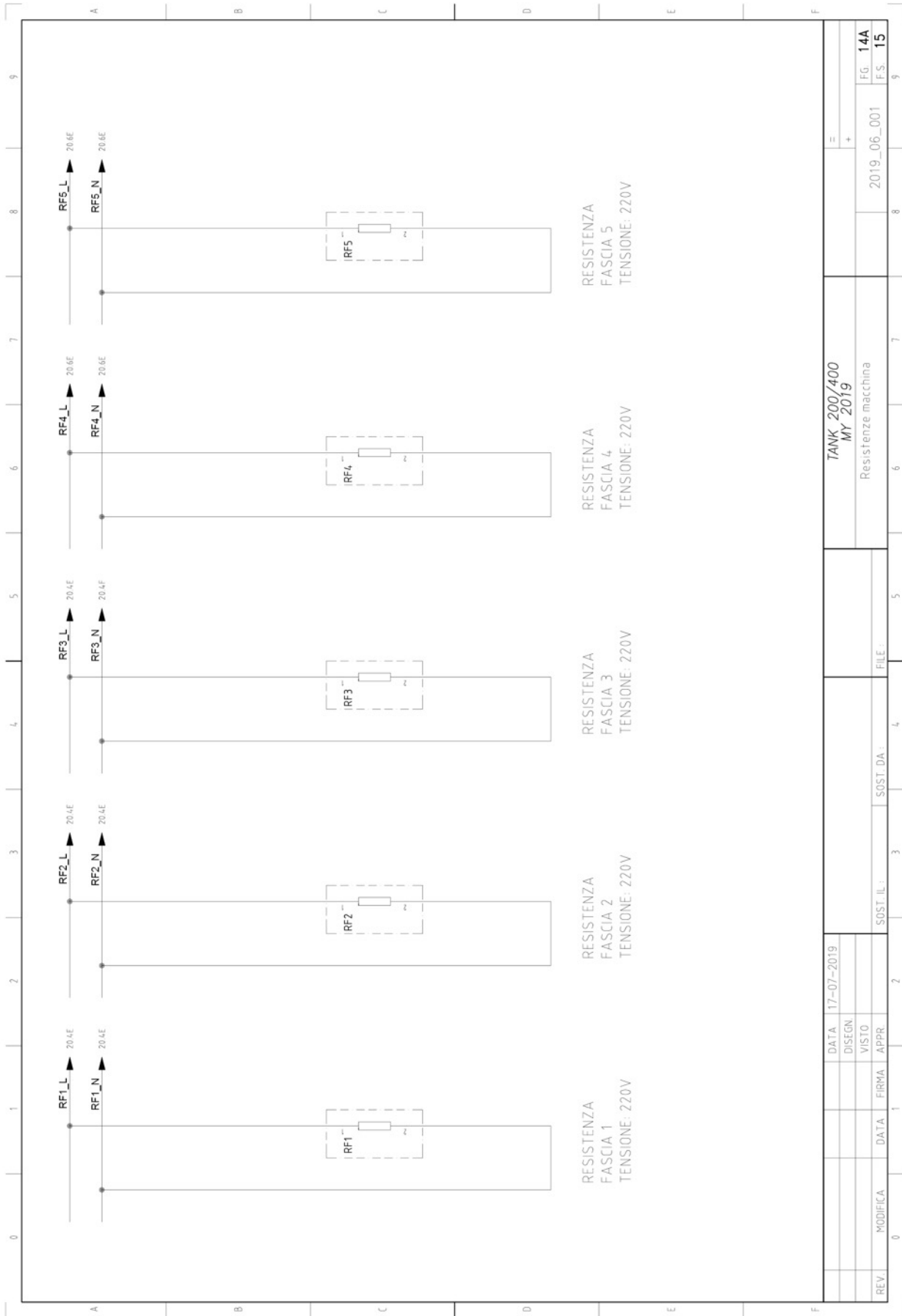

REV.	MODIFICA	DATA	FIRMA	APPR.	SOST. IL.:	SOST. DA.:	FILE :	TANK 200/400 MY 2019 Resistenze macchina	2019_06_001	FG. 14A F.S. 15
------	----------	------	-------	-------	------------	------------	--------	--	-------------	--------------------

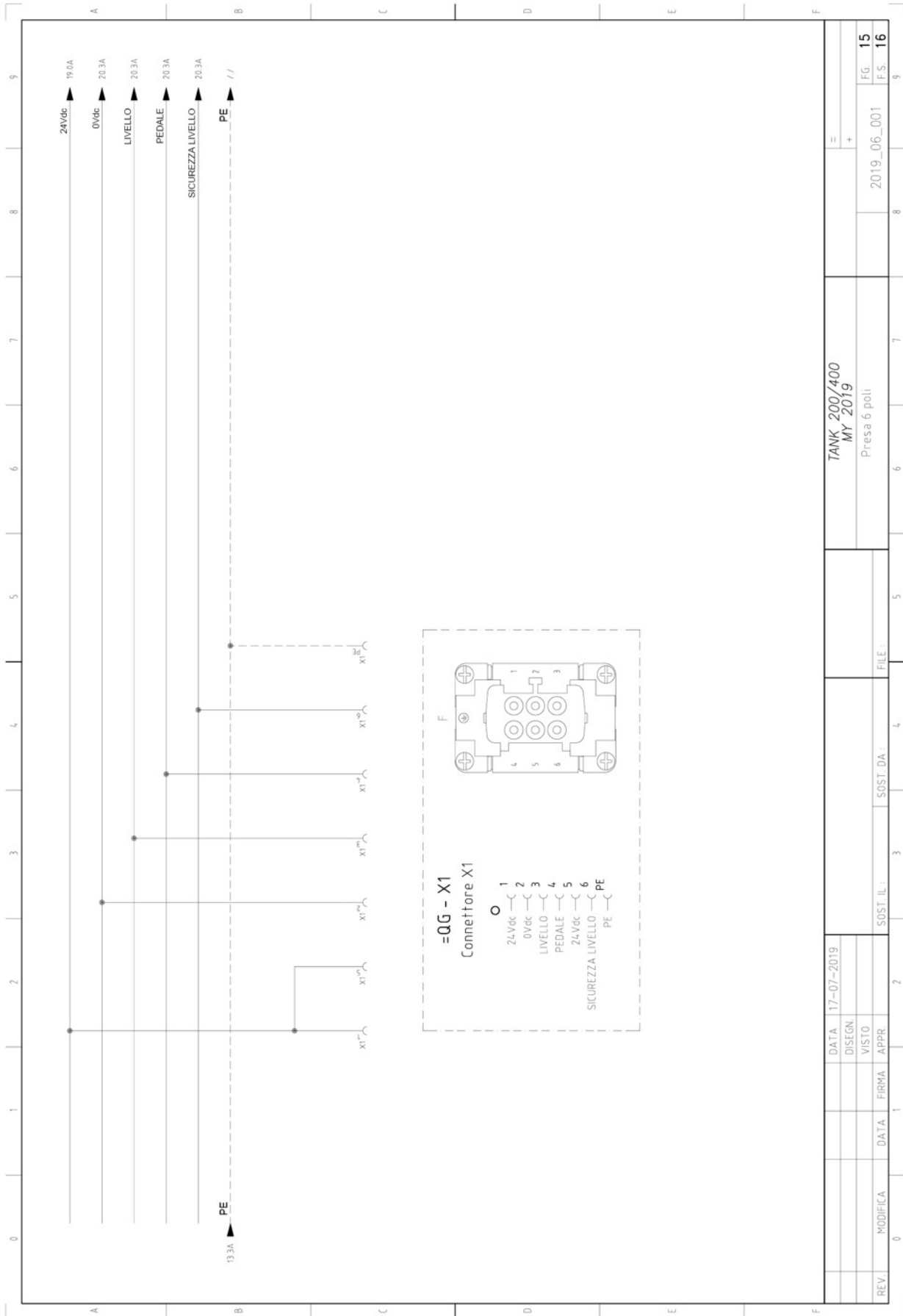

REV.	MODIFICA	DATA	FIRMA	APPR.	SOST. IL.:	SOST. DA.:	FILE:	TANK 200/400 MY 2019 Presse 6 poli	2019_06_001	FG. 15 F.S. 16
------	----------	------	-------	-------	------------	------------	-------	--	-------------	-------------------

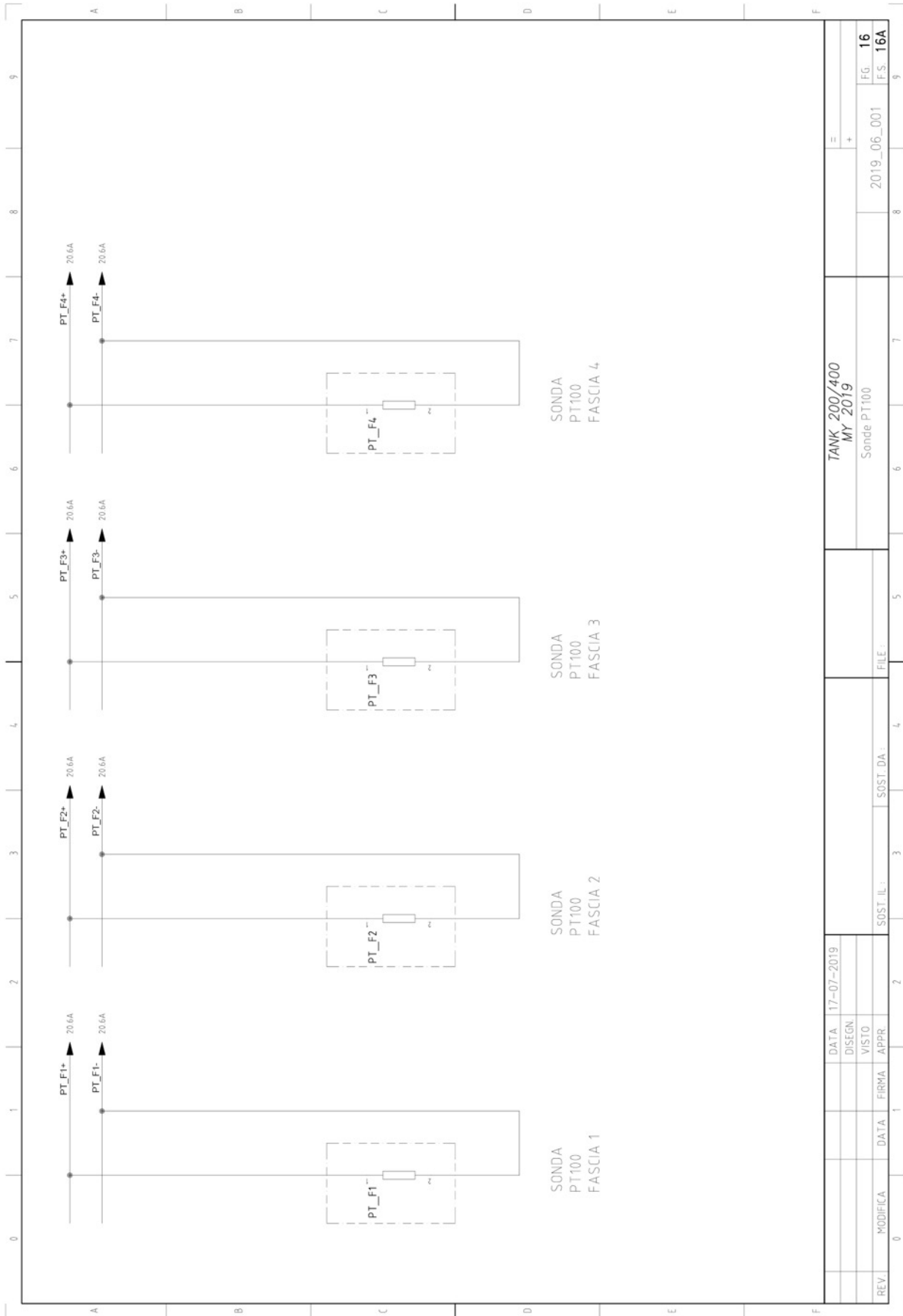

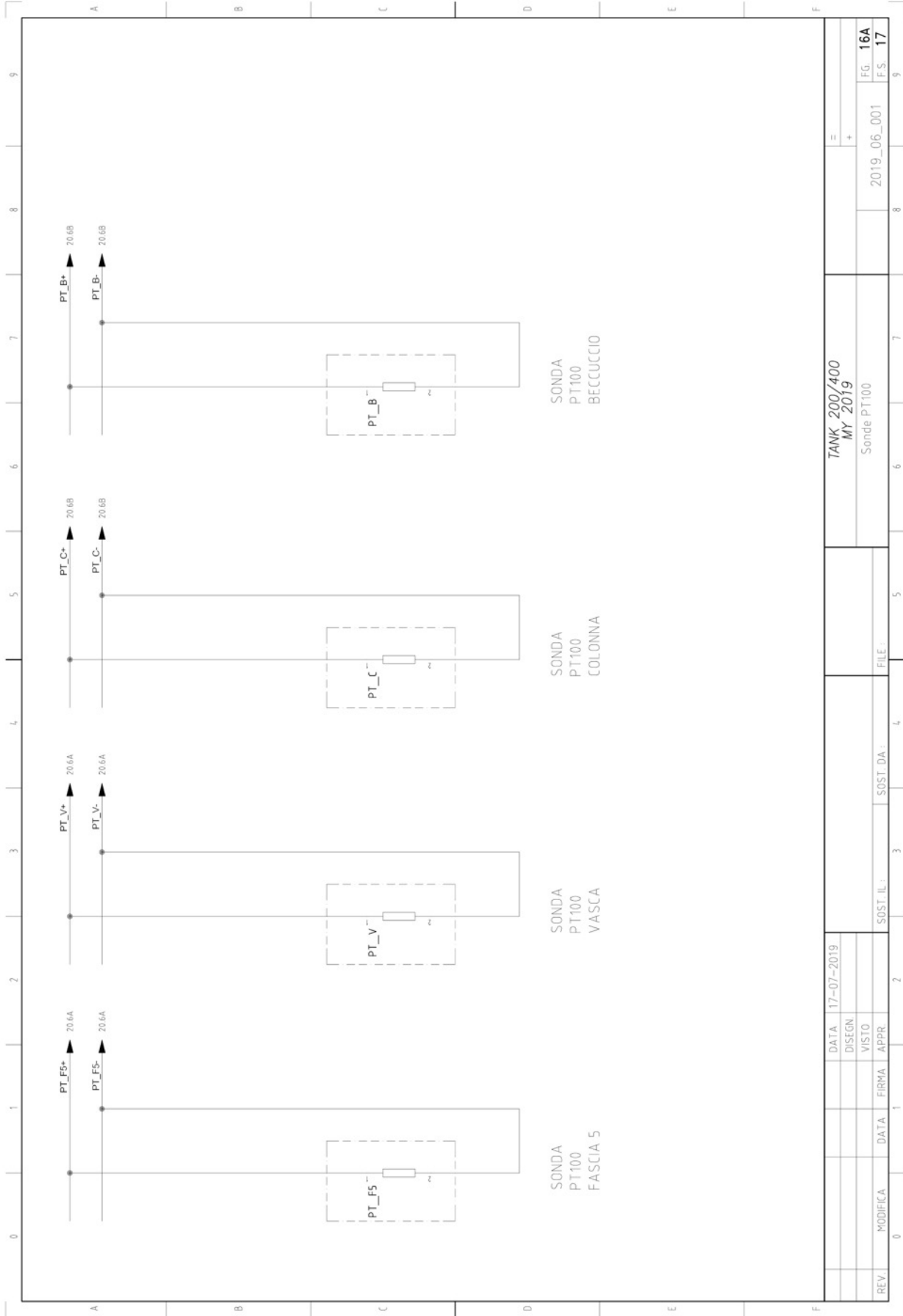

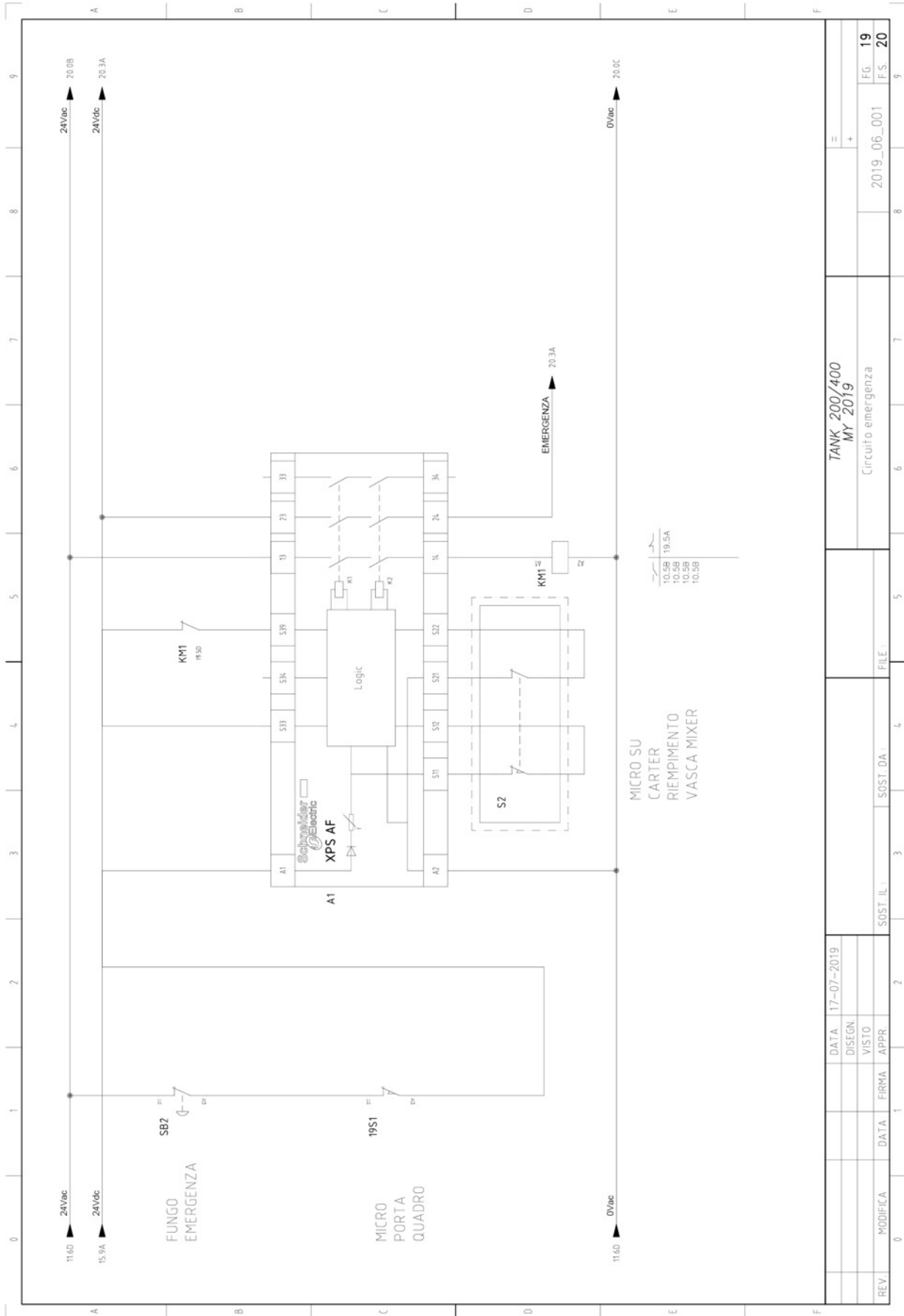



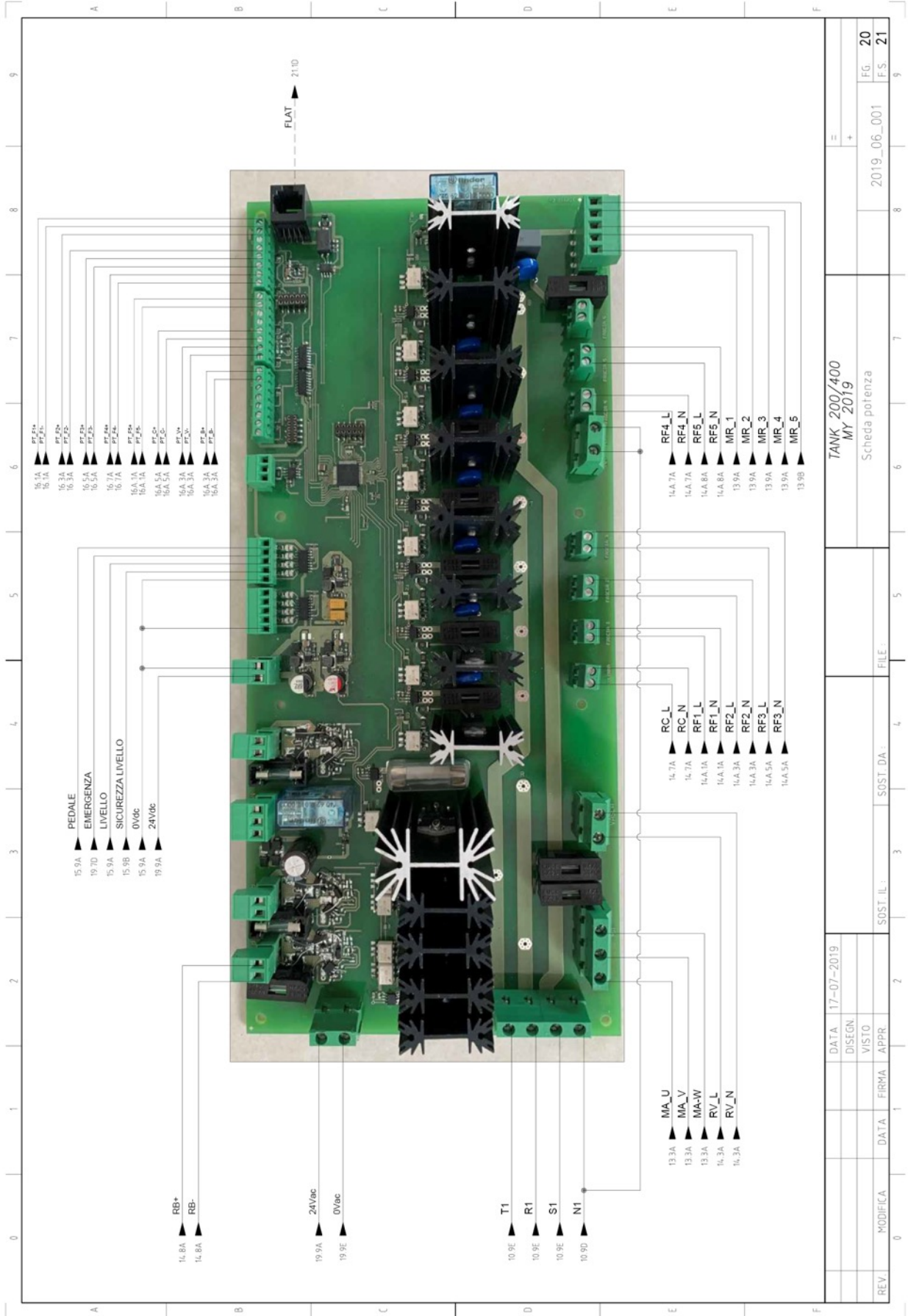

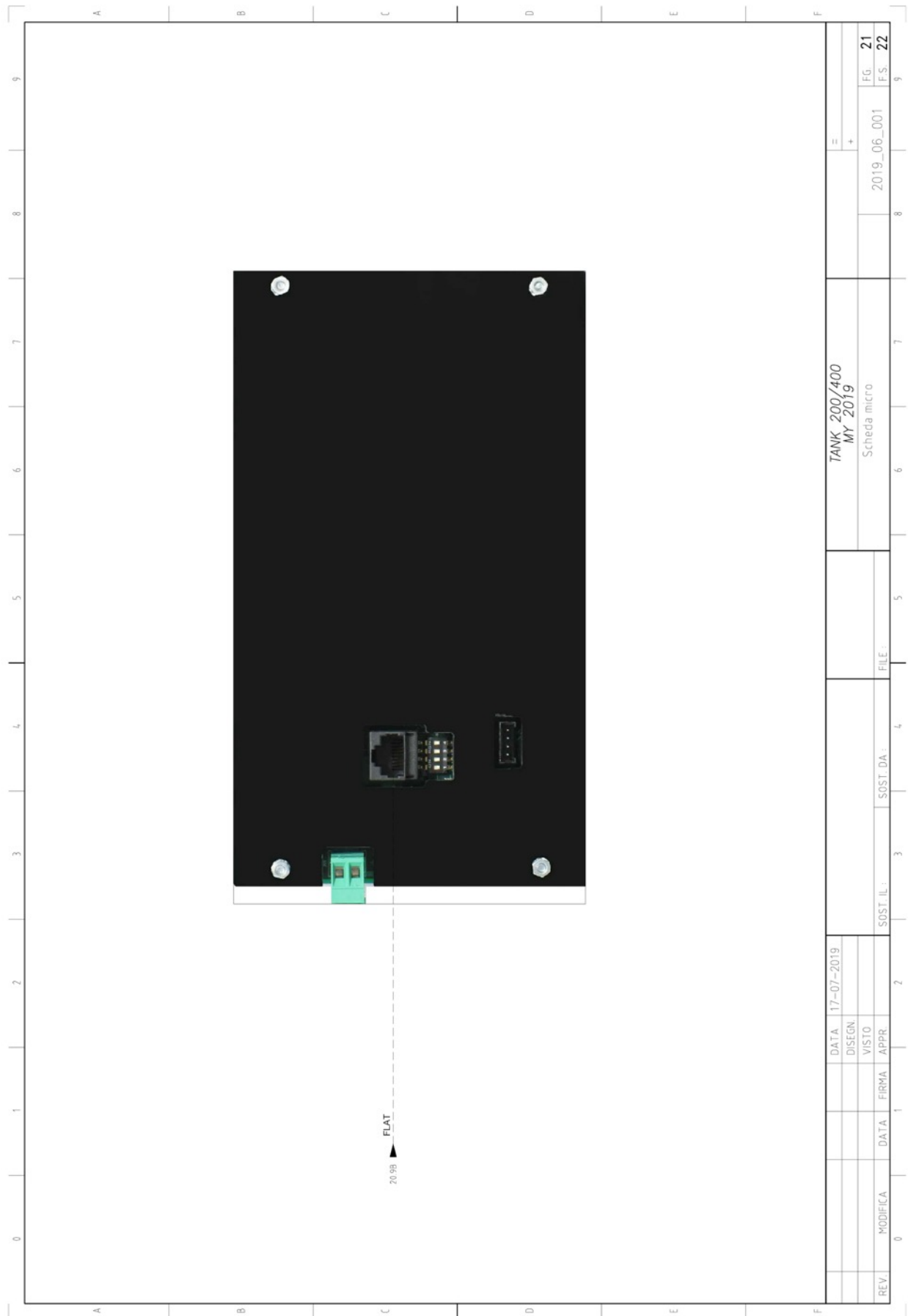



REV.	MODIFICA	DATA	FIRMA	APPR.	SOST. DA :	FILE :	TANK 200/400 MY 2019	2019_06_001	Fg. 19	F.S. 20
							Ciruito emergenza			







8. SPARE PARTS SECTION

	<p>TANK 001 Emergency button</p>		<p>TANK 010 Mixer reducer</p>
	<p>TANK 002 Touch screen</p>		<p>TANK 011 Mixer</p>
	<p>TANK 003 Display cable</p>		<p>TANK 012 Mixer vertical scraper</p>
	<p>TANK 004 Main contactor</p>		<p>TANK 013 Mixer bottom scraper</p>
	<p>TANK 005 Safety module</p>		<p>TANK 017 Micro security tank cover</p>
	<p>TANK 006 Power board</p>		<p>TANK 018 Micro security electrical panel door</p>
	<p>TANK 007 Transformer 224V/24V</p>		<p>TANK 022 Pump motor</p>
	<p>TANK 008 Sviwelling wheels</p>		<p>TANK 023 Pump reducer</p>
	<p>TANK 009 Mixer motor</p>		<p>TANK 024 Tank bottom temperature probe</p>

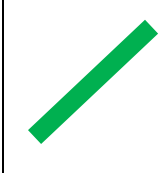
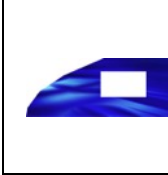
	TANK 028 Tank side resistance
	TANK 029 Tank bottom resistance
	TANK 030 Circulation pipe resistance 24V
	TANK 025 Tank side temperature probe
	TANK 026 Pump temperature probe
	TANK 027 Product temperature probe
	TANK 027 Mixer transmission pinion

	TANK 027 Mixer transmission chain
	TANK 027 Mixer transmission chain holder
	TANK 027 Control panel cover
	TANK 027 Tank cover